



#### Features

- Integral flange.
- Left drain.
- Integral lumbar support and armrests for comfort.
- Textured bottom surface.
- Integral apron.
- Coordinates with other products in the Devonshire® collection.
- 60" (1524 mm) x 32" (813 mm) x 20" (508 mm)

#### Material

- Acrylic

#### Installation

- Alcove

#### Recommended Accessories

- K-7161-AF Bath Drain
- K-7213 27" Cable Bath Drain
- K-7214 27" Cable Bath Drain
- K-7259 Clearflo Bath Drain
- K-37380 30" Rough-in Cable Bath Drain
- K-37383 30" Rough-in Cable Bath Drain
- K-702200-G54 Frameless Sliding Bath Door
- K-702200-G73 Frameless Sliding Bath Door
- K-702200-L Frameless Sliding Bath Door
- K-702205-L Frameless Sliding Bath Door
- K-706000-D3 Frameless Sliding Bath Door
- K-706000-L Frameless Sliding Bath Door
- K-706003-L Frameless Sliding Bath Door
- K-706004-D3 Frameless Sliding Bath Door
- K-706004-L Frameless Sliding Bath Door
- K-706007-L Frameless Sliding Bath Door



#### Codes/Standards





CSA B45.5/IAPMO Z124  
Greenguard UL 2818 - Gold

#### KOHLER® Plastic Baths and Receptors Lifetime Limited Warranty

See website for detailed warranty information.

#### Available Color/Finishes

*Color tiles intended for reference only.*

Color	Code	Description
	0	White
	96	Biscuit
	47	Almond
	NY	Dune
	G9	Sandbar

No change in measurements if connected with drain illustrated. (K-7161-AF)

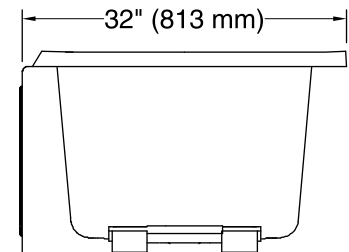
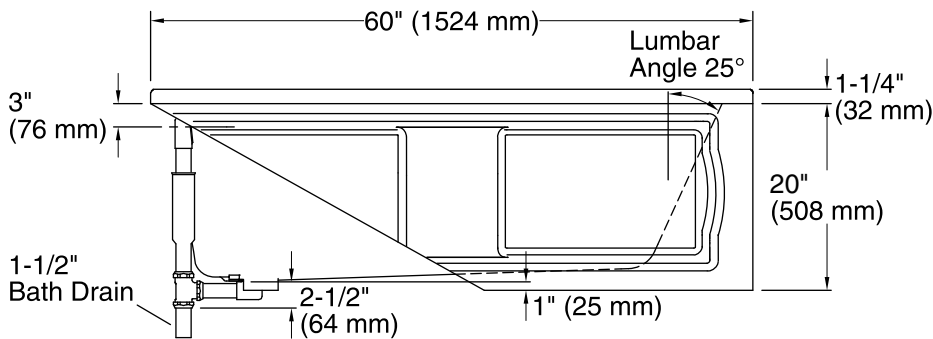
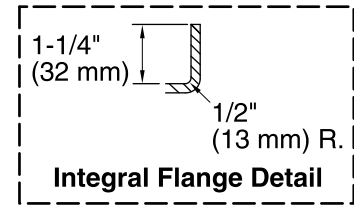
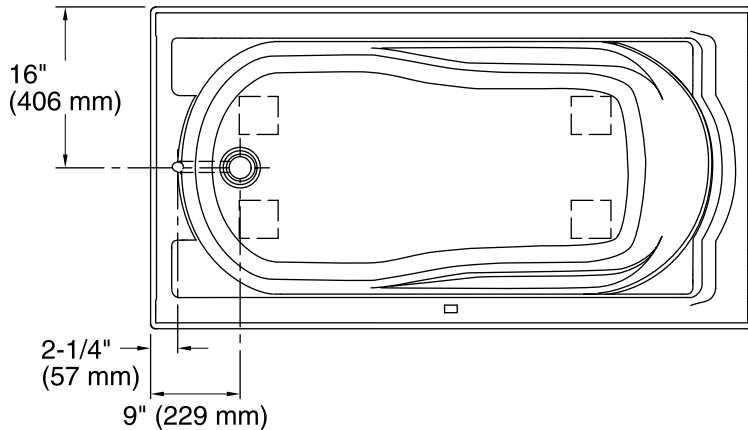

### Technical Information

All product dimensions are nominal.

Installation:	3-Wall Alcove
Drain location:	Left
Basin area, bottom:	42" x 20" (1067 mm x 508 mm)
Basin area, top:	51" x 24" (1295 mm x 610 mm)
Weight:	80 lbs (36.3 kg)
Minimum floor load:	41 lbs/ft <sup>2</sup> (200.2 kg/m <sup>2</sup> )
Water depth:	14" (356 mm)
Water capacity:	60 gal (227.1 L)
Minimum flat for door:	2-1/2" (64 mm)

### Notes

Measure your actual product for rough-in details. Install this product according to the installation instructions. The hot water supply should be 70% of the capacity of the bath or greater. Installations will vary.