



R32 SINGLE-ZONE EXTENDED PIPING WALL-MOUNTED ENGINEERING MANUAL



Extended Piping
KSSAP241A (24,000 Btu/h)



Extended Piping
KSSAP301A (30,000 Btu/h)
KSSAP361A (36,000 Btu/h)

PROPRIETARY DATA NOTICE

**This document, as well as all reports, illustrations, data, information, and other materials are the property of LG Electronics U.S.A., Inc., and are disclosed by LG Electronics U.S.A., Inc. only in confidence.
This document is for design purposes only.**

A summary list of safety precautions is on page 6.

For more technical materials such as submittals, catalogs, installation, owner's, and service manuals, visit www.lghvac.com.

Proper sizing and installation of equipment is critical to achieve optimal performance. Split system air conditioners and heat pumps (excluding ductless systems) must be matched with appropriate coil components to meet ENERGY STAR® criteria. Ask your contractor for details or visit www.energystar.gov.

(ENERGY STAR and the ENERGY STAR mark are registered trademarks owned by the U.S. Environmental Protection Agency.)

For continual product development, LG Electronics U.S.A., Inc., reserves the right to change specifications without notice.

© LG Electronics U.S.A., Inc.

This document, as well as all reports, illustrations, data, information, and other materials are the property of LG Electronics U.S.A., Inc.

LG AIR CONDITIONER TECHNICAL SOLUTION (LATS)

LG Air Conditioner Technical Solution (LATS) Software

A properly designed and installed refrigerant piping system is critical to the optimal performance of LG air-conditioning systems. To assist engineers, LG offers, free of charge, LG Air Conditioner Technical Solution (LATS) software—a total design solution for LG air conditioning systems. Contact your LG Rep for the best software program for your application.

NOTICE

To reduce the risk of designing an improper applied system or one that will not operate correctly, LG requires that LATS software be used on all projects.

Formats

LATS is available to LG customers in two user interfaces: LATS HVAC and LATS Revit. Both LATS formats are available through www.myLGHVAC.com, or contact an LG Sales Representative.

LATS HVAC is a Windows®-based application that aids engineers in designing LG Variable Refrigerant Flow (VRF), Multi F / Multi F MAX, Single-Zone, DOAS, and Energy Recovery Ventilator (ERV) systems.

*Windows® is a registered mark of Microsoft® Corporation.

LATS Revit integrates the LG LATS program with Revit® software**. It permits engineers to layout and validate LG VRF, Multi F / Multi F MAX, Single-Zone, and DOAS directly into Revit drawings.

**Revit® is a registered mark of Autodesk, Inc.

Features

All LG product design criteria have been loaded into the program, making LATS simple to use: double click or drag and drop the component choices. Build systems in Tree Mode where the refrigerant system can be viewed. Switch to a Schematic diagram to see the electrical and communications wiring.

LATS software permits the user to input region data, indoor and outdoor design temperatures, modify humidity default values, zoning, specify type and size of outdoor units and indoor units, and input air flow and external static pressure (ESP) for ducted indoor units.

The program can also:

- Import building loads from a separate Excel file.
- Present options for outdoor unit auto selection.
- Automatically calculate component capacity based on design conditions for the chosen region.
- Verify if the height differences between the various system components are within system limits.
- Provide the correct size of each refrigerant piping segment and LG Y-Branches and Headers.
- Adjust overall piping system length when elbows are added.
- Check for component piping limitations and flag if any parameters are broken.
- Factor operation and capacity for defrost operation.
- Calculate refrigerant charge, noting any additional trim charge.
- Suggest accessories for indoor units and outdoor units.
- Run system simulation.

NOTICE

Features depend on which LATS program is being used, and the type of system being designed. Contact your LG representative for the best software program for your application.

NOTICE

Any field changes, such as re-routing, shortening or lengthening a pipe segment, adding or eliminating elbows and/or fittings, re-sizing, adding, or eliminating indoor units, changing the mounting height, or moving the location of a device or fitting during installation must be done with caution and ALWAYS VERIFIED in LATS SOFTWARE BEFORE supplies are purchased or installed. Doing so will lead to a more profitable installation, reduce the potential for rework, and will reduce the potential for multiple visits to the job site to complete the system set up.

Figure 1: LATS Example (Tree Diagram; Illustrative Purposes Only. System will Vary Depending On Model).



LG AIR CONDITIONER TECHNICAL SOLUTION (LATS)

LATS Generates a Complete Project Report

LATS software also generates a report containing project design parameters, cooling and heating design data, system component performance, and capacity data. The report includes system combination ratio and refrigerant charge calculations; and provides detailed bill of material, including outdoor units, indoor units, control devices, accessories, refrigerant pipe sizes segregated by building, by system, by pipe size, and by pipe segments. LATS can generate an Excel GERP report that can be imported into the LG SOPS pricing and ordering system.

Proper Design to Install Procedure

LG encourages a two report design-to-install-procedure. After the design engineer determines building / zone loads and other details, the engineer opens the LATS program and inputs the project's information. When the design is complete, the "Auto Piping" and "System Check" functions must be used to verify piping sizes, limitations, and if any design errors are present. If errors are found, engineers must adjust the design, and run Auto Piping and System Check again. When the design passes the checks, then the engineer prints out a project "Shop Drawing" (LATS Tree Diagram) and provides it to the installing contractor. The contractor must follow the LATS Tree Diagram when building the piping system, but oftentimes the design changes on the building site:

- Architect has changed location and/or purpose of room(s).
- Outdoor unit cannot be placed where originally intended.
- Structural elements prevent routing the piping as planned.
- Air conditioning system conflicts with other building systems (plumbing, gas lines, etc.).

The contractor must mark any deviation from the design on the Shop Drawing, including as-built straight lines and elbows. This "Mark Up" drawing must be returned to the design engineer or Rep, who must input contractor changes into the LATS file. (Copy the original LATS software file, save and rename as a separate file, and modify all piping lengths by double-clicking on each length and editing information.) Like the shop drawing, the Auto Piping and System Check must also be run on this new "As Built" drawing. The design engineer or Rep must then provide the final As Built file to the contractor. The Mark Up version must be compared to the As Built version for:

- Differences in pipe diameter(s). If incorrect diameters have been installed, the piping must be changed out. If pipe diameters have changed, check if Y-Branched will also need to be changed.
- Changes to outdoor unit and indoor unit capacities. Capacities changes will impact line length changes.
- Additional refrigerant charge quantity ("Trim Charge"). Trim charge will change if piping lengths and diameters change. The As Built version must reflect installed piping lengths to ensure correct trim charge.

All documents submitted by the contractor, as well as the Shop Drawing and the As Built Drawing files must be provided for commissioning purposes. Model and serial numbers for all system components must also be submitted. If the steps previously detailed are not followed, and all documents are not provided to the commissioning agent, the project runs the risk of not being commissioned and voiding any limited warranty LG offers on the equipment.



NOTICE

Any field changes, such as re-routing, shortening or lengthening a pipe segment, adding or eliminating elbows and/or fittings, re-sizing, adding, or eliminating indoor units, changing the mounting height, or moving the location of a device or fitting during installation must be done with caution and ALWAYS VERIFIED in LATS SOFTWARE BEFORE supplies are purchased or installed. Doing so will lead to a more profitable installation, reduce the potential for rework, and will reduce the potential for multiple visits to the job site to complete the system commissioning.

TABLE OF CONTENTS

LG Air Conditioner Technical Solution (LATS)	3-4
Table of Symbols	6
Product Data	7-29
<i>Unit Nomenclature</i>	8
<i>Pairing Table</i>	9
<i>Mechanical Specifications</i>	10
<i>General Data</i>	11-12
<i>Electrical Data</i>	13
<i>Functions, Controls, Options</i>	14-15
<i>Accessories</i>	16-17
<i>Outdoor Unit Dimensions</i>	18
<i>Outdoor Unit Center of Gravity / Corner Weight</i>	19
<i>Indoor Unit Dimensions</i>	20-21
<i>Indoor Unit Air Flow, Temp. Distribution Graphs</i>	22-27
<i>Acoustic Data</i>	28-29
Performance Data	30-44
<i>Cooling Capacity</i>	31-33
<i>Maximum Cooling Capacity</i>	34-36
<i>Heating Capacity</i>	37-39
<i>Maximum Heating Capacity</i>	40-42
<i>Correction Factors</i>	43-44
<i>Check Selection</i>	44
Application Guidelines	45-53
<i>Indoor Unit Placement / Clearance Considerations</i>	46-47
<i>Outdoor Unit Placement / Clearance Considerations</i>	47-50
<i>Installing Outdoor Units Indoors</i>	51-53
Refrigerant Piping Design	54-64
<i>Refrigerant Flow Diagrams</i>	55-56
<i>Connection Limitations and System Layout</i>	57
<i>Additional Refrigerant Charge</i>	58
<i>Refrigerant Piping System Engineering</i>	59-64
Electrical	65-72
<i>General Guidelines</i>	66
<i>Wiring Diagrams</i>	67-68
<i>Power Supply / Power Wiring</i>	69
<i>Communication / Connection Cable</i>	70
<i>Controllers</i>	71-72
Limited Warranty	73

TABLE OF SYMBOLS

	Indicates that this appliance uses a flammable refrigerant. If the refrigerant leaks and is exposed to an external ignition source, there is a risk of fire.
⚠ DANGER	Indicates a hazardous situation that, if not avoided, WILL RESULT IN DEATH OR SERIOUS INJURY. ¹
⚠ WARNING	Indicates a hazardous situation that, if not avoided, COULD RESULT IN DEATH OR SERIOUS INJURY. ¹
⚠ CAUTION	Indicates a hazardous situation that, if not avoided, COULD RESULT IN MINOR OR MODERATE INJURY. ¹
NOTICE	Indicates information considered important, but not hazard-related; indicates situations that may result in equipment or property damage accidents. ¹
	This symbol indicates an action that should not be performed.

¹Signal words, symbols, and definitions taken from American National Standards Institute (ANSI) Z535.6. See <https://www.ansi.org/> for more information.



R32 Refrigerant



LG Electronic split system heating and air conditioning (HVAC) products now contain R32 refrigerant. While R32 refrigerant is slightly flammable, it has a higher efficiency, a lower Global Warming Potential (GWP) value, and is more environmentally friendly than R410A.

R32 Ozone Depletion Potential (ODP) Value: 0.



R32 Global Warming Potential (GWP) Value: 675.

The amount of refrigerant depends on outdoor unit to indoor unit configuration. All refrigerant piping system components (copper piping, joints, and other fittings) must be selected and installed to conform with Refrigeration Safety Regulation standards. Use LG Air Conditioner Technical Solution (LATS) Software to verify the refrigerant amount needed for each installation.

⚠ WARNING

- This HVAC system contains fluorinated greenhouse gases in the form of R32 refrigerant.  Do not leak refrigerant gas into the atmosphere.
- Only use R32 as the refrigerant in these HVAC systems. If other substances are added, it may cause an explosion.
- R32 refrigerant is slightly flammable. When handled properly, it does not leak. If the refrigerant leaks in the installation area and comes in contact with a flame, it may generate a fire and / or harmful gas.
- If a leak occurs, immediately turn off any combustion devices, ventilate the installation area, and contact the dealer / contractor where the HVAC unit was purchased.  Do not operate the unit until the refrigerant leaked is repaired.

⚠ CAUTION

- Piping wall thickness must comply with all applicable local, state, and federal regulations for the design pressures listed by the manufacturer.  Unapproved piping must not be used.
- To prevent piping from softening,  do not heat the piping more than necessary.

PRODUCT DATA

Unit Nomenclature on page 8

Pairing Table on Page 9

Mechanical Specifications on page 10

General Data on page 11

Electrical Data on page 13

Functions, Controls, and Options on page 14

Accessories on page 16

Outdoor Unit Dimensions on page 18

Outdoor Unit Center of Gravity / Corner Weight on page 19

Indoor Unit Dimensions on page 20

Air Flow, Temperature Distribution Graphs on page 22

Acoustic Data on page 28



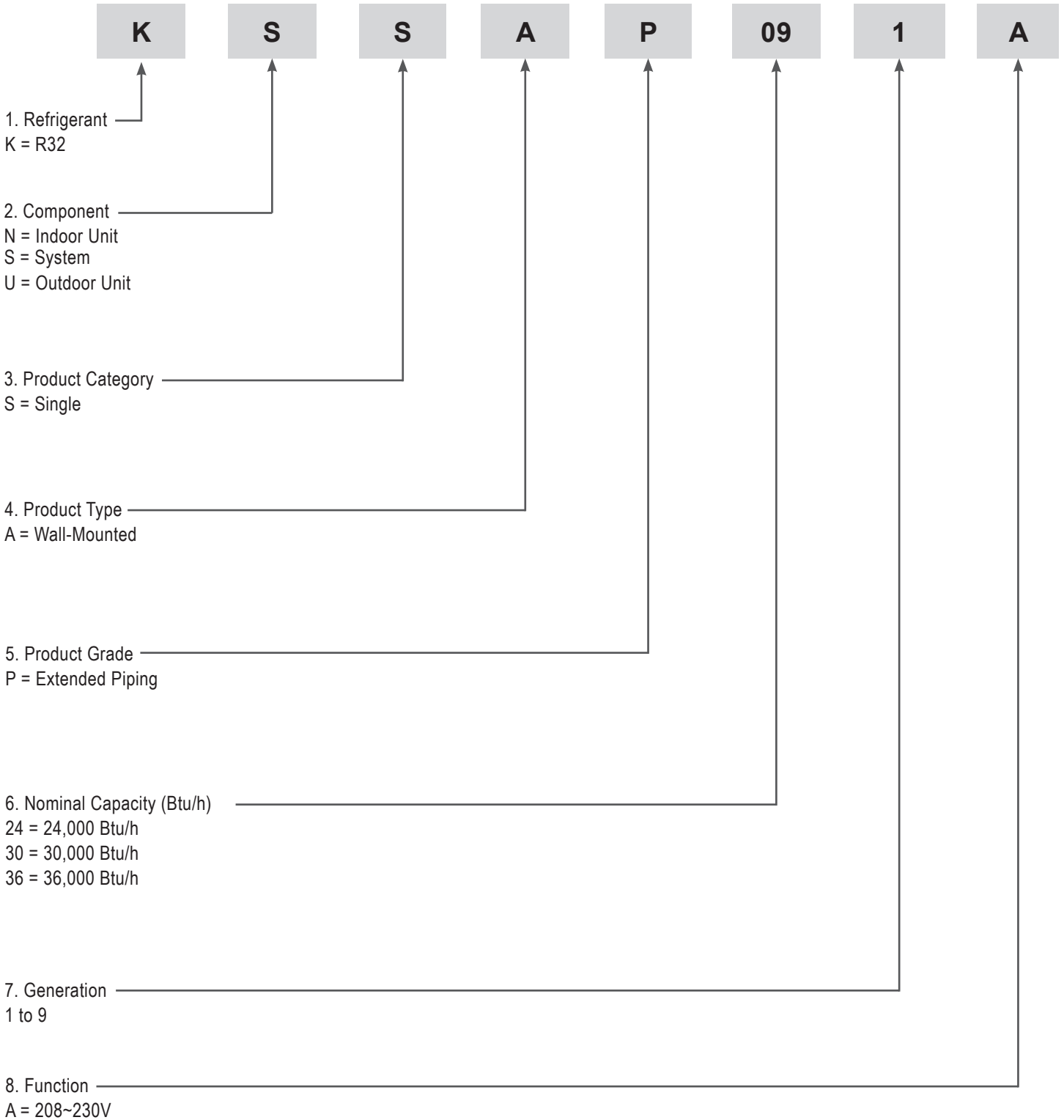



UNIT NOMENCLATURE



PAIRING TABLE

The following tables show the available outdoor and indoor units, along with the factory provided controllers.

Table 1: Single-Zone Extended Piping Wall-Mounted System Pairing Table.

Outdoor Unit Model	Indoor Unit Model	Controller
<p data-bbox="269 472 396 499">KUSAP241A</p> 	<p data-bbox="745 472 878 499">KNSAP241A</p> 	<p data-bbox="1216 472 1365 499">AKB76044208</p> 
<p data-bbox="199 846 464 873">KUSAP301A, KUSAP361A</p> 	<p data-bbox="678 846 943 873">KNSAP301A, KNSAP361A</p> 	<p data-bbox="1216 846 1365 873">AKB76044208</p> 

Product Data

MECHANICAL SPECIFICATIONS

General

LG Single Zone Wall Mounted Extended Piping systems are comprised of a single outdoor unit connected to a single indoor unit with a single refrigerant circuit.

These single zone systems can operate in either cooling or heating mode. These systems are capable of changing mode within a maximum time of three (3) minutes to ensure temperature can be properly maintained.

LG components are manufactured in a facility registered to ISO 9001 and ISO 14001, which is a set of standards applying to environmental protection set by the International Organization for Standardization (ISO). Wiring in these units are in accordance with the National Electrical Code (NEC).

Temperature Ranges

Outdoor Unit

Operating ranges for outdoor units of 14°F to 118°F DB for cooling and -4°F to 65°F WB for heating.

Installing an optional Low Ambient Wind Baffle Kit will allow operation down to 0°F in cooling mode.

Indoor Unit

Operating ranges for indoor units of 53°F to 75°F WB for cooling and 60°F to 86°F DB for heating.

Casing / Frame

Outdoor unit is constructed with pre-coated metal (PCM).

Indoor unit is constructed of heavy duty Acrylonitrile Butadiene Styrene (ABS) and High Impact Polystyrene (HIPS) plastic.

Refrigerant System

The refrigeration system consists of a single refrigeration circuit and uses R32 refrigerant. The outdoor unit is provided with factory installed components, including a refrigerant strainer, four-way reversing valve, electronic controlled expansion valve (EEV), high and low side charging ports, service valves, and interconnecting piping.

Refrigeration Oil Control

Heat pump outdoor units have a centrifugal oil separator and controls to ensure sufficient oil supply is maintained, and that oil does not travel with the refrigerant.

Compressors

The outdoor unit is equipped with one hermetic digitally controlled inverter driven twin rotary compressor to modulate capacity (modulation in 1 Hz increments).

Frequency ranges for the outdoor units are as follows:

KUSAP241A: 10 Hz ~ 70 Hz for Cooling, 10 Hz ~ 100 Hz for Heating;

KUSAP301A: 10 Hz ~ 61 Hz for Cooling, 10 Hz ~ 90 Hz for Heating;

KUSAP361A: 10 Hz ~ 64 Hz for Cooling, 10 Hz ~ 90 Hz for Heating.

Overcurrent protection and vibration isolation are integrated with the compressor.

Outdoor Unit Coil

Heat pump outdoor unit coils are made of a nonferrous construction with louvered fins on copper tubing, and are protected with an integral coil guard. Coil fins have a factory applied corrosion resistant GoldFin™ material with hydrophilic coating. Outdoor units include factory-installed drain pan heaters.

Fans and Motors

The outdoor unit includes one direct fan drive, variable speed variable speed propeller type fan. The Brushless Digitally Controlled (BLDC) fan motor included inherent protection, permanently lubricated bearings, and variable speed with speeds:

KUSAP241A: 190 ~ 750 rpm for Cooling, 190 ~ 750 rpm for Heating;

KUSAP301A: 190 ~ 750 rpm for Cooling, 190 ~ 800 rpm for Heating;

KUSAP361A: 190 ~ 750 rpm for Cooling, 190 ~ 800 rpm for Heating.

Raised guards are provided to limit contact with moving parts. The outdoor unit has horizontal discharge airflow.

Electrical

These units are available in 208-230V, 60 Hz, 1-phase power supply. These units are capable of operating within voltage limits of $\pm 10\%$ rated voltage, and include overcurrent protection.

Controls

The indoor unit casing has a factory-standard, integral, infrared sensor designed to communicate with the supplied LG wireless handheld remote controller. An optional LG supplied wired controller is available as an additional accessory. Communication between the indoor unit and the outdoor unit is accomplished through 14 AWG four-core, stranded, shielded power / communication cable.

Extended Piping indoor units have built-in Wi-fi and can be controlled by LG's Smart ThinQ™ app on a smartphone. A field-supplied Wi-Fi network and smart device are required. The Smart ThinQ app is free, and is available for Android™ and iOS. (Android is a trademark of Google LLC.)

Figure 2: KSSAP301A and KSSAP361A Extended Piping Wall Mounted System.



GENERAL DATA

Table 2: Single-Zone Extended Piping System Specifications.

System (Model) (Indoor Unit / Outdoor Unit)		KSSAP241A (KNSAP241A / KUSAP241A)	KSSAP301A (KNSAP301A / KUSAP301A)	KSSAP361A (KNSAP361A / KUSAP361A)
Cooling Capacity (Min/Rated/Max) (Btu/h)		3,070~22,000~30,000	3,070~30,000~32,000	3,070~33,000~34,000
Cooling Power Input ¹ (Min/Rated/Max) (kW)		0.4~1.692~3.170	0.5~2.654~3.60	0.5~3.30~4.020
EER2 (@95°F)		13.0	11.3	10.0
SEER2		22.0	21.0	20.0
Heating Capacity (Min/Rated/Max) (Btu/h)		3,070~24,000~30,800	3,070~32,400~36,500	3,070~35,200~38,900
Heating Power Input ¹ (Min/Rated/Max) (kW)		0.660~1.920~3.240	0.660~2.592~4.100	0.660~2.933~4.370
COP (@47°F)		3.66	3.66	3.52
HSPF2		9.7	8.5	8.5
<i>Rated Low Heating Capacity (Btu/h)</i>				
Outdoor 17°F (WB)/Indoor 70°F (DB)		15,800	19,700	21,400
Low COP (@17°F)		2.70	2.70	2.60
<i>Maximum Heating Capacity (Btu/h)</i>				
Outdoor 17°F (WB)/Indoor 70°F (DB)		23,210 (97%)	27,500 (85%)	30,000 (85%)
Outdoor 5°F (WB)/Indoor 70°F (DB)		20,000 (83%)	24,000 (74%)	26,000 (74%)
Outdoor 0°F (WB)/Indoor 70°F (DB)		17,800 (74%)	21,500 (66%)	23,210 (66%)
Outdoor -4°F (WB)/Indoor 70°F (DB)		16,580 (69%)	20,030 (62%)	21,620 (61%)
ENERGY STAR / Cold Climate		Yes / Yes	No / No	No / No
Power Supply (V/Hz/Ø) ²		208-230 / 60 / 1		
Power/Communication Cable ³ (No. x AWG)		4 x 14	4 x 14	4 x 14
<i>Indoor Unit Data</i>				
Operating Range	Cooling (°F WB)	53 to 75		
	Heating (°F DB)	60 to 86		
Temperature Setting Range	Cooling (°F)	64 to 86		
	Heating (°F)	60 to 86		
Sound Pressure ⁴ dB(A)	Cooling (H/M/L/SL)	49 / 44 / 40 / 30	51 / 47 / 43 / 33	51 / 47 / 43 / 33
	Heating (H/M/L)	49 / 44 / 40	51 / 47 / 43	51 / 47 / 43
Net Dimensions (W x H x D) (in.)		41-23/32 x 14-3/16 x 10-7/16	47-1/4 x 14-3/16 x 10-7/16	47-1/4 x 14-3/16 x 10-7/16
Shipping Dimensions (W x H x D) (in.)		44-7/8 x 17-29/32 x 14-3/16	50-13/32 x 17-29/32 x 14-3/16	50-13/32 x 17-29/32 x 14-3/16
Net / Shipping Weight (lbs.)		36.6 / 44.5	40.8 / 48.9	40.8 / 48.9
Exterior Color Codes		Munsell 7.5BG 10/2 (RAL 9016)		
Fan Type x Qty.		Cross Flow x 1	Cross Flow x 1	Cross Flow x 1
Fan Motor Output (W) x Qty.		58 x 1	110 x 1	110 x 1
Fan Motor / Drive		Brushless Digitally Controlled / Direct		
Airflow Rate Max/H/M/L (CFM)	Cooling	813 / 601 / 495 / 389	1,095 / 883 / 742 / 601	1,095 / 883 / 742 / 601
	Heating	919 / 707 / 601 / 495	1,166 / 954 / 813 / 671	1,166 / 954 / 813 / 671
Dehumidification Rate (pts./hr.)		4.65	5.49	5.49

EEV: Electronic Expansion Valve IDU: Indoor Unit ODU: Outdoor Unit

This data is rated 0 feet above sea level with 24.6 feet of refrigerant line per indoor unit and a 0 foot level difference outdoor and indoor units.

Cooling capacity rating obtained with air entering the indoor unit at 80°F dry bulb (DB) and 67°F wet bulb (WB) and outdoor ambient conditions of 95°F dry bulb (DB) and 75°F wet bulb (WB).

Heating capacity rating obtained with air entering the indoor unit at 70°F dry bulb (DB) and 59°F wet bulb (WB) and outdoor ambient conditions of 47°F dry bulb (DB) and 43°F wet bulb (WB).

¹Power Input is rated at high speed.

²Power wiring to the ODU is field supplied, solid or stranded, and must comply with the applicable local and national codes.

³All power wiring/communication cables from outdoor unit to indoor unit are field supplied and are to be minimum 14 AWG, 4-conductor, stranded, shielded or unshielded (if shielded, must be grounded to chassis at outdoor unit only) and must comply with applicable local and national codes.

⁴Sound Pressure levels are tested in an anechoic chamber under ISO Standard 3745.

GENERAL DATA

Table 3: Single-Zone Extended Piping Specifications, continued.

System (Model) (Indoor Unit / Outdoor Unit)		KSSAP241A (KNSAP241A / KUSAP241A)	KSSAP301A (KNSAP301A / KUSAP301A)	KSSAP361A (KNSAP361A / KUSAP361A)
<i>Outdoor Unit Data</i>				
Operating Range ¹	Cooling (°F DB)	14 to 118 ¹		
	Heating (°F WB)	-4 to +65		
Sound Pressure ² dB(A)	Cooling	55	55	55
	Heating	56	58	58
Max. External Static Pressure (in. w.g.)		0.0409	0.048	0.048
Net Dimensions (W x H x D) (in.)		37-13/32 x 32-3/4 x 13	37-13/32 x 32-3/4 x 13	37-13/32 x 32-3/4 x 13
Shipping Dimensions (W x H x D) (in.)		44-7/8 x 36-5/32 x 17-29/32	44-7/8 x 36-5/32 x 17-29/32	44-7/8 x 36-5/32 x 17-29/32
Net / Shipping Weight (lbs.)		135.4 / 147.7	147.9 / 160.3	147.9 / 160.3
Exterior Color Codes		Munsell 9.54Y 8.34/1.31 (RAL 9001)		
Fan Type x Qty.		Propeller x 1	Propeller x 1	Propeller x 1
Fan Motor Output (W) x Qty.		124 x 1	124 x 1	124 x 1
Fan Motor / Drive		Brushless Digitally Controlled / Direct		
Airflow Rate Max. (CFM)		2,119	2,295	2,295
Compressor (Type x Qty.)		Twin Rotary x 1	Twin Rotary x 1	Twin Rotary x 1
<i>Heat Exchanger</i>				
Material and Fin Coating		Copper Tube / Aluminum Fin (Gold Fin™ Coating on Outdoor Unit Coil; N/A on Indoor Unit Coil)		
Rows / Columns / Fin per inch x Qty.		Outdoor Unit: (2 x 38 x 17) x 1; Indoor Unit: (3 x 18 x 21) x 1		
<i>Refrigerant</i>				
Type ³ / Control		R32 / EEV		
Pre-Charge (oz.)		65.3	70.5	70.5
Additional Charge (oz./ft.)		0.32	0.32	0.32
<i>Piping</i>				
Liquid (in.)	Connection / Pipe Size	3/8 Flare / 3/8 Flare	3/8 Flare / 3/8 Flare	3/8 Flare / 3/8 Flare
Vapor (in.)	Connection / Pipe Size	5/8 Flare / 5/8 Flare	5/8 Flare / 5/8 Flare	5/8 Flare / 5/8 Flare
Condensation Line (O.D., I.D., in.)		27/32, 5/8	27/32, 5/8	27/32, 5/8
Pipe Length ⁴ (Min./Standard/Max.) (ft.)		9.8 / 24.6 / 164.0	9.8 / 24.6 / 164.0	9.8 / 24.6 / 164.0
Piping Length ⁴ (no add'l refrigerant, ft.)		24.6	24.6	24.6
Max Elevation Difference (ft.)		98.4	98.4	98.4

EEV: Electronic Expansion Valve IDU: Indoor Unit ODU: Outdoor Unit
This data is rated 0 feet above sea level with 24.6 feet of refrigerant line per indoor unit and a 0 foot level difference outdoor and indoor units.

Cooling capacity rating obtained with air entering the indoor unit at 80°F dry bulb (DB) and 67°F wet bulb (WB) and outdoor ambient conditions of 95°F dry bulb (DB) and 75°F wet bulb (WB).
Heating capacity rating obtained with air entering the indoor unit at 70°F dry bulb (DB) and 59°F wet bulb (WB) and outdoor ambient conditions of 47°F dry bulb (DB) and 43°F wet bulb (WB).

¹Optional Low Ambient Wind Baffle Kit allows operation down to 0°F in cooling mode.

²Sound Pressure levels are tested in an anechoic chamber under ISO Standard 3745.

³Take appropriate actions at the end of HVAC equipment life to recover, recycle, reclaim or destroy R32 refrigerant according to applicable regulations (40 CFR Part 82, Subpart F) under section 608 of CAA.

⁴Piping lengths are equivalent.

ELECTRICAL DATA

Table 4: Single-Zone Extended Piping Wall-Mounted Electrical Data Table.

Nominal Tons	Unit Model No.	Phase	Hertz	Voltage	Voltage Range (Min. to Max.)	MCA	MOP	LRA	Compressor Quantity	Compressor Motor RLA	Condenser Fan Motor		Indoor Unit Fan Motor	
											W x Qty.	FLA	W	FLA
2	KSSAP241A	1	60	208 - 230	187 - 253	19.0	30.0	17.0	1	14.4	124 x 1	0.4	58	0.5
2-1/2	KSSAP301A					23.0	30.0	17.0		15.1	124 x 1	0.4	110	0.5
3	KSSAP361A					23.0	30.0	17.0		15.1	124 x 1	0.4	110	0.5

Voltage tolerance is ±10%.

Maximum allowable voltage unbalance is 2%.

MCA = Minimum Circuit Ampacity.

Maximum Overcurrent Protection (MOP) is calculated as follows: (Largest motor FLA x 2.25) + (Sum of other motor FLA) rounded down to the nearest standard fuse size.

LRA = Locked Rotor Amps

RLA = Rated Load Amps

OFM: Outdoor Fan Motor

IFM : Indoor Fan Motor

FLA = Full Load Amps

Short Circuit Current Rating (SCCR) is 5,000A

FUNCTIONS, CONTROLS, OPTIONS

Table 5: Single-Zone Extended Piping System Functions, Controls, Options Table.

System Type		KSSAP241A	KSSAP301A	KSSAP361A
Airflow	Air Supply Outlet	1	1	1
	Airflow Direction Control (Left/Right)	Five (5) Steps	Five (5) Steps	Five (5) Steps
	Airflow Direction Control (Up/Down)	Six (6) Steps	Six (6) Steps	Six (6) Steps
	Auto Swing (Left / Right)	√	√	√
	Auto Swing (Up / Down)	√	√	√
	Fan Speed Steps (Fan/Cool/Heat)	6 / 6 / 6	6 / 6 / 6	6 / 6 / 6
	Natural Wind (Auto Wind)	√	√	√
	Jet Cool / Heat (Power Wind)	√ / √	√ / √	√ / √
	Auto Fan (Fan Speed Auto)	√	√	√
	Comfort Air	√	√	√
	Filter	Prefilter (Washable) ¹	√	√
Reliability	Hot Start	√	√	√
	Self Diagnosis / Smart Diagnosis	√ / √	√ / √	√ / √
	Defrost/Deicing	√	√	√
	Dry (Dehumidification) Operation	√	√	√
Convenience	Auto Changeover	√	√	√
	Auto Cleaning (Coil Dry)	√	√	√
	Heat Exchanger Cleaning (Upgrade Only Function ²)	√	√	√
	All Cleaning (Upgrade Only Function ²)	√	√	√
	Auto Clean+ (Upgrade Only Function ²)	√	√	√
	Sleep+ (Upgrade Only Function ²)	√	√	√
	Auto Restart	√	√	√
	Child Lock ³	√	√	√
	Forced Operation	√	√	√
	Sleep Mode	√ 12 Hour	√ 12 Hour	√ 12 Hour
	Timer 24 Hour (On/Off) / 7 Hour (Off) ³	√ / -	√ / -	√ / -
	Timer (Weekly) ³	√	√	√
	Two Thermistor Control ³	√	√	√
	Low Ambient Operation	√	√	√
	Overheating Protection	√	√	√
	Low Heating	√	√	√
	Smart Care	√	√	√
	Night Mode	√	√	√
	Indoor Unit Display Type	Number Display	Number Display	Number Display
	Indoor Unit Display Light	On / Off	On / Off	On / Off
Energy Control	Active Energy Control	Active Energy Control	Active Energy Control	
kW Manager (Upgrade Only Function ³)	√	√	√	

√: Standard Feature

O: Unit Option

X: Not Available

¹Primary washable filter.

²Functions available after upgrading using ThinQ App.

³Requires wired zone controller.

Not all controllers can support all features. Contact your LG representative for details.

FUNCTIONS, CONTROLS, OPTIONS

Table 6: Single-Zone Extended Piping System Functions, Controls, Options Table, continued

System Type		KSSAP241A	KSSAP301A	KSSAP361A
Remote Controllers	Program Controllers (MultiSITE CRC)	○ (PREMTBVC2/C3/C4)	○ (PREMTBVC2/C3/C4)	○ (PREMTBVC2/C3/C4)
	Standard III Remote Controllers	○ (PREMTB101/BB11)	○ (PREMTB101/BB11)	○ (PREMTB101/BB11)
	Deluxe Remote Controller	○ (PREMTA201)	○ (PREMTA201)	○ (PREMTA201)
	Wireless Handheld Remote Controller	√ AKB76044208	√ AKB76044208	√ AKB76044208
Central Controllers / Integration Solutions	Network Solution (LGAP)	√	√	√
	Dry Contact	○ (PDRYCB100/PDRYCB300/PDRYCB320/PDRYCB400)		
	AC Smart 5	○ (PACS5A000)	○ (PACS5A000)	○ (PACS5A000)
	ACP 5	○ (PACP5A000)	○ (PACP5A000)	○ (PACP5A000)
	PI-485	○ PMNFP14A1	○ PMNFP14A1	○ PMNFP14A1
	MultiSITE Communication Manager	○ (PBACNBTR0A)	○ (PBACNBTR0A)	○ (PBACNBTR0A)
	ACP 5 BACnet® Gateway	○ (PACP5A000)	○ (PACP5A000)	○ (PACP5A000)
	LonWorks® Gateway	○ (ZHWLONWK0)	○ (ZHWLONWK0)	○ (ZHWLONWK0)
Special Functions	Wi-fi ¹	○ Embedded	○ Embedded	○ Embedded
	Wind Baffle Kit	○ (ZLABGP04A)	○ (ZLABGP04A)	○ (ZLABGP04A)
	Sump Heater	√	√	√
	Crank Case Heater	√	√	√
Other	Mode Lock	√ Cooling Only or Heating Only		
	Temperature Control	Thermistor	Thermistor	Thermistor

√: Standard Feature
 ○: Unit Option
 X: Not Available

¹If shown as "Embedded", this function is included in product. The function Wi-Fi is only compatible with 2.4 GHz band. (802.11 b/g/n). When Dry Contact Mode active, Wi-Fi Function can not be used. When changing from Wi-Fi mode to dry contact mode, normal operation resumes in approximately 3 minutes.
 Not all controllers can support all features. Contact your LG representative for details.

ACCESSORIES

LG Monitoring View (LGMV) Diagnostic Software and Cable

LG Monitoring View (LGMV) is a maintenance and troubleshooting tool for Multi V™ air conditioning systems. LGMV formats are available for computer or mobile phone use.

The main screen for LGMV allows the user to view the following real time data:

- Actual inverter compressor speed
- Target inverter compressor speed
- Actual outdoor fan speed
- Target outdoor unit fan speed
- Actual superheat
- Target superheat
- Actual subcooler circuit superheat
- Target subcooler circuit superheat
- Main EEV position
- Subcooling EEV position
- Inverter compressor current transducer value
- Outdoor air temperature
- Actual high pressure/saturation temperature
- Actual low pressure/saturation temperature
- Suction temperature
- Inverter compressor discharge temperature
- Constant speed compressor discharge temperature
- Front outdoor coil pipe temperature
- Back outdoor coil pipe temperature
- Liquid line pipe temperature
- Subcooler inlet temperature
- Subcooler outlet temperature
- Average indoor unit (IDU) pipe temperature
- Inverter compressor operation indicator light
- Four-way reversing valve operation indicator light
- Pressure graph showing actual low pressure and actual high pressure levels
- Error code display
- Operating mode indicator
- Target high pressure
- Target low pressure
- PCB (printed circuit board) version
- Software version
- Installer name
- Model no. of outdoor units
- Site name
- Total number of connected indoor units
- Communication indicator lights
- Indoor unit capacity
- Indoor unit operating mode
- Indoor unit fan speed
- Indoor unit EEV position
- Indoor unit room temperature
- Indoor unit inlet pipe temperature
- Indoor unit outlet pipe temperature
- Indoor unit error code

Additional screens can be accessed by tabs on the main screen

1. Cycleview: Graphic of internal components including

- Compressors showing actual speeds
- EEVs
- Indoor Units
- Liquid injection valves
- Temperature and pressure sensors
- Four-way reversing valve
- Outdoor fans showing status and speeds

2. Graph:

Full screen graph of actual high and low pressures and high and low pressure limits. A sliding bar enables user to go back in time and view data.

3. Control IDU: Enables user to turn on all IDUs default setpoints of 86°F in heat mode or 64°F in cool mode.

4. Setting: Converts metric values to imperial values.

5. Making Data: Recording of real time data to a separate file created to be stored on the user's computer.

6. Loading Data: Recorded data from a saved ".CSV" file can be loaded to create an LGMV session.

7. Electrical Data: Screen is changed to show the following:

- Inverter compressor
 - Amps / Volts / Power Hz
 - Inverter control board fan Hz
- Constant compressor
 - Current transducer value
 - Phase

Figure 3: Sample Cycleview (Computer View Example).

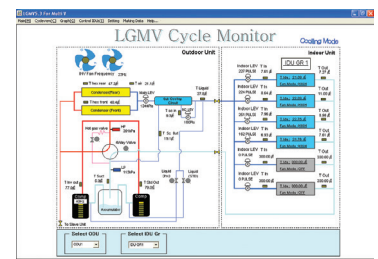

In lieu of connecting to the outdoor unit, user has the option to connect to the indoor unit with a connector kit. When connected through the indoor unit, user will not be able to record data.

This software can be used to both pre-set-up new systems and troubleshoot existing systems. LGMV data can be recorded to a ".CSV" file and emailed to an LG representative to assist with diagnostic evaluations.

LGMV is available in different formats. Contact your LG Sales Representative for system requirements and for more information.

ThinQ

LG ThinQ is a built-in Wi-Fi module, along with a free smart phone app that provides monitoring and remote control capabilities for certain LG single zone systems. The app has the following features and benefits:

- Sign in to the app using LG credentials, or using Google® or Facebook® login credentials. Users only have to log in to the app once; the app remembers login details for subsequent logins.
- View current temperature settings of the air conditioning unit and change temperature, fan speed, and air flow direction from anywhere in the house or at a remote location (through the use of wireless connection). Multiple users can control the household air conditioning unit remotely.
- Monitor filter usage of the unit.
- Set up weekly schedules to start and stop air conditioner activity.
- Set up the unit to run in different Modes, depending on the user's schedule. Set up specific temperatures for when the user is home, away on vacation, or sleeping.
- Troubleshoot problems, and view tips on general maintenance of the system using the Smart Diagnosis function.

**Google is a registered trademark of Google Inc.; Facebook is a registered trademark of Facebook.*

Contact your LG Sales Representative or visit www.lghvac.com for system requirements, how to download the app, a user's manual, or other information.

Figure 4: Example of an LG Smart ThinQ Screen (appearances may differ depending on version of software).

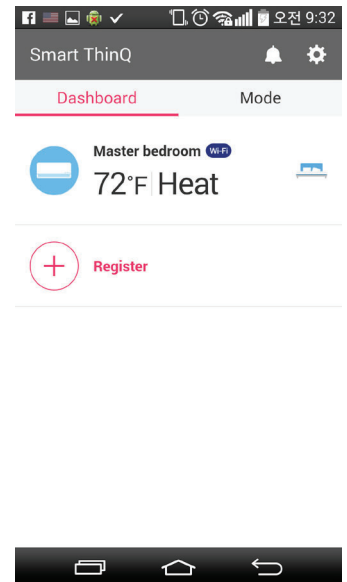

OUTDOOR UNIT DIMENSIONS

KUSAP241A, KUSAP301A, KUSAP361A

Figure 5: KUSAP241A, KUSAP301A, KUSAP361A Outdoor Unit Dimensions.

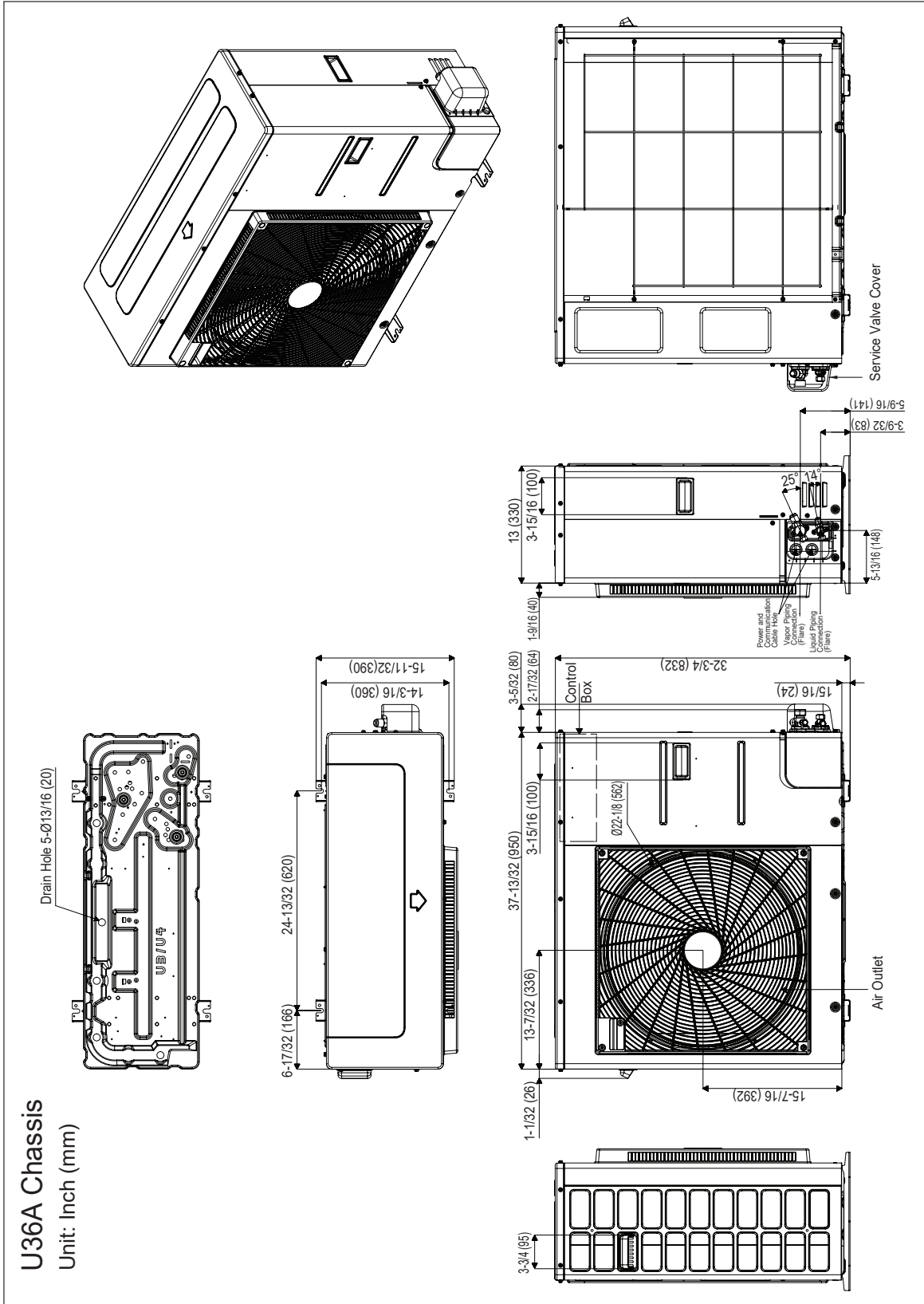

OUTDOOR UNIT CENTER OF GRAVITY / CORNER WEIGHT

Figure 6: Center of Gravity and Corner Weight Dimensions Diagram.

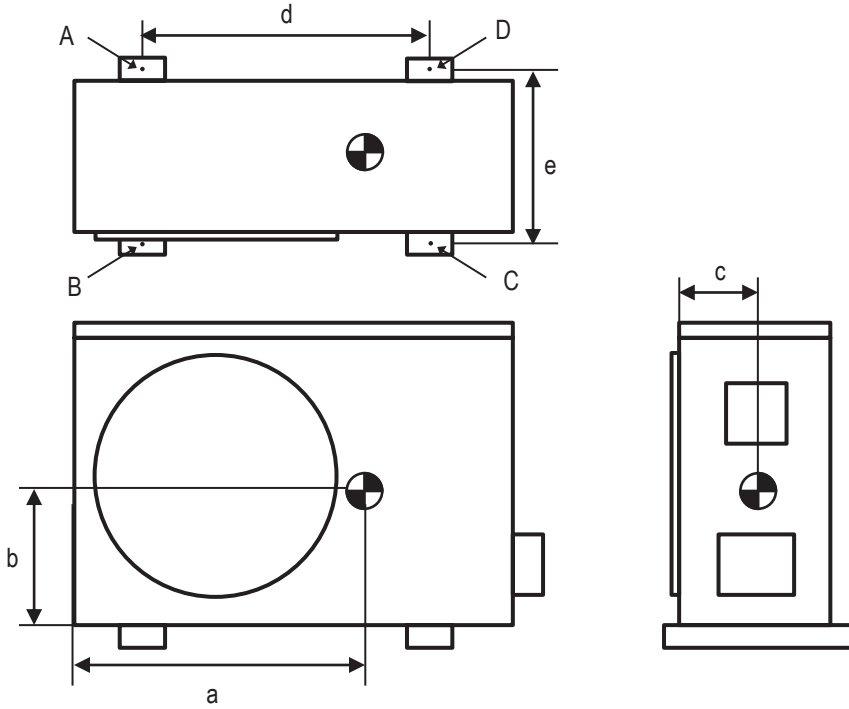

Table 7: Center of Gravity and Corner Weight Dimensions.

Model	Weight (lb.)		Center of Gravity (inch)			Leg (inch)		Corner Weight (lb.)			
	Shipping	Net	a	b	c	d	e	A	B	C	D
KUSAP241A	147.7	135.4	23-7/32	12-19/32	5-29/32	24-13/32	14-13/32	18.6	24.2	49.1	43.5
KUSAP301A, KUSAP361A	160.3	147.9	23-7/32	12-19/32	5-29/32	24-13/32	14-13/32	20.3	26.5	53.7	47.4

Product Data

INDOOR UNIT DIMENSIONS

KNSAP301A, KNSAP361A

Figure 8: KNSAP301A and KNSAP361A Indoor Unit Dimensions.

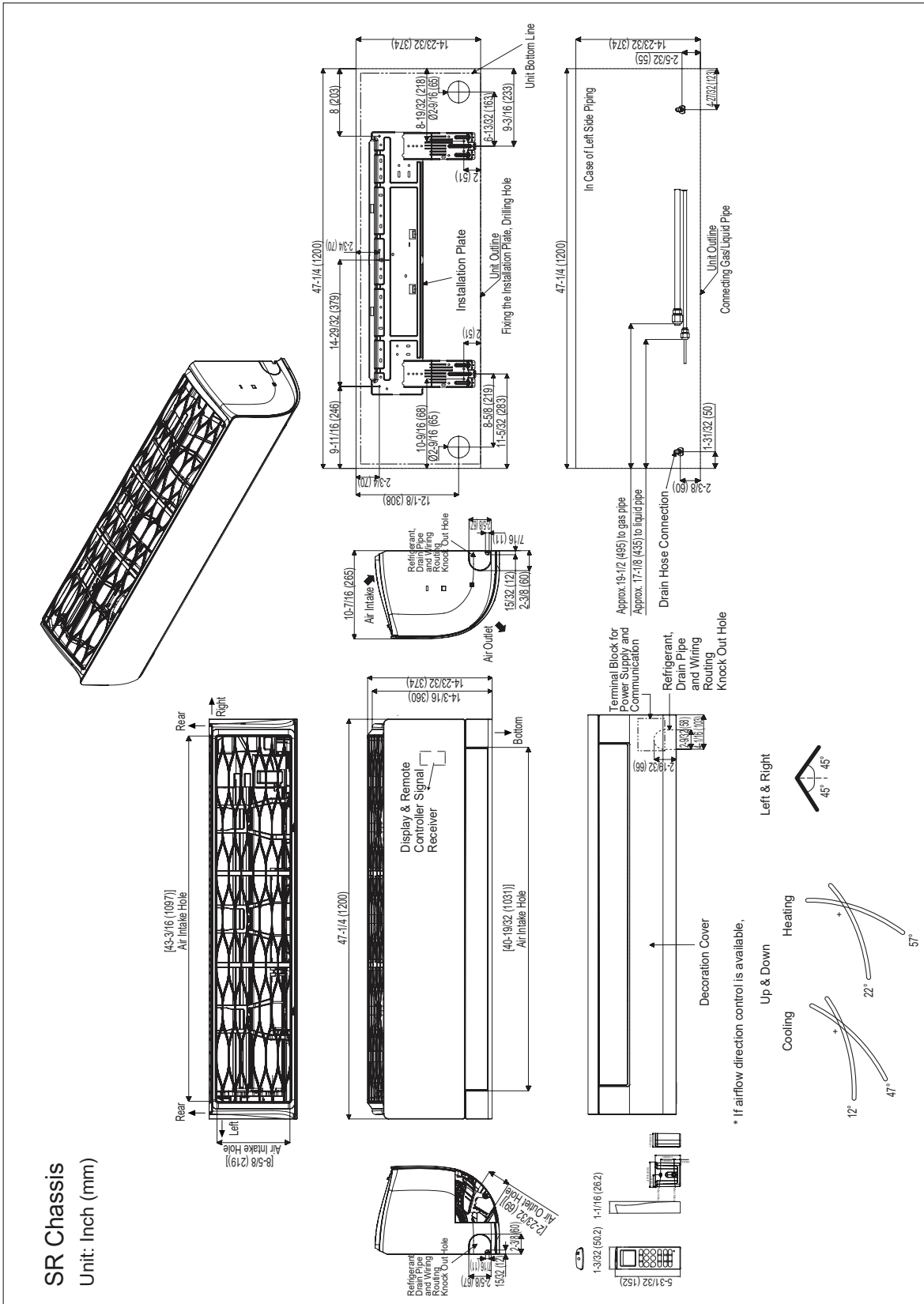

Product Data

AIR FLOW

Indoor Unit Air Flow / Temperature Distribution

Figure 9: KNSAP241A Air Velocity and Temperature Distribution Charts.

Cooling

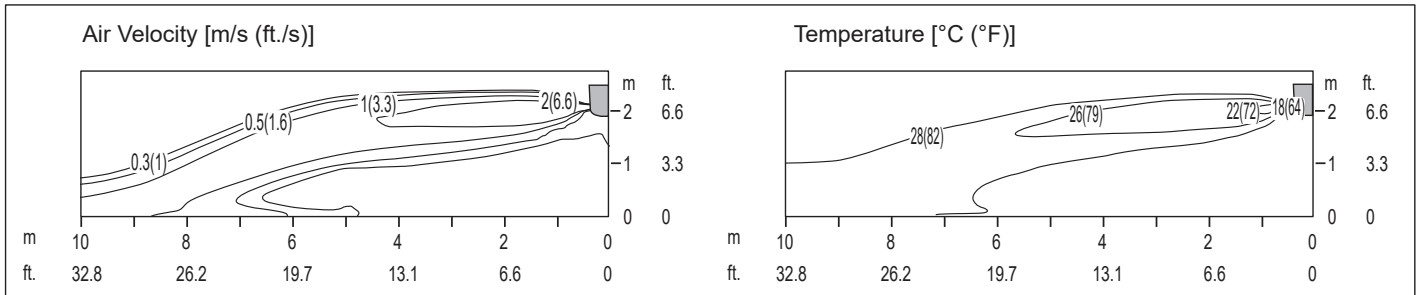

Side View

Discharge Angle : 22° (From the floor)

Vertical Louver : Center

Fan Speed : Power

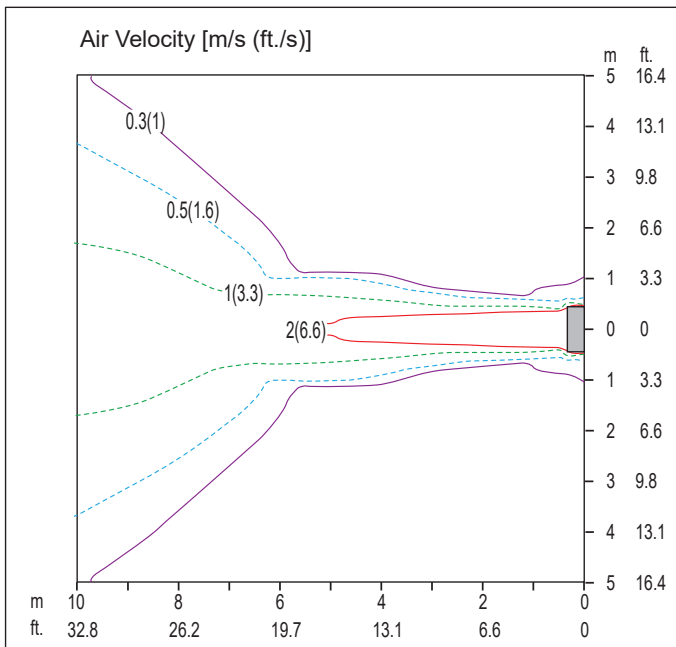

Top View

Discharge Angle : 22° (From the floor)

Vertical Louver : Center

Fan Speed : Power

Air Speed 0.3 m/s (1 ft./s) Range : 20.0 m (65.6 ft.)

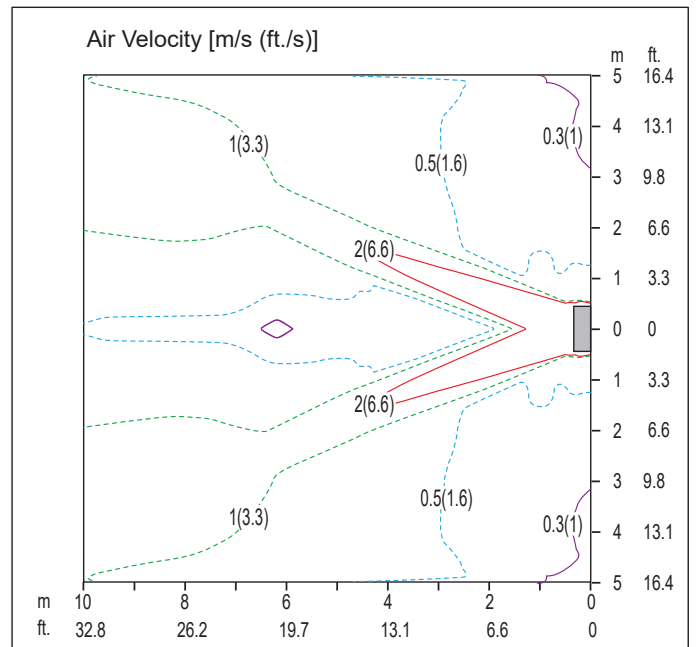

Top View

Discharge Angle : 22° (From the floor)

Vertical Louver : Left & Right

Fan Speed : Power

Figure 10: KNSAP241A Air Velocity and Temperature Distribution Charts, continued.

Heating

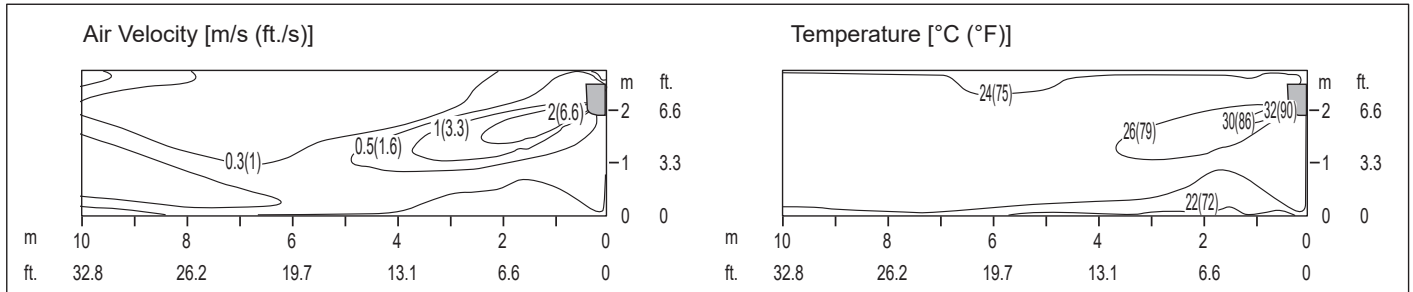

Side View

Discharge Angle : 42° (From the floor)

Vertical Louver : Center

Fan Speed : Power

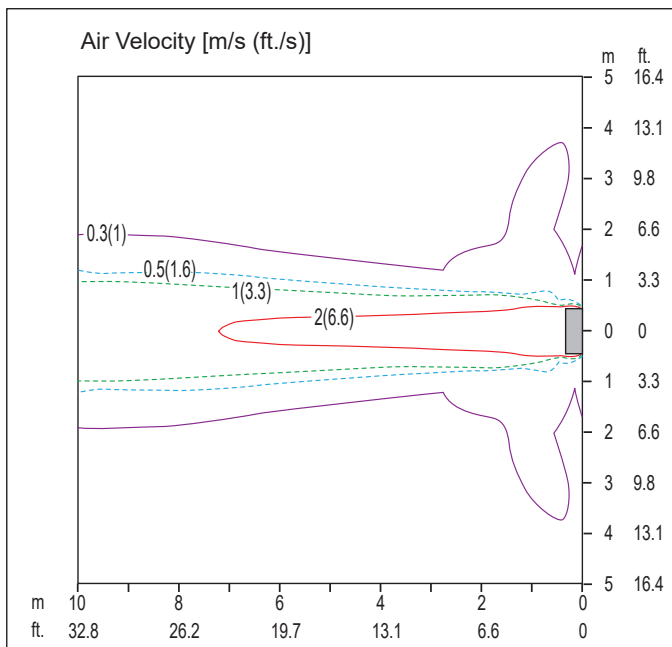

Top View

Discharge Angle : 42° (From the floor)

Vertical Louver : Center

Fan Speed : Power

Air Speed 0.3 m/s (1 ft./s) Range : 20.0 m (65.6 ft.)

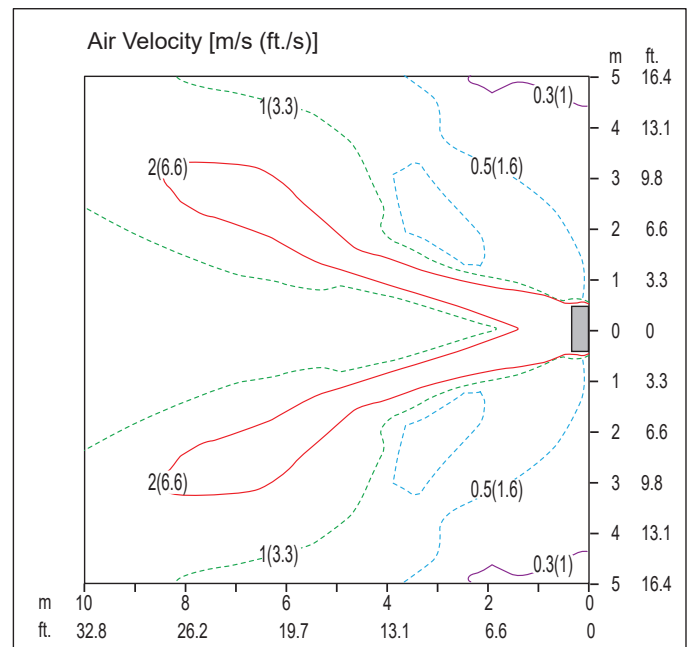

Top View

Discharge Angle : 42° (From the floor)

Vertical Louver : Left & Right

Fan Speed : Power

AIR FLOW

Indoor Unit Air Flow / Temperature Distribution

Figure 11: KNSAP301A Air Velocity and Temperature Distribution Charts.

Cooling

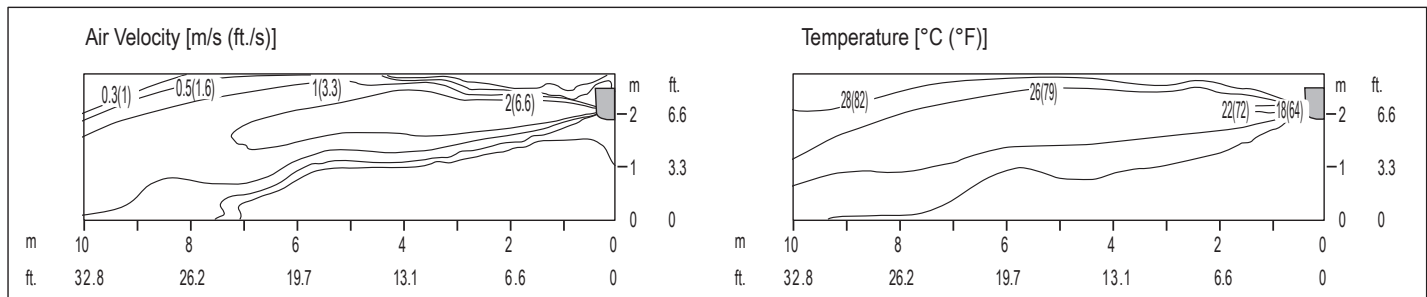

Side View

Discharge Angle : 22° (From the floor ▼)

Vertical Louver : Center

Fan Speed : Power

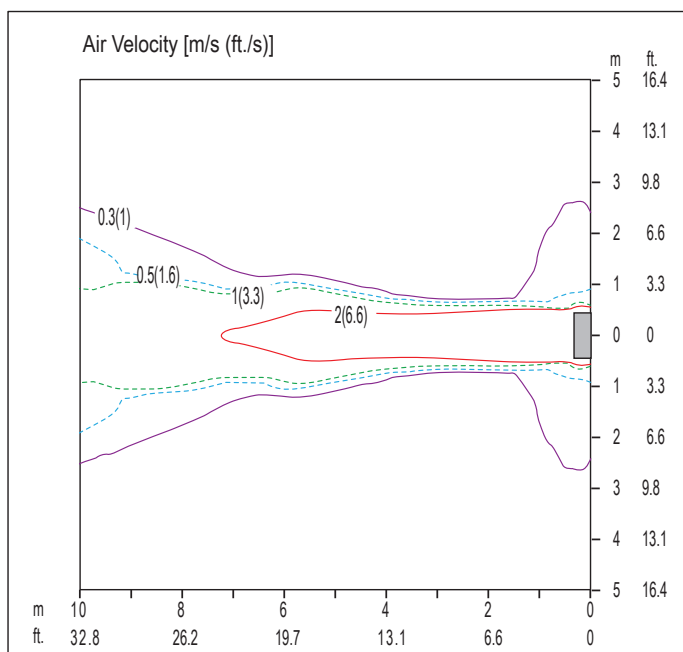

Top View

Discharge Angle : 22° (From the floor ▼)

Vertical Louver : Center

Fan Speed : Power

Air Speed 0.3 m/s (1 ft./s) Range : 20.0 m (65.6 ft.)

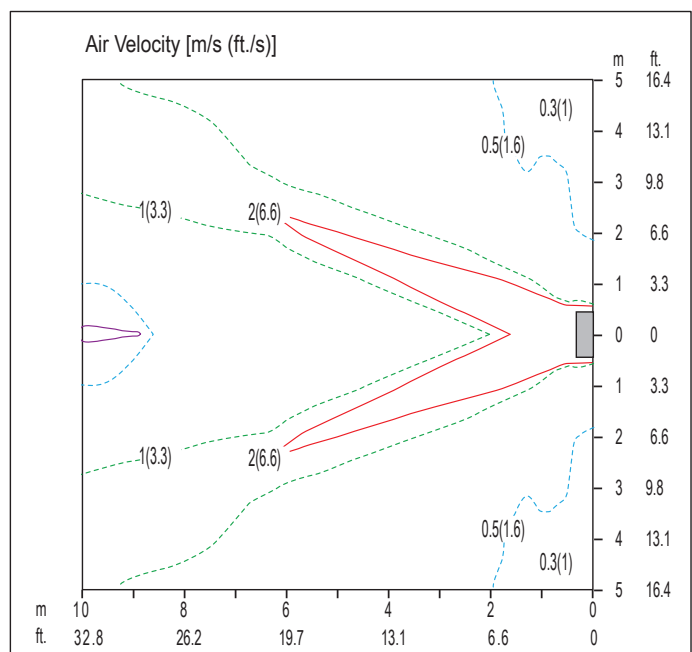

Top View

Discharge Angle : 22° (From the floor ▼)

Vertical Louver : Left & Right

Fan Speed : Power

Figure 12: KNSAP301A Air Velocity and Temperature Distribution Charts, continued.

Heating

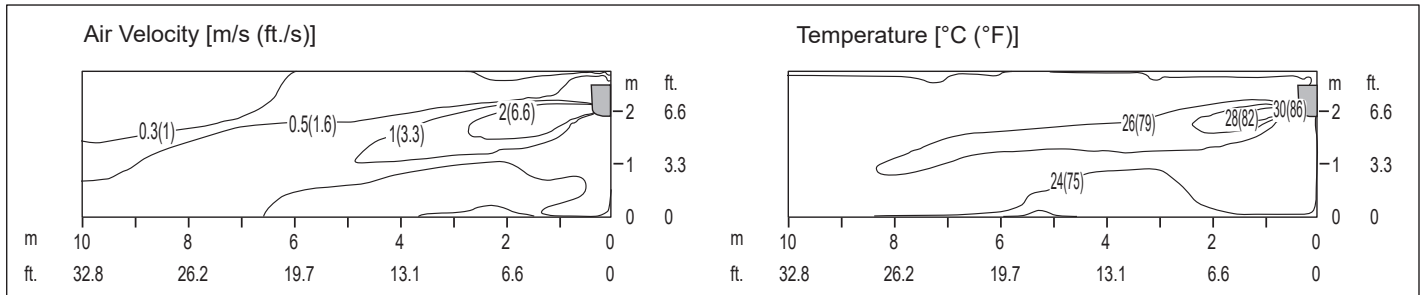

Side View

Discharge Angle : 42° (From the floor ▼)

Vertical Louver : Center

Fan Speed : Power

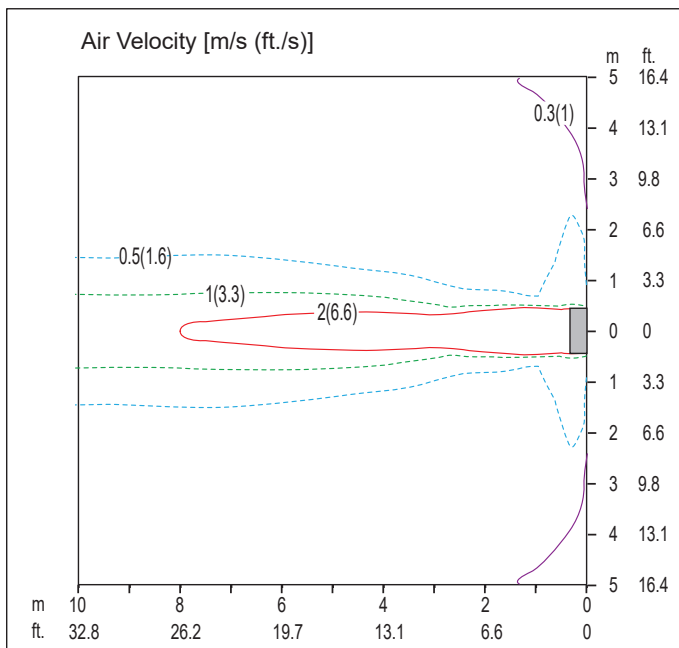

Top View

Discharge Angle : 42° (From the floor ▼)

Vertical Louver : Center

Fan Speed : Power

Air Speed 0.3 m/s (1 ft./s) Range : 20.0 m (65.6 ft.)

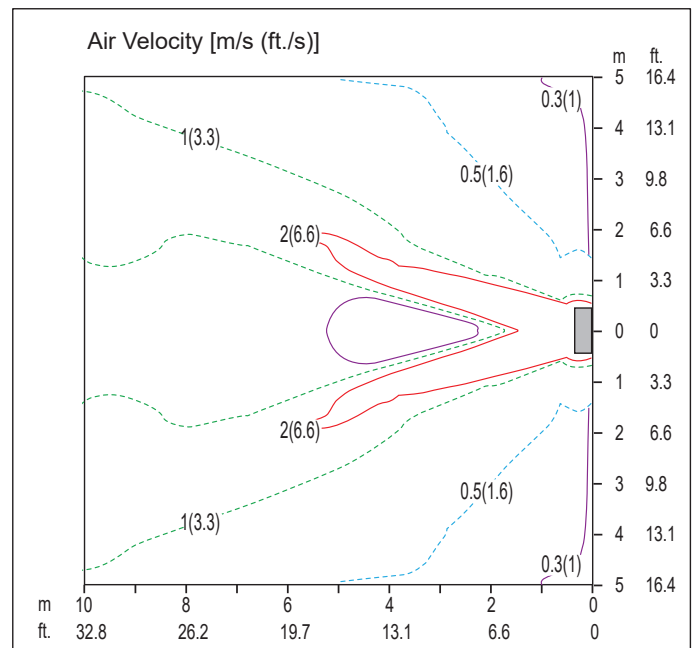

Top View

Discharge Angle : 42° (From the floor ▼)

Vertical Louver : Left & Right

Fan Speed : Power

AIR FLOW

Indoor Unit Air Flow / Temperature Distribution

Figure 13: KNSAP361A Air Velocity and Temperature Distribution Charts.

Cooling

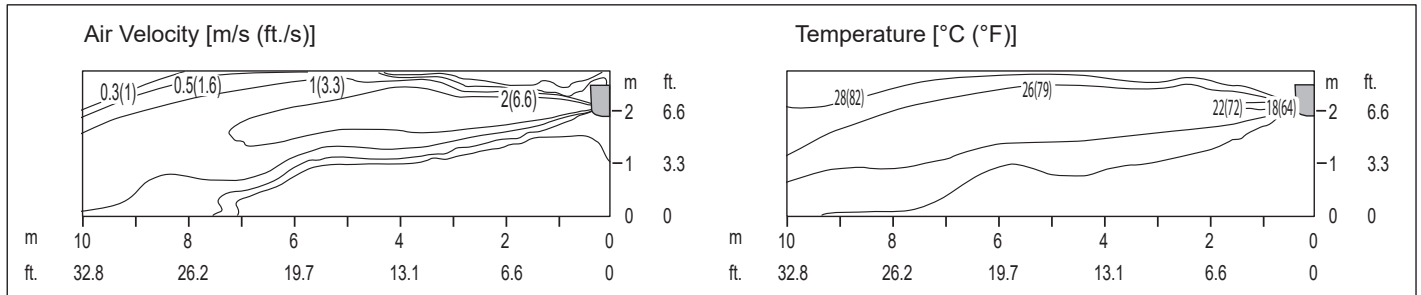

Side View

Discharge Angle : 22° (From the floor ▼)

Vertical Louver : Center

Fan Speed : Power

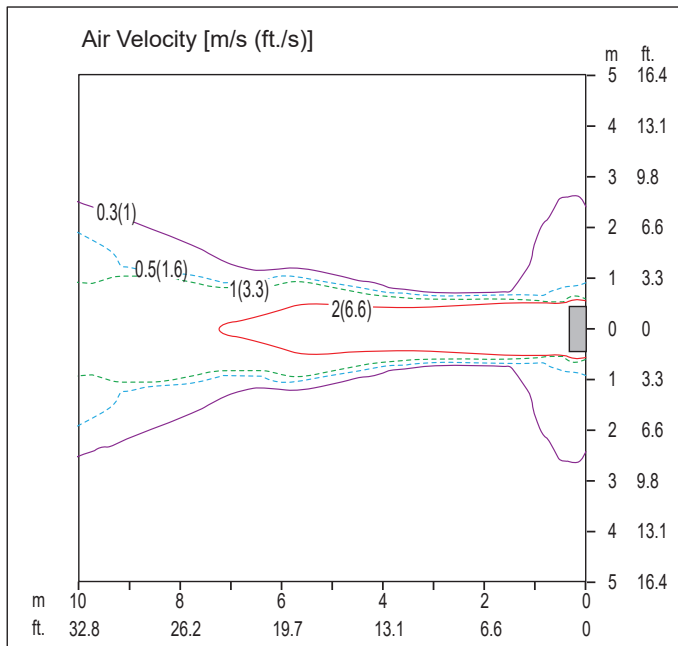

Top View

Discharge Angle : 22° (From the floor ▼)

Vertical Louver : Center

Fan Speed : Power

Air Speed 0.3 m/s (1 ft./s) Range : 20.0 m (65.6 ft.)

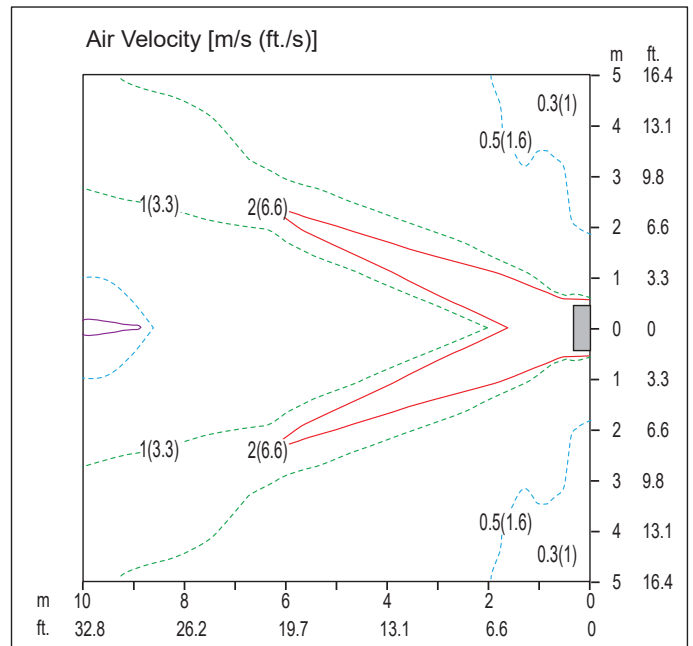

Top View

Discharge Angle : 22° (From the floor ▼)

Vertical Louver : Left & Right

Fan Speed : Power

Figure 14: KNSAP361A Air Velocity and Temperature Distribution Charts, continued.

Heating

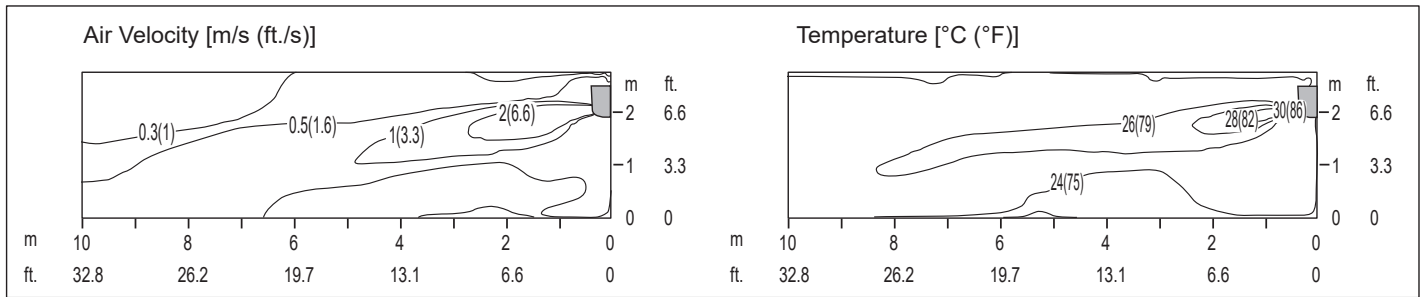

Side View

Discharge Angle : 42° (From the floor ▼)

Vertical Louver : Center

Fan Speed : Power

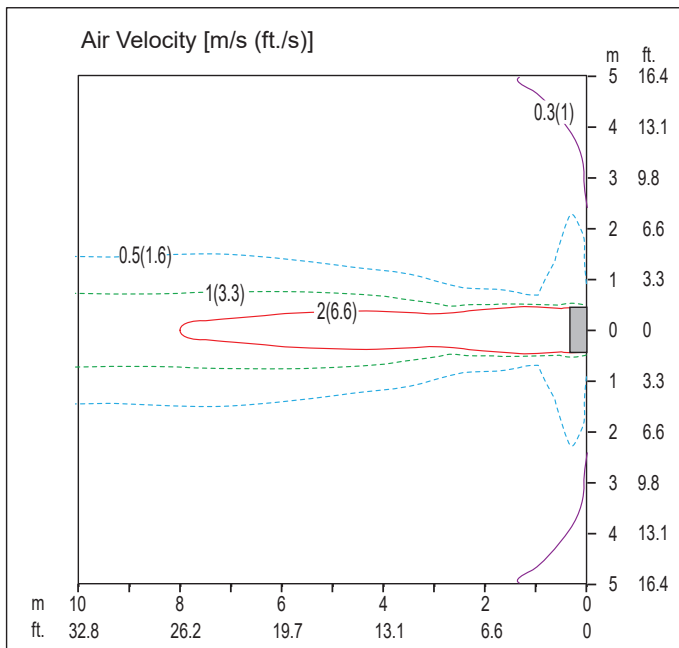

Top View

Discharge Angle : 42° (From the floor ▼)

Vertical Louver : Center

Fan Speed : Power

Air Speed 0.3 m/s (1 ft./s) Range : 20.0 m (65.6 ft.)

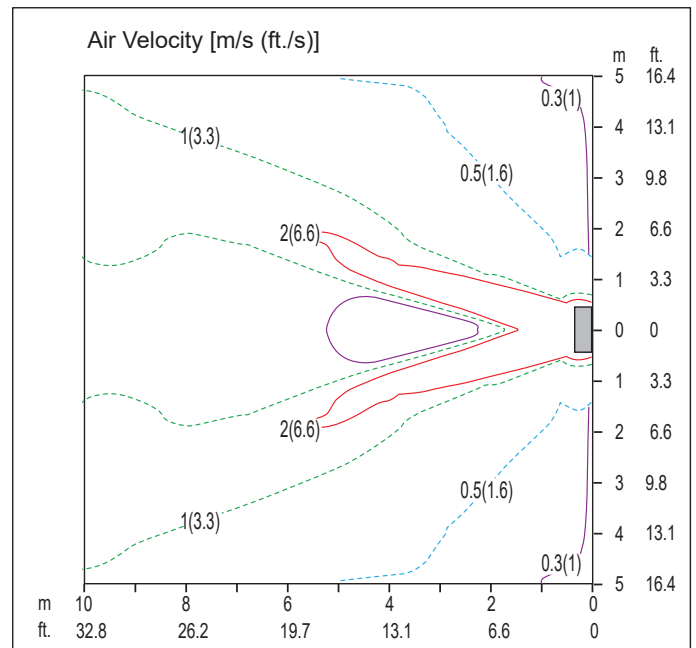

Top View

Discharge Angle : 42° (From the floor ▼)

Vertical Louver : Left & Right

Fan Speed : Power

ACOUSTIC DATA

Sound Pressure for Outdoor Units

Figure 15: Extended Piping Outdoor Unit Sound Pressure Level Measurement Location.

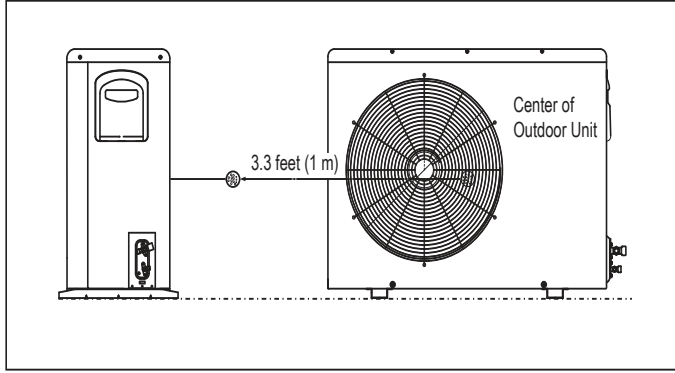

- Measurements are taken 3.3 feet away from the front of the unit.
- Sound pressure levels are measured in dB(A) with a tolerance of ± 1 .
- Data is valid at nominal operation conditions. Operating conditions are assumed to be standard.
- Reference acoustic pressure $0\text{dB}=20\mu\text{Pa}$
- Sound pressure levels are tested in an anechoic chamber under ISO Standard 3745, and may be different according to the test condition or equipment.
- Sound level will vary depending on a range of factors including the construction (acoustic absorption coefficient) of a particular room in which the unit was installed.

Table 8: Extended Piping Outdoor Unit Sound Pressure Levels (dB[A]).

Model Nos.	Sound Pressure Levels (dB[A])	
	Cooling	Heating
KUSAP241A	55	56
KUSAP301A	55	58
KUSAP361A	55	58

Figure 16: Extended Piping Outdoor Unit Sound Pressure Level Diagrams.

KUSAP241A

Cooling

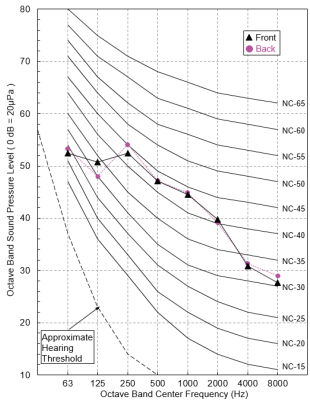

Heating

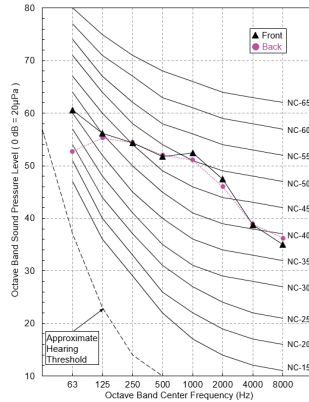

KUSAP301A, KUSAP361A

Cooling

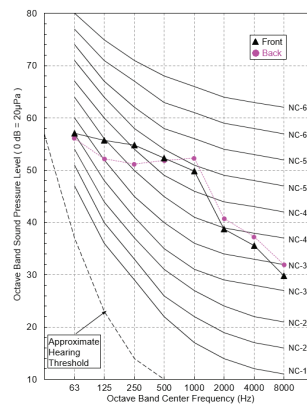

Heating

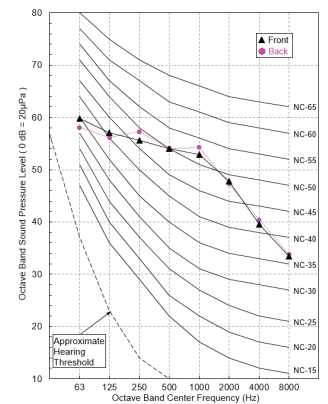

ACOUSTIC DATA

Sound Pressure for Indoor Units

Figure 17: Extended Piping Indoor Unit Sound Pressure Level Measurement Location.

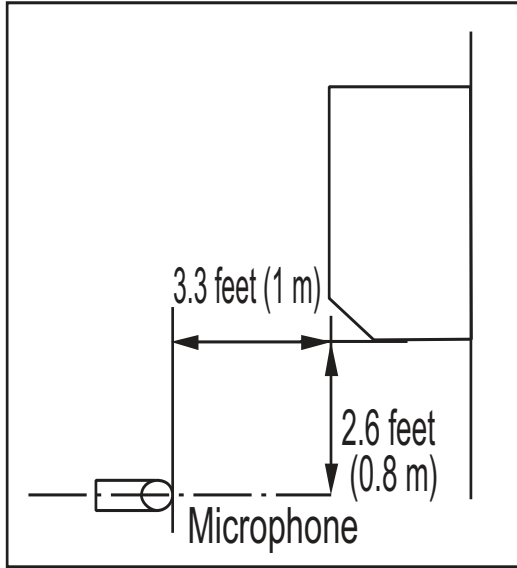

- Measurements are taken 3.3 feet away from the front of the unit.
- Sound pressure levels are measured in dB(A) with a tolerance of ± 1 .
- Data is valid at nominal operation conditions. Operating conditions are assumed to be standard.
- Reference acoustic pressure 0dB=20 μ Pa
- Sound pressure levels are tested in an anechoic chamber under ISO Standard 3745, and may be different according to the test condition or equipment.
- Sound level will vary depending on a range of factors including the construction (acoustic absorption coefficient) of a particular room in which the unit was installed.

Table 9: Extended Piping Indoor Unit Sound Levels (dB[A]).

Model Nos.	Sound Pressure Levels (dB[A])					
	Cooling			Heating		
	H	M	L	H	M	L
KNSAP241A	49	44	40	49	44	40
KNSAP301A	51	47	43	51	47	43
KNSAP361A	51	47	43	51	47	43

Figure 18: Extended Piping Indoor Unit Sound Pressure Level Diagrams.

KNSAP241A
Cooling

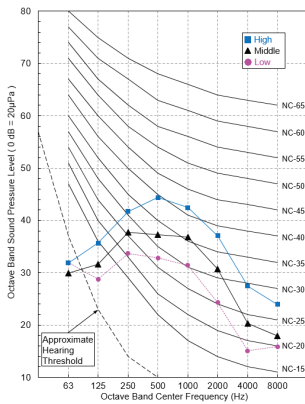

Heating

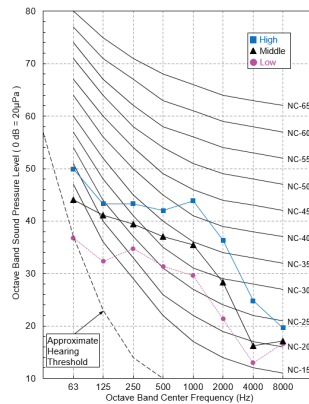

KNSAP301A, KNSAP361A
Cooling

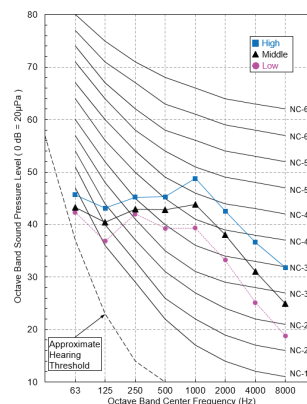

Heating

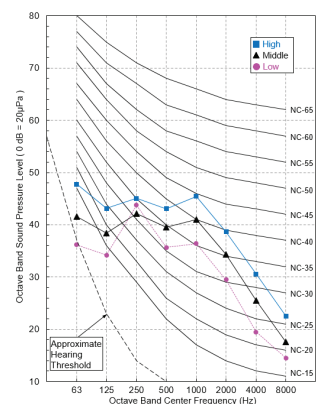

Product Data

PERFORMANCE DATA

Cooling Capacity on page 31

Maximum Cooling Capacity on page 34

Heating Capacity on page 37

Maximum Heating Capacity on page 40

Correction Factors on page 43

Check Selection on page 44

COOLING CAPACITY

KSSAP241A / KNSAP241A - KUSAP241A

Table 10: KSSAP241A / KNSAP241A - KUSAP241A Cooling Capacities.

Outdoor Air Temp. (°F DB)	Indoor Air Temperature (°F DB / °F WB)																				
	64 / 53			68 / 57			72 / 61			77 / 64			80 / 67			86 / 72			90 / 75		
	TC	SHC	PI	TC	SHC	PI	TC	SHC	PI	TC	SHC	PI	TC	SHC	PI	TC	SHC	PI	TC	SHC	PI
0	13.32	10.35	0.66	16.66	11.02	0.78	19.99	11.69	0.90	24.16	12.53	1.05	26.66	13.03	1.14	28.51	18.39	1.20	29.75	21.96	1.24
5	13.07	10.20	0.69	16.34	10.86	0.81	19.61	11.52	0.94	23.70	12.35	1.10	26.15	12.84	1.19	27.97	18.13	1.26	29.18	21.65	1.30
7	13.16	10.29	0.70	16.45	10.96	0.82	19.74	11.63	0.95	23.86	12.46	1.11	26.33	12.96	1.20	28.16	18.30	1.27	29.38	21.85	1.32
10	13.29	10.44	0.71	16.62	11.11	0.84	19.95	11.79	0.97	24.10	12.63	1.13	26.60	13.14	1.22	28.45	18.55	1.29	29.68	22.15	1.34
14	13.39	10.56	0.70	16.74	11.25	0.83	20.10	11.93	0.95	24.29	12.79	1.11	26.80	13.30	1.21	28.66	18.77	1.28	29.90	22.42	1.32
23	14.50	10.91	0.69	17.44	11.61	0.83	20.38	12.32	0.98	24.06	13.20	1.16	26.27	13.73	1.26	28.33	18.15	1.35	29.71	21.10	1.40
25	14.67	11.09	0.71	17.54	11.77	0.85	20.41	12.45	0.99	24.00	13.31	1.17	26.15	13.82	1.28	28.20	18.15	1.36	29.57	21.04	1.42
30	15.10	11.53	0.78	17.79	12.16	0.91	20.48	12.79	1.04	23.84	13.59	1.21	25.85	14.06	1.31	27.88	18.15	1.39	29.23	20.87	1.45
35	15.52	11.97	0.84	18.03	12.55	0.96	20.54	13.14	1.09	23.67	13.86	1.24	25.56	14.30	1.33	27.56	18.14	1.42	28.89	20.70	1.48
40	15.93	12.41	0.91	18.26	12.94	1.02	20.59	13.48	1.14	23.51	14.14	1.28	25.26	14.54	1.36	27.24	18.13	1.45	28.56	20.53	1.51
45	16.33	12.86	0.97	18.49	13.34	1.08	20.65	13.82	1.18	23.34	14.42	1.32	24.96	14.78	1.39	26.92	18.13	1.48	28.22	20.36	1.54
50	16.71	13.30	1.04	18.70	13.73	1.14	20.69	14.16	1.23	23.18	14.69	1.35	24.67	15.02	1.42	26.60	18.12	1.51	27.88	20.19	1.57
55	17.09	13.74	1.11	18.91	14.12	1.20	20.73	14.50	1.28	23.01	14.97	1.39	24.37	15.25	1.45	26.27	18.11	1.55	27.54	20.01	1.61
60	17.45	14.19	1.18	19.11	14.51	1.26	20.76	14.84	1.33	22.83	15.25	1.43	24.07	15.49	1.48	25.95	18.10	1.58	27.21	19.84	1.64
65	17.44	14.14	1.23	19.03	14.54	1.30	20.61	14.94	1.37	22.59	15.43	1.46	23.78	15.73	1.51	25.67	18.21	1.60	26.94	19.87	1.66
70	17.44	14.09	1.28	18.95	14.56	1.34	20.46	15.03	1.41	22.35	15.62	1.49	23.48	15.97	1.54	25.39	18.32	1.63	26.66	19.89	1.69
75	17.43	14.03	1.32	18.87	14.58	1.38	20.31	15.12	1.45	22.11	15.80	1.53	23.19	16.21	1.57	25.11	18.43	1.66	26.39	19.92	1.71
80	17.44	13.98	1.37	18.80	14.59	1.43	20.16	15.21	1.48	21.87	15.98	1.56	22.89	16.45	1.60	24.83	18.54	1.68	26.13	19.94	1.74
85	17.44	13.92	1.41	18.73	14.61	1.47	20.02	15.30	1.52	21.63	16.16	1.59	22.59	16.68	1.63	24.55	18.65	1.71	25.86	19.96	1.77
90	17.45	13.85	1.46	18.66	14.62	1.51	19.87	15.39	1.56	21.39	16.35	1.62	22.30	16.92	1.66	24.27	18.75	1.74	25.59	19.97	1.79
95	17.47	13.79	1.50	18.60	14.63	1.55	19.74	15.47	1.60	21.15	16.53	1.66	22.00	17.16	1.69	24.00	18.85	1.77	25.33	19.98	1.82
100	16.93	13.35	1.52	18.08	14.22	1.57	19.24	15.10	1.62	20.68	16.19	1.68	21.55	16.85	1.71	23.47	18.44	1.79	24.75	19.50	1.84
105	16.39	12.90	1.54	17.56	13.81	1.59	18.74	14.72	1.64	20.21	15.86	1.70	21.10	16.54	1.73	22.93	18.03	1.81	24.16	19.02	1.86
110	15.85	12.47	1.56	17.05	13.41	1.61	18.25	14.35	1.66	19.74	15.53	1.72	20.64	16.24	1.76	22.40	17.62	1.83	23.58	18.55	1.88
115	15.49	12.20	1.58	16.66	13.14	1.63	17.84	14.07	1.68	19.31	15.23	1.74	20.19	15.93	1.78	21.93	17.29	1.86	23.09	18.19	1.91
118	15.27	12.05	1.59	16.43	12.97	1.64	17.60	13.90	1.69	19.05	15.05	1.75	19.92	15.74	1.79	21.65	17.09	1.87	22.80	17.98	1.92
122	14.72	12.22	1.61	15.84	13.15	1.66	16.97	14.09	1.71	18.37	15.26	1.78	19.21	15.96	1.82	20.87	17.33	1.90	21.98	18.23	1.95

Performance Data

DB: Dry Bulb Temperature (°F) WB: Wet Bulb Temperature (°F) TC: Total Capacity (kBtu/h)
 SHC: Sensible Capacity (kBtu/h) PI: Power Input (kW) (includes compressor, indoor fan motor and outdoor fan motor)

Capacity as rated: 0 ft. above sea level with 24.6 ft. of refrigerant piping. 0 ft. level difference between outdoor and indoor units.

Cooling capacity rating obtained with air entering the indoor unit at 80°F dry bulb (DB) and 67°F wet bulb (WB), and outdoor ambient conditions of 95°F dry bulb (DB) and 75°F wet bulb (WB).

- All capacities are net, evaporator fan motor heat is deducted.
- Cooling range can be extended from 14°F down to 0°F using the Low Ambient Wind Baffle Kit (sold separately).
- Grey shading indicates reference data. Operation outside of the verified temperature range is subject to decreased performance and / or safety interruption.
- Direct interpolation is permissible. ⚠ Do not extrapolate.



COOLING CAPACITY

KSSAP301A / KNSAP301A - KUSAP301A

Table 11: KSSAP301A / KNSAP301A - KUSAP301A Cooling Capacities.

Outdoor Air Temp. (°F DB)	Indoor Air Temperature (°F DB / °F WB)																				
	64 / 53			68 / 57			72 / 61			77 / 64			80 / 67			86 / 72			90 / 75		
	TC	SHC	PI	TC	SHC	PI	TC	SHC	PI	TC	SHC	PI	TC	SHC	PI	TC	SHC	PI	TC	SHC	PI
0	18.16	14.11	1.03	22.71	15.02	1.22	27.26	15.94	1.41	32.94	17.08	1.65	36.35	17.77	1.79	38.88	25.08	1.89	40.56	29.95	1.95
5	17.82	13.91	1.08	22.28	14.81	1.28	26.74	15.71	1.47	32.31	16.84	1.72	35.66	17.52	1.87	38.14	24.72	1.97	39.79	29.53	2.04
7	17.94	14.04	1.09	22.43	14.95	1.29	26.92	15.86	1.49	32.54	16.99	1.74	35.90	17.68	1.89	38.40	24.95	1.99	40.06	29.80	2.06
10	18.12	14.23	1.11	22.66	15.15	1.31	27.20	16.07	1.51	32.87	17.23	1.77	36.27	17.92	1.92	38.79	25.29	2.03	40.47	30.21	2.10
14	18.39	15.17	1.13	22.99	16.16	1.33	27.59	17.14	1.54	33.35	18.37	1.80	36.80	19.11	1.95	39.36	26.97	2.06	41.06	32.21	2.13
23	19.89	15.56	1.10	23.93	16.57	1.33	27.97	17.57	1.57	33.02	18.83	1.85	36.04	19.58	2.03	38.88	25.90	2.16	40.76	30.11	2.25
25	20.13	15.79	1.14	24.07	16.76	1.37	28.00	17.74	1.59	32.92	18.96	1.88	35.88	19.69	2.05	38.69	25.85	2.18	40.57	29.96	2.27
30	20.71	16.36	1.24	24.40	17.26	1.45	28.08	18.16	1.67	32.69	19.28	1.93	35.46	19.96	2.09	38.24	25.75	2.23	40.09	29.61	2.32
35	21.28	16.92	1.34	24.72	17.75	1.54	28.16	18.57	1.74	32.46	19.60	1.98	35.04	20.22	2.13	37.78	25.65	2.27	39.62	29.27	2.36
40	21.83	17.49	1.45	25.03	18.24	1.63	28.22	18.99	1.81	32.22	19.92	2.04	34.62	20.49	2.18	37.33	25.55	2.32	39.14	28.93	2.41
45	22.37	18.05	1.55	25.32	18.73	1.72	28.28	19.40	1.89	31.98	20.24	2.09	34.20	20.75	2.22	36.87	25.45	2.36	38.66	28.59	2.46
50	22.89	18.61	1.66	25.61	19.21	1.81	28.33	19.81	1.96	31.74	20.56	2.15	33.78	21.02	2.26	36.42	25.36	2.41	38.18	28.25	2.50
55	23.39	19.17	1.77	25.88	19.70	1.90	28.37	20.23	2.04	31.49	20.89	2.21	33.36	21.28	2.31	35.97	25.26	2.45	37.70	27.92	2.55
60	23.88	19.73	1.88	26.14	20.19	1.99	28.41	20.64	2.11	31.24	21.21	2.26	32.94	21.55	2.35	35.51	25.17	2.50	37.23	27.59	2.59
65	23.85	19.60	1.95	26.02	20.16	2.06	28.19	20.71	2.17	30.89	21.40	2.31	32.52	21.81	2.39	35.11	25.25	2.54	36.84	27.55	2.63
70	23.84	19.48	2.02	25.90	20.13	2.12	27.97	20.78	2.23	30.55	21.59	2.36	32.10	22.08	2.44	34.71	25.33	2.57	36.45	27.50	2.67
75	23.82	19.34	2.08	25.79	20.09	2.18	27.75	20.84	2.28	30.21	21.78	2.41	31.68	22.34	2.48	34.31	25.41	2.61	36.06	27.45	2.70
80	23.81	19.21	2.15	25.67	20.06	2.25	27.54	20.91	2.34	29.86	21.97	2.45	31.26	22.61	2.52	33.91	25.49	2.65	35.68	27.41	2.74
85	23.81	19.08	2.22	25.57	20.03	2.31	27.32	20.97	2.39	29.52	22.16	2.50	30.84	22.87	2.57	33.52	25.56	2.69	35.30	27.35	2.78
90	23.81	18.94	2.29	25.46	19.99	2.37	27.12	21.04	2.45	29.18	22.35	2.55	30.42	23.14	2.61	33.12	25.64	2.73	34.92	27.30	2.81
95	23.82	18.80	2.35	25.37	19.95	2.43	26.91	21.10	2.50	28.84	22.54	2.60	30.00	23.40	2.65	32.72	25.71	2.77	34.54	27.25	2.85
100	23.06	18.36	2.38	24.63	19.56	2.46	26.20	20.77	2.53	28.17	22.28	2.63	29.35	23.18	2.69	31.96	25.37	2.80	33.70	26.83	2.88
105	22.29	17.91	2.41	23.89	19.18	2.49	25.49	20.44	2.56	27.49	22.02	2.66	28.70	22.97	2.72	31.20	25.03	2.83	32.86	26.41	2.91
110	21.53	17.47	2.44	23.16	18.79	2.51	24.79	20.11	2.59	26.82	21.76	2.69	28.04	22.75	2.75	30.43	24.69	2.87	32.03	25.98	2.94
115	21.01	17.26	2.47	22.61	18.58	2.55	24.20	19.90	2.62	26.20	21.54	2.72	27.39	22.53	2.78	29.75	24.45	2.90	31.32	25.74	2.98
118	20.70	17.14	2.49	22.28	18.46	2.56	23.85	19.77	2.64	25.82	21.42	2.74	27.00	22.40	2.80	29.34	24.31	2.93	30.90	25.59	3.01
122	20.08	16.66	2.53	21.61	17.94	2.61	23.13	19.21	2.69	25.04	20.81	2.79	26.19	21.77	2.85	28.46	23.63	2.98	29.97	24.86	3.06

DB: Dry Bulb Temperature (°F) WB: Wet Bulb Temperature (°F) TC: Total Capacity (kBtu/h)
 SHC: Sensible Capacity (kBtu/h) PI: Power Input (kW) (includes compressor, indoor fan motor and outdoor fan motor)

1. All capacities are net, evaporator fan motor heat is deducted.
2. Cooling range can be extended from 14°F down to 0°F using the Low Ambient Wind Baffle Kit (sold separately).
3. Grey shading indicates reference data. Operation outside of the verified temperature range is subject to decreased performance and / or safety interruption.
4. Direct interpolation is permissible. ⚠ Do not extrapolate.

Capacity as rated: 0 ft. above sea level with 24.6 ft. of refrigerant piping. 0 ft. level difference between outdoor and indoor units.

Cooling capacity rating obtained with air entering the indoor unit at 80°F dry bulb (DB) and 67°F wet bulb (WB), and outdoor ambient conditions of 95°F dry bulb (DB) and 75°F wet bulb (WB).

COOLING CAPACITY

KSSAP361A / KNSAP361A - KUSAP361A

Table 12: KSSAP361A / KNSAP361A - KUSAP361A Cooling Capacities.

Outdoor Air Temp. (°F DB)	Indoor Air Temperature (°F DB / °F WB)																				
	64 / 53			68 / 57			72 / 61			77 / 64			80 / 67			86 / 72			90 / 75		
	TC	SHC	PI	TC	SHC	PI	TC	SHC	PI	TC	SHC	PI	TC	SHC	PI	TC	SHC	PI	TC	SHC	PI
0	19.98	15.52	1.28	24.98	16.53	1.52	29.99	17.53	1.75	36.24	18.79	2.05	39.99	19.54	2.22	42.77	27.59	2.34	44.62	32.95	2.43
5	19.60	15.30	1.34	24.50	16.29	1.59	29.41	17.28	1.83	35.54	18.52	2.14	39.23	19.27	2.33	41.95	27.19	2.45	43.76	32.48	2.54
7	19.73	15.44	1.36	24.67	16.44	1.60	29.61	17.44	1.85	35.79	18.69	2.16	39.50	19.44	2.35	42.24	27.44	2.48	44.07	32.78	2.57
10	19.94	15.65	1.38	24.93	16.67	1.63	29.92	17.68	1.88	36.16	18.95	2.20	39.90	19.71	2.39	42.67	27.82	2.52	44.52	33.23	2.61
14	20.04	15.94	1.38	25.05	16.97	1.64	30.07	18.00	1.89	36.34	19.30	2.21	40.10	20.07	2.40	42.88	28.33	2.53	44.74	33.83	2.62
23	21.70	16.45	1.36	26.10	17.51	1.65	30.50	18.57	1.93	36.01	19.90	2.29	39.31	20.70	2.50	42.40	27.37	2.67	44.46	31.82	2.78
25	21.96	16.71	1.41	26.25	17.74	1.69	30.55	18.78	1.97	35.92	20.07	2.31	39.14	20.84	2.52	42.21	27.36	2.69	44.26	31.71	2.80
30	22.61	17.37	1.53	26.63	18.32	1.79	30.65	19.28	2.06	35.68	20.47	2.38	38.70	21.19	2.58	41.73	27.34	2.75	43.76	31.45	2.86
35	23.24	18.03	1.66	26.99	18.91	1.90	30.75	19.78	2.15	35.44	20.88	2.45	38.26	21.54	2.63	41.26	27.32	2.80	43.26	31.18	2.92
40	23.85	18.69	1.79	27.34	19.49	2.01	30.84	20.29	2.24	35.20	21.29	2.52	37.82	21.89	2.69	40.78	27.30	2.86	42.76	30.91	2.98
45	24.45	19.35	1.92	27.68	20.07	2.12	30.92	20.79	2.33	34.96	21.70	2.59	37.38	22.24	2.74	40.31	27.28	2.92	42.26	30.64	3.04
50	25.03	20.01	2.05	28.01	20.65	2.24	30.99	21.30	2.43	34.71	22.11	2.66	36.94	22.59	2.80	39.83	27.26	2.98	41.76	30.37	3.10
55	25.60	20.67	2.19	28.33	21.24	2.35	31.05	21.80	2.52	34.46	22.51	2.73	36.51	22.94	2.86	39.36	27.23	3.04	41.26	30.10	3.16
60	26.15	21.33	2.32	28.63	21.82	2.47	31.11	22.31	2.62	34.21	22.92	2.80	36.07	23.29	2.91	38.88	27.21	3.09	40.76	29.82	3.21
65	26.14	21.25	2.41	28.51	21.85	2.55	30.88	22.44	2.69	33.85	23.19	2.86	35.63	23.64	2.97	38.47	27.37	3.14	40.36	29.86	3.26
70	26.13	21.16	2.50	28.40	21.87	2.63	30.66	22.58	2.76	33.49	23.46	2.92	35.19	23.99	3.02	38.05	27.53	3.19	39.96	29.89	3.31
75	26.13	21.08	2.59	28.29	21.89	2.71	30.44	22.71	2.83	33.14	23.73	2.99	34.75	24.34	3.08	37.64	27.68	3.24	39.56	29.91	3.35
80	26.14	20.98	2.67	28.18	21.91	2.79	30.23	22.84	2.90	32.78	24.00	3.05	34.31	24.69	3.13	37.23	27.84	3.29	39.17	29.93	3.40
85	26.15	20.89	2.76	28.08	21.93	2.87	30.02	22.96	2.97	32.43	24.26	3.11	33.88	25.04	3.19	36.82	27.99	3.34	38.78	29.95	3.45
90	26.18	20.79	2.84	27.99	21.94	2.94	29.81	23.09	3.04	32.08	24.53	3.17	33.44	25.39	3.24	36.41	28.13	3.40	38.38	29.96	3.50
95	26.21	20.68	2.93	27.90	21.95	3.02	29.60	23.21	3.11	31.73	24.79	3.23	33.00	25.74	3.30	36.00	28.28	3.45	38.00	29.97	3.54
100	25.50	20.00	2.97	27.24	21.31	3.06	28.98	22.63	3.16	31.15	24.27	3.28	32.46	25.25	3.35	35.35	27.64	3.49	37.27	29.22	3.59
105	24.79	19.32	3.01	26.57	20.68	3.11	28.35	22.04	3.20	30.58	23.74	3.32	31.91	24.77	3.40	34.70	26.99	3.54	36.55	28.48	3.64
110	24.08	18.64	3.05	25.91	20.05	3.15	27.73	21.46	3.25	30.00	23.22	3.37	31.37	24.28	3.44	34.04	26.35	3.59	35.83	27.73	3.69
115	23.65	18.23	3.10	25.44	19.62	3.20	27.24	21.01	3.29	29.48	22.75	3.42	30.83	23.79	3.49	33.48	25.82	3.64	35.25	27.17	3.75
118	23.38	17.98	3.12	25.16	19.36	3.22	26.94	20.74	3.32	29.17	22.47	3.45	30.50	23.50	3.52	33.14	25.50	3.68	34.91	26.84	3.78
122	22.09	18.32	3.14	23.77	19.73	3.24	25.45	21.13	3.34	27.55	22.89	3.47	28.81	23.95	3.54	31.31	25.99	3.70	32.97	27.35	3.81

Performance Data

DB: Dry Bulb Temperature (°F) WB: Wet Bulb Temperature (°F) TC: Total Capacity (kBtu/h)
 SHC: Sensible Capacity (kBtu/h) PI: Power Input (kW) (includes compressor, indoor fan motor and outdoor fan motor)

Capacity as rated: 0 ft. above sea level with 24.6 ft. of refrigerant piping. 0 ft. level difference between outdoor and indoor units.

Cooling capacity rating obtained with air entering the indoor unit at 80°F dry bulb (DB) and 67°F wet bulb (WB), and outdoor ambient conditions of 95°F dry bulb (DB) and 75°F wet bulb (WB).

- All capacities are net, evaporator fan motor heat is deducted.
- Cooling range can be extended from 14°F down to 0°F using the Low Ambient Wind Baffle Kit (sold separately).
- Grey shading indicates reference data. Operation outside of the verified temperature range is subject to decreased performance and / or safety interruption.
- Direct interpolation is permissible. ⚠ Do not extrapolate.



MAXIMUM COOLING CAPACITY

KSSAP241A / KNSAP241A - KUSAP241A

Table 13: KSSAP241A / KNSAP241A - KUSAP241A Maximum Cooling Capacities.

Outdoor Air Temp. (°F DB)	Indoor Air Temperature (°F DB / °F WB)																				
	64 / 53			68 / 57			72 / 61			77 / 64			80 / 67			86 / 72			90 / 75		
	TC	SHC	PI	TC	SHC	PI	TC	SHC	PI	TC	SHC	PI	TC	SHC	PI	TC	SHC	PI	TC	SHC	PI
0	18.16	13.93	1.23	22.71	14.83	1.46	27.26	15.73	1.68	32.94	16.86	1.97	36.35	17.54	2.13	38.88	24.76	2.25	40.56	29.57	2.33
5	17.82	13.73	1.29	22.28	14.62	1.52	26.74	15.51	1.76	32.31	16.62	2.06	35.66	17.29	2.23	38.14	24.40	2.36	39.79	29.15	2.44
7	17.94	13.86	1.30	22.43	14.76	1.54	26.92	15.65	1.78	32.54	16.78	2.08	35.90	17.45	2.26	38.40	24.63	2.38	40.06	29.42	2.47
10	18.12	14.05	1.32	22.66	14.96	1.57	27.20	15.87	1.81	32.87	17.01	2.11	36.27	17.69	2.29	38.79	24.97	2.42	40.47	29.82	2.51
14	17.79	13.85	1.28	22.24	14.75	1.52	26.69	15.65	1.75	32.26	16.77	2.04	35.60	17.44	2.22	38.07	24.62	2.34	39.72	29.41	2.42
23	19.30	14.36	1.27	23.22	15.29	1.53	27.14	16.22	1.80	32.04	17.38	2.13	34.98	18.07	2.33	37.73	23.90	2.48	39.56	27.78	2.58
25	19.55	14.60	1.31	23.37	15.51	1.57	27.19	16.41	1.83	31.97	17.54	2.15	34.84	18.21	2.35	37.58	23.91	2.50	39.40	27.71	2.61
30	20.15	15.21	1.43	23.74	16.05	1.68	27.32	16.89	1.92	31.80	17.93	2.22	34.49	18.56	2.41	37.20	23.95	2.57	39.00	27.55	2.67
35	20.74	15.83	1.55	24.09	16.60	1.78	27.44	17.37	2.01	31.63	18.33	2.30	34.15	18.91	2.47	36.83	23.99	2.63	38.61	27.37	2.73
40	21.32	16.44	1.68	24.44	17.15	1.89	27.56	17.85	2.10	31.46	18.73	2.37	33.80	19.26	2.52	36.45	24.02	2.69	38.22	27.20	2.80
45	21.88	17.06	1.81	24.78	17.70	2.00	27.67	18.33	2.19	31.29	19.13	2.44	33.46	19.61	2.58	36.08	24.05	2.75	37.82	27.01	2.86
50	22.44	17.68	1.94	25.10	18.25	2.11	27.77	18.82	2.29	31.11	19.53	2.51	33.11	19.96	2.64	35.70	24.08	2.81	37.43	26.83	2.92
55	22.98	18.30	2.07	25.42	18.80	2.23	27.87	19.30	2.38	30.93	19.93	2.58	32.77	20.31	2.70	35.33	24.11	2.87	37.03	26.64	2.98
60	23.50	18.92	2.20	25.73	19.35	2.34	27.96	19.79	2.48	30.75	20.33	2.66	32.42	20.66	2.76	34.95	24.13	2.93	36.64	26.45	3.05
65	23.53	18.88	2.29	25.66	19.41	2.42	27.80	19.94	2.56	30.47	20.61	2.72	32.07	21.01	2.82	34.63	24.32	2.99	36.33	26.53	3.10
70	23.56	18.84	2.38	25.60	19.47	2.50	27.64	20.10	2.63	30.20	20.88	2.78	31.73	21.35	2.88	34.31	24.50	3.04	36.03	26.60	3.15
75	23.60	18.79	2.47	25.54	19.52	2.58	27.49	20.25	2.70	29.92	21.16	2.85	31.38	21.70	2.94	33.99	24.68	3.09	35.73	26.67	3.20
80	23.64	18.74	2.55	25.49	19.57	2.66	27.34	20.40	2.77	29.65	21.43	2.91	31.04	22.05	2.99	33.67	24.86	3.15	35.43	26.74	3.25
85	23.70	18.69	2.64	25.44	19.62	2.74	27.19	20.54	2.85	29.38	21.71	2.98	30.69	22.40	3.05	33.35	25.04	3.20	35.13	26.79	3.30
90	23.75	18.63	2.73	25.40	19.66	2.82	27.05	20.69	2.92	29.11	21.98	3.04	30.35	22.75	3.11	33.04	25.21	3.26	34.83	26.85	3.35
95	23.82	18.56	2.81	25.37	19.70	2.90	26.91	20.83	2.99	28.84	22.25	3.10	30.00	23.10	3.17	32.72	25.38	3.31	34.54	26.90	3.40
100	22.97	17.87	2.84	24.54	19.05	2.93	26.10	20.22	3.02	28.06	21.69	3.14	29.24	22.57	3.20	31.84	24.70	3.34	33.58	26.12	3.44
105	22.12	17.19	2.87	23.71	18.41	2.96	25.30	19.62	3.05	27.29	21.13	3.17	28.48	22.04	3.24	30.96	24.02	3.38	32.62	25.35	3.47
110	21.28	16.52	2.90	22.89	17.77	2.99	24.50	19.02	3.09	26.51	20.58	3.20	27.72	21.52	3.27	30.08	23.35	3.41	31.66	24.57	3.51
115	20.68	16.08	2.94	22.25	17.31	3.03	23.82	18.53	3.12	25.78	20.07	3.24	26.96	20.99	3.31	29.28	22.78	3.45	30.83	23.97	3.55
118	20.32	15.82	2.96	21.86	17.03	3.05	23.41	18.24	3.14	25.34	19.76	3.26	26.50	20.67	3.33	28.80	22.43	3.48	30.33	23.61	3.58

DB: Dry Bulb Temperature (°F) WB: Wet Bulb Temperature (°F) TC: Total Capacity (kBtu/h)
 SHC: Sensible Capacity (kBtu/h) PI: Power Input (kW) (includes compressor, indoor fan motor and outdoor fan motor)

- All capacities are net, evaporator fan motor heat is deducted.
- Cooling range can be extended from 14°F down to 0°F using the Low Ambient Wind Baffle Kit (sold separately).
- Direct interpolation is permissible. ⚠ Do not extrapolate.

Capacity as rated: 0 ft. above sea level with 24.6 ft. of refrigerant piping. 0 ft. level difference between outdoor and indoor units.

Cooling capacity rating obtained with air entering the indoor unit at 80°F dry bulb (DB) and 67°F wet bulb (WB), and outdoor ambient conditions of 95°F dry bulb (DB) and 75°F wet bulb (WB).

MAXIMUM COOLING CAPACITY

KSSAP301A / KNSAP301A - KUSAP301A

Table 14: KSSAP301A / KNSAP301A - KUSAP301A Maximum Cooling Capacities.

Outdoor Air Temp. (°F DB)	Indoor Air Temperature (°F DB / °F WB)																				
	64 / 53			68 / 57			72 / 61			77 / 64			80 / 67			86 / 72			90 / 75		
	TC	SHC	PI	TC	SHC	PI	TC	SHC	PI	TC	SHC	PI	TC	SHC	PI	TC	SHC	PI	TC	SHC	PI
0	19.37	14.66	1.40	24.23	15.62	1.65	29.08	16.57	1.91	35.14	17.75	2.23	38.78	18.47	2.42	41.47	26.06	2.56	43.27	31.13	2.65
5	19.00	14.46	1.46	23.76	15.39	1.73	28.52	16.33	2.00	34.47	17.50	2.34	38.04	18.20	2.54	40.68	25.69	2.68	42.44	30.69	2.77
7	19.13	14.59	1.48	23.93	15.54	1.75	28.72	16.48	2.02	34.71	17.66	2.36	38.30	18.37	2.56	40.96	25.93	2.71	42.73	30.97	2.80
10	19.33	14.79	1.50	24.17	15.75	1.78	29.01	16.71	2.05	35.06	17.90	2.40	38.69	18.62	2.60	41.38	26.29	2.75	43.17	31.39	2.84
14	19.09	14.56	1.47	23.86	15.51	1.74	28.64	16.45	2.01	34.62	17.63	2.35	38.20	18.34	2.55	40.85	25.88	2.69	42.62	30.91	2.79
23	20.70	15.10	1.45	24.90	16.07	1.75	29.11	17.05	2.06	34.36	18.27	2.44	37.51	19.00	2.67	40.46	25.13	2.84	42.42	29.21	2.96
25	20.96	15.35	1.50	25.06	16.30	1.80	29.16	17.25	2.10	34.28	18.44	2.47	37.36	19.15	2.69	40.29	25.14	2.87	42.25	29.14	2.99
30	21.60	16.00	1.64	25.44	16.88	1.92	29.29	17.76	2.20	34.09	18.86	2.55	36.98	19.52	2.76	39.88	25.19	2.94	41.81	28.97	3.06
35	22.22	16.64	1.78	25.82	17.46	2.04	29.41	18.27	2.30	33.90	19.28	2.63	36.59	19.89	2.82	39.46	25.23	3.01	41.37	28.79	3.13
40	22.84	17.29	1.92	26.18	18.03	2.16	29.52	18.77	2.40	33.70	19.70	2.71	36.21	20.26	2.89	39.05	25.26	3.07	40.94	28.60	3.20
45	23.43	17.94	2.06	26.53	18.61	2.29	29.63	19.28	2.51	33.50	20.12	2.79	35.83	20.63	2.95	38.63	25.30	3.14	40.50	28.42	3.27
50	24.02	18.60	2.21	26.87	19.20	2.41	29.73	19.80	2.61	33.30	20.55	2.87	35.44	21.00	3.02	38.22	25.33	3.21	40.06	28.22	3.34
55	24.59	19.25	2.36	27.20	19.78	2.54	29.82	20.31	2.72	33.10	20.97	2.95	35.06	21.36	3.08	37.80	25.36	3.28	39.63	28.03	3.40
60	25.14	19.91	2.51	27.52	20.36	2.67	29.91	20.82	2.83	32.89	21.39	3.03	34.68	21.73	3.15	37.39	25.39	3.34	39.19	27.83	3.47
65	25.16	19.87	2.61	27.44	20.43	2.76	29.73	20.99	2.91	32.58	21.68	3.10	34.30	22.10	3.21	37.03	25.59	3.40	38.85	27.92	3.53
70	25.18	19.83	2.71	27.37	20.49	2.85	29.55	21.15	2.99	32.28	21.98	3.17	33.91	22.47	3.28	36.67	25.79	3.46	38.51	28.00	3.58
75	25.21	19.78	2.81	27.29	20.55	2.94	29.37	21.31	3.07	31.97	22.27	3.24	33.53	22.84	3.34	36.32	25.98	3.52	38.17	28.07	3.64
80	25.25	19.73	2.90	27.23	20.60	3.03	29.20	21.47	3.16	31.67	22.56	3.31	33.15	23.21	3.41	35.96	26.17	3.58	37.84	28.14	3.70
85	25.30	19.67	3.00	27.16	20.65	3.12	29.03	21.63	3.24	31.36	22.85	3.38	32.77	23.58	3.47	35.61	26.36	3.64	37.50	28.21	3.75
90	25.35	19.61	3.10	27.11	20.69	3.21	28.87	21.78	3.32	31.06	23.14	3.45	32.38	23.95	3.54	35.26	26.54	3.70	37.17	28.27	3.81
95	25.41	19.54	3.19	27.06	20.74	3.29	28.71	21.93	3.40	30.76	23.42	3.52	32.00	24.32	3.60	34.91	26.72	3.76	36.84	28.32	3.87
100	24.59	18.79	3.22	26.27	20.03	3.33	27.95	21.26	3.43	30.05	22.80	3.56	31.30	23.73	3.64	34.09	25.97	3.80	35.95	27.46	3.90
105	23.78	18.05	3.26	25.49	19.32	3.36	27.19	20.59	3.47	29.33	22.18	3.60	30.61	23.14	3.68	33.28	25.22	3.84	35.06	26.60	3.94
110	22.97	17.31	3.29	24.70	18.62	3.40	26.44	19.93	3.51	28.61	21.56	3.64	29.91	22.55	3.72	32.46	24.47	3.87	34.16	25.75	3.98
115	22.41	16.82	3.33	24.11	18.10	3.44	25.81	19.39	3.54	27.94	20.99	3.68	29.22	21.95	3.76	31.73	23.83	3.92	33.41	25.08	4.03
118	22.08	16.53	3.36	23.76	17.80	3.46	25.44	19.06	3.57	27.54	20.65	3.70	28.80	21.60	3.78	31.30	23.44	3.95	32.96	24.67	4.06

Performance Data

DB: Dry Bulb Temperature (°F) WB: Wet Bulb Temperature (°F) TC: Total Capacity (kBtu/h)
 SHC: Sensible Capacity (kBtu/h) PI: Power Input (kW) (includes compressor, indoor fan motor and outdoor fan motor)

1. All capacities are net, evaporator fan motor heat is deducted.
2. Cooling range can be extended from 14°F down to 0°F using the Low Ambient Wind Baffle Kit (sold separately).
3. Direct interpolation is permissible. Ⓞ Do not extrapolate.

Capacity as rated: 0 ft. above sea level with 24.6 ft. of refrigerant piping. 0 ft. level difference between outdoor and indoor units.

Cooling capacity rating obtained with air entering the indoor unit at 80°F dry bulb (DB) and 67°F wet bulb (WB), and outdoor ambient conditions of 95°F dry bulb (DB) and 75°F wet bulb (WB).



MAXIMUM COOLING CAPACITY

KSSAP361A / KNSAP361A - KUSAP361A

Table 15: KSSAP361A / KNSAP361A - KUSAP361A Maximum Cooling Capacities.

Outdoor Air Temp. (°F DB)	Indoor Air Temperature (°F DB / °F WB)																				
	64 / 53			68 / 57			72 / 61			77 / 64			80 / 67			86 / 72			90 / 75		
	TC	SHC	PI	TC	SHC	PI	TC	SHC	PI	TC	SHC	PI	TC	SHC	PI	TC	SHC	PI	TC	SHC	PI
0	20.59	15.79	1.56	25.74	16.81	1.85	30.89	17.83	2.13	37.34	19.11	2.49	41.20	19.88	2.71	44.06	28.06	2.86	45.97	33.51	2.96
5	20.19	15.56	1.63	25.25	16.57	1.93	30.30	17.58	2.23	36.62	18.84	2.61	40.41	19.60	2.83	43.22	27.66	2.99	45.09	33.03	3.09
7	20.33	15.71	1.65	25.42	16.72	1.95	30.51	17.74	2.26	36.87	19.01	2.64	40.69	19.78	2.86	43.52	27.91	3.02	45.40	33.34	3.13
10	20.54	15.92	1.68	25.68	16.95	1.99	30.82	17.98	2.29	37.25	19.27	2.68	41.11	20.05	2.91	43.96	28.30	3.07	45.87	33.79	3.18
14	20.48	15.95	1.64	25.61	16.99	1.95	30.74	18.02	2.25	37.15	19.31	2.62	41.00	20.09	2.85	43.85	28.36	3.01	45.74	33.87	3.11
23	22.20	16.50	1.62	26.70	17.57	1.96	31.21	18.63	2.30	36.84	19.97	2.73	40.22	20.77	2.98	43.38	27.46	3.18	45.49	31.92	3.31
25	22.47	16.77	1.68	26.87	17.81	2.01	31.26	18.84	2.34	36.75	20.14	2.76	40.05	20.92	3.01	43.19	27.47	3.21	45.29	31.83	3.34
30	23.14	17.45	1.83	27.26	18.41	2.14	31.38	19.37	2.46	36.53	20.57	2.85	39.62	21.29	3.08	42.73	27.48	3.28	44.80	31.60	3.42
35	23.80	18.14	1.99	27.65	19.02	2.28	31.49	19.90	2.57	36.30	21.01	2.93	39.19	21.67	3.15	42.26	27.49	3.36	44.31	31.37	3.49
40	24.44	18.82	2.14	28.02	19.63	2.41	31.60	20.43	2.68	36.07	21.44	3.02	38.75	22.04	3.23	41.79	27.49	3.43	43.81	31.13	3.57
45	25.06	19.50	2.30	28.38	20.23	2.55	31.69	20.96	2.80	35.84	21.87	3.11	38.32	22.42	3.30	41.32	27.50	3.51	43.32	30.89	3.65
50	25.67	20.19	2.47	28.73	20.84	2.69	31.78	21.49	2.92	35.60	22.31	3.20	37.89	22.80	3.37	40.85	27.51	3.58	42.83	30.65	3.73
55	26.26	20.88	2.64	29.06	21.45	2.84	31.86	22.03	3.04	35.36	22.74	3.29	37.46	23.17	3.44	40.38	27.51	3.66	42.34	30.40	3.80
60	26.84	21.57	2.81	29.39	22.06	2.98	31.93	22.56	3.16	35.12	23.18	3.38	37.02	23.55	3.51	39.92	27.51	3.73	41.84	30.15	3.88
65	26.84	21.51	2.92	29.28	22.11	3.08	31.72	22.71	3.25	34.76	23.47	3.46	36.59	23.92	3.59	39.51	27.70	3.80	41.45	30.22	3.94
70	26.85	21.44	3.03	29.18	22.15	3.19	31.51	22.87	3.34	34.42	23.76	3.54	36.16	24.30	3.66	39.10	27.88	3.87	41.06	30.27	4.00
75	26.87	21.37	3.14	29.08	22.19	3.29	31.30	23.02	3.43	34.07	24.06	3.62	35.73	24.68	3.73	38.70	28.07	3.93	40.67	30.32	4.07
80	26.89	21.29	3.24	28.99	22.23	3.38	31.09	23.17	3.52	33.72	24.35	3.70	35.30	25.05	3.80	38.29	28.24	4.00	40.29	30.37	4.13
85	26.92	21.21	3.35	28.90	22.27	3.48	30.89	23.32	3.61	33.37	24.64	3.78	34.86	25.43	3.88	37.89	28.42	4.06	39.91	30.41	4.19
90	26.95	21.13	3.46	28.82	22.30	3.58	30.69	23.47	3.70	33.03	24.93	3.86	34.43	25.80	3.95	37.49	28.59	4.13	39.52	30.45	4.25
95	27.00	21.04	3.56	28.75	22.32	3.68	30.50	23.61	3.79	32.69	25.22	3.93	34.00	26.18	4.02	37.09	28.76	4.20	39.15	30.49	4.32
100	26.27	20.33	3.60	28.06	21.67	3.71	29.85	23.00	3.83	32.09	24.67	3.97	33.43	25.68	4.06	36.41	28.10	4.24	38.40	29.71	4.35
105	25.53	19.63	3.63	27.37	21.02	3.75	29.20	22.40	3.86	31.49	24.13	4.01	32.87	25.17	4.10	35.73	27.44	4.27	37.65	28.94	4.39
110	24.80	18.94	3.67	26.68	20.37	3.78	28.55	21.81	3.90	30.90	23.60	4.05	32.30	24.67	4.14	35.06	26.77	4.31	36.90	28.18	4.43
115	24.35	18.52	3.70	26.19	19.93	3.82	28.04	21.34	3.94	30.35	23.11	4.09	31.74	24.17	4.18	34.47	26.23	4.36	36.29	27.60	4.48
118	24.07	18.26	3.73	25.91	19.66	3.85	27.74	21.06	3.96	30.03	22.81	4.11	31.40	23.86	4.20	34.12	25.90	4.39	35.94	27.26	4.51

DB: Dry Bulb Temperature (°F) WB: Wet Bulb Temperature (°F) TC: Total Capacity (kBtu/h)
 SHC: Sensible Capacity (kBtu/h) PI: Power Input (kW) (includes compressor, indoor fan motor and outdoor fan motor)

- All capacities are net, evaporator fan motor heat is deducted.
- Cooling range can be extended from 14°F down to 0°F using the Low Ambient Wind Baffle Kit (sold separately).
- Direct interpolation is permissible. Ⓣ Do not extrapolate.

Capacity as rated: 0 ft. above sea level with 24.6 ft. of refrigerant piping. 0 ft. level difference between outdoor and indoor units.

Cooling capacity rating obtained with air entering the indoor unit at 80°F dry bulb (DB) and 67°F wet bulb (WB), and outdoor ambient conditions of 95°F dry bulb (DB) and 75°F wet bulb (WB).

HEATING CAPACITY

KSSAP241A / KNSAP241A - KUSAP241A

Table 16: KSSAP241A / KNSAP241A - KUSAP241A Heating Capacities.

Outdoor Air Temp.		Indoor Air Temperature (°F DB)													
°F DB	°F WB	60		64		68		70		72		75		86	
		TC	PI	TC	PI	TC	PI	TC	PI	TC	PI	TC	PI	TC	PI
-3	-4	13.13	1.42	12.73	1.41	12.61	1.41	12.48	1.39	12.39	1.39	12.14	1.38	11.85	1.38
0	-1	14.30	1.56	13.86	1.54	13.72	1.54	13.59	1.53	13.48	1.53	13.21	1.51	12.90	1.51
1	0	14.48	1.57	14.04	1.56	13.90	1.56	13.76	1.54	13.65	1.54	13.38	1.53	13.06	1.53
6	5	15.13	1.63	14.67	1.61	14.52	1.61	14.38	1.60	14.27	1.60	13.98	1.58	13.65	1.58
10	9	15.79	1.68	15.31	1.67	15.16	1.67	15.01	1.65	14.89	1.65	14.59	1.63	14.25	1.63
16	14	16.29	1.70	15.80	1.68	15.64	1.68	15.48	1.67	15.36	1.67	15.06	1.65	14.70	1.65
17	15	16.40	1.72	15.90	1.70	15.74	1.70	15.59	1.68	15.47	1.68	15.16	1.67	14.80	1.67
19	17	16.62	1.75	16.12	1.73	15.96	1.73	15.80	1.72	15.68	1.72	15.36	1.70	15.00	1.70
24	23	18.68	1.80	18.11	1.79	17.93	1.79	17.75	1.77	17.62	1.77	17.26	1.75	16.85	1.75
32	30	22.04	1.88	21.37	1.86	21.15	1.86	20.94	1.85	20.78	1.85	20.36	1.83	19.88	1.83
41	38	24.41	1.93	23.67	1.92	23.43	1.92	23.20	1.90	23.02	1.90	22.56	1.88	22.02	1.88
43	40	24.73	1.94	23.98	1.92	23.73	1.92	23.50	1.90	23.32	1.90	22.85	1.88	22.31	1.88
47	43	25.25	1.96	24.49	1.94	24.24	1.94	24.00	1.92	23.82	1.92	23.34	1.90	22.78	1.90
53	50	25.93	2.00	25.14	1.98	24.89	1.98	24.64	1.96	24.45	1.96	23.96	1.94	23.39	1.94
59	53	26.53	2.02	25.72	2.00	25.46	2.00	25.21	1.98	25.02	1.98	24.51	1.96	23.93	1.96
64	57	27.09	2.06	26.27	2.04	26.00	2.04	25.74	2.02	25.55	2.02	25.04	2.00	24.44	2.00
70	61	27.60	2.09	26.77	2.07	26.50	2.07	26.23	2.05	26.03	2.05	25.51	2.03	24.90	2.03
75	65	27.99	2.12	27.14	2.10	26.87	2.10	26.60	2.07	26.40	2.07	25.87	2.05	25.25	2.05

Performance Data

DB: Dry Bulb Temperature (°F) WB: Wet Bulb Temperature (°F) TC: Total Capacity (kBtu/h)

PI: Power Input (kW) (includes compressor, indoor fan motor and outdoor fan motor)

1. All capacities are net, evaporator fan motor heat is deducted.
2. Direct interpolation is permissible. ⊙ Do not extrapolate..

Capacity as rated: 0 ft. above sea level with 24.6 ft. of refrigerant piping. 0 ft. level difference between outdoor and indoor units.

Heating capacity rating obtained with air entering the indoor unit at 70°F dry bulb (DB) and 60°F wet bulb (WB), and outdoor ambient conditions of 47°F dry bulb (DB) and 43°F wet bulb (WB).

HEATING CAPACITY

KSSAP301A / KNSAP301A - KUSAP301A

Table 17: KSSAP301A / KNSAP301A - KUSAP301A Heating Capacities.

Outdoor Air Temp.		Indoor Air Temperature (°F DB)													
°F DB	°F WB	60		64		68		70		72		75		86	
		TC	PI	TC	PI	TC	PI	TC	PI	TC	PI	TC	PI	TC	PI
-3	-4	16.38	1.77	15.88	1.75	15.72	1.75	15.56	1.73	15.44	1.73	15.13	1.71	14.77	1.71
0	-1	17.83	1.94	17.29	1.92	17.11	1.92	16.94	1.90	16.81	1.90	16.47	1.88	16.08	1.88
1	0	18.05	1.96	17.51	1.94	17.33	1.94	17.16	1.92	17.03	1.92	16.68	1.90	16.29	1.90
6	5	18.86	2.03	18.29	2.01	18.11	2.01	17.93	1.99	17.79	1.99	17.43	1.97	17.02	1.97
10	9	19.69	2.09	19.09	2.07	18.90	2.07	18.71	2.05	18.57	2.05	18.20	2.03	17.77	2.03
16	14	20.31	2.11	19.70	2.09	19.50	2.09	19.30	2.07	19.16	2.07	18.77	2.05	18.33	2.05
17	15	20.45	2.14	19.83	2.12	19.63	2.12	19.44	2.09	19.29	2.09	18.90	2.07	18.45	2.07
19	17	20.73	2.18	20.10	2.16	19.90	2.16	19.70	2.14	19.55	2.14	19.16	2.12	18.70	2.12
24	23	23.68	2.33	22.97	2.30	22.73	2.30	22.51	2.28	22.34	2.28	21.89	2.26	21.37	2.26
32	30	28.55	2.57	27.68	2.54	27.40	2.54	27.13	2.52	26.92	2.52	26.38	2.49	25.75	2.49
41	38	32.57	2.62	31.58	2.60	31.26	2.60	30.95	2.57	30.72	2.57	30.10	2.54	29.39	2.54
43	40	33.25	2.60	32.24	2.58	31.92	2.58	31.60	2.55	31.36	2.55	30.73	2.52	30.00	2.52
47	43	34.09	2.64	33.06	2.62	32.72	2.62	32.40	2.59	32.15	2.59	31.51	2.57	30.76	2.57
53	50	34.83	2.79	33.77	2.77	33.43	2.77	33.10	2.74	32.85	2.74	32.19	2.71	31.42	2.71
59	53	35.62	2.83	34.53	2.80	34.19	2.80	33.85	2.78	33.59	2.78	32.91	2.75	32.13	2.75
64	57	36.37	2.89	35.27	2.86	34.91	2.86	34.57	2.83	34.30	2.83	33.61	2.80	32.82	2.80
70	61	37.06	2.93	35.94	2.90	35.57	2.90	35.22	2.87	34.95	2.87	34.25	2.84	33.44	2.84
75	65	37.58	2.97	36.44	2.94	36.07	2.94	35.71	2.91	35.44	2.91	34.73	2.88	33.90	2.88

DB: Dry Bulb Temperature (°F) WB: Wet Bulb Temperature (°F) TC: Total Capacity (kBtu/h)

PI: Power Input (kW) (includes compressor, indoor fan motor and outdoor fan motor)

1. All capacities are net, evaporator fan motor heat is deducted.

2. Direct interpolation is permissible. ⊙ Do not extrapolate..

Capacity as rated: 0 ft. above sea level with 24.6 ft. of refrigerant piping. 0 ft. level difference between outdoor and indoor units.

Heating capacity rating obtained with air entering the indoor unit at 70°F dry bulb (DB) and 60°F wet bulb (WB), and outdoor ambient conditions of 47°F dry bulb (DB) and 43°F wet bulb (WB).

HEATING CAPACITY

KSSAP361A / KNSAP361A - KUSAP361A

Table 18: KSSAP361A / KNSAP361A - KUSAP361A Heating Capacities.

Outdoor Air Temp.		Indoor Air Temperature (°F DB)													
°F DB	°F WB	60		64		68		70		72		75		86	
		TC	PI	TC	PI	TC	PI	TC	PI	TC	PI	TC	PI	TC	PI
-3	-4	17.79	1.99	17.25	1.97	17.07	1.97	16.90	1.95	16.78	1.95	16.44	1.93	16.05	1.93
0	-1	19.36	2.19	18.78	2.17	18.59	2.17	18.40	2.14	18.26	2.14	17.90	2.12	17.47	2.12
1	0	19.61	2.21	19.02	2.19	18.82	2.19	18.64	2.16	18.49	2.16	18.12	2.14	17.69	2.14
6	5	20.49	2.28	19.87	2.26	19.67	2.26	19.47	2.24	19.32	2.24	18.94	2.22	18.49	2.22
10	9	21.39	2.36	20.74	2.34	20.53	2.34	20.33	2.31	20.17	2.31	19.77	2.29	19.30	2.29
16	14	22.07	2.38	21.40	2.36	21.18	2.36	20.97	2.34	20.81	2.34	20.39	2.31	19.91	2.31
17	15	22.22	2.41	21.54	2.38	21.32	2.38	21.11	2.36	20.95	2.36	20.53	2.34	20.04	2.34
19	17	22.52	2.46	21.83	2.43	21.61	2.43	21.40	2.41	21.24	2.41	20.81	2.38	20.31	2.38
24	23	25.86	2.62	25.08	2.60	24.82	2.60	24.58	2.57	24.39	2.57	23.90	2.55	23.33	2.55
32	30	31.38	2.90	30.43	2.88	30.12	2.88	29.82	2.85	29.59	2.85	29.00	2.82	28.31	2.82
41	38	35.50	2.97	34.42	2.94	34.07	2.94	33.73	2.91	33.48	2.91	32.80	2.88	32.02	2.88
43	40	36.10	2.95	35.01	2.92	34.65	2.92	34.31	2.89	34.05	2.89	33.37	2.86	32.57	2.86
47	43	37.04	2.99	35.91	2.96	35.55	2.96	35.20	2.93	34.93	2.93	34.23	2.91	33.41	2.91
53	50	38.16	3.15	37.00	3.12	36.62	3.12	36.26	3.09	35.98	3.09	35.26	3.06	34.42	3.06
59	53	39.05	3.20	37.86	3.17	37.48	3.17	37.11	3.14	36.83	3.14	36.09	3.11	35.23	3.11
64	57	39.88	3.26	38.67	3.23	38.28	3.23	37.90	3.20	37.61	3.20	36.86	3.17	35.98	3.17
70	61	40.64	3.31	39.40	3.28	39.00	3.28	38.62	3.24	38.32	3.24	37.55	3.21	36.66	3.21
75	65	41.20	3.36	39.95	3.32	39.55	3.32	39.16	3.29	38.86	3.29	38.08	3.26	37.17	3.26

Performance Data

DB: Dry Bulb Temperature (°F) WB: Wet Bulb Temperature (°F) TC: Total Capacity (kBtu/h)

PI: Power Input (kW) (includes compressor, indoor fan motor and outdoor fan motor)

1. All capacities are net, evaporator fan motor heat is deducted.
2. Direct interpolation is permissible. ☹ Do not extrapolate..

Capacity as rated: 0 ft. above sea level with 24.6 ft. of refrigerant piping. 0 ft. level difference between outdoor and indoor units.

Heating capacity rating obtained with air entering the indoor unit at 70°F dry bulb (DB) and 60°F wet bulb (WB), and outdoor ambient conditions of 47°F dry bulb (DB) and 43°F wet bulb (WB).

MAXIMUM HEATING CAPACITY

KSSAP241A / KNSAP241A - KUSAP241A

Table 19: KSSAP241A / KNSAP241A - KUSAP241A Maximum Heating Capacities.

Outdoor Air Temp.		Indoor Air Temperature (°F DB)													
°F DB	°F WB	60		64		68		70		72		75		86	
		TC	PI	TC	PI	TC	PI	TC	PI	TC	PI	TC	PI	TC	PI
-3	-4	16.80	2.98	16.70	2.99	16.62	2.99	16.58	3.00	16.47	3.03	16.21	3.09	15.44	3.29
0	-1	17.75	3.01	17.61	3.03	17.50	3.05	17.44	3.06	17.31	3.10	17.02	3.16	16.15	3.37
1	0	18.14	3.02	17.99	3.05	17.87	3.08	17.80	3.10	17.66	3.13	17.34	3.16	16.37	3.30
6	5	20.47	3.16	20.26	3.19	20.09	3.23	20.00	3.25	19.80	3.23	19.34	3.20	17.27	3.07
10	9	21.79	3.22	21.55	3.26	21.35	3.30	21.24	3.33	20.97	3.30	20.37	3.25	17.78	3.09
16	14	23.14	3.29	22.87	3.34	22.65	3.38	22.53	3.40	22.16	3.36	21.32	3.29	18.79	3.05
17	15	23.46	3.29	23.18	3.34	22.96	3.39	22.83	3.42	22.44	3.37	21.54	3.29	18.85	3.00
19	17	23.85	3.33	23.57	3.37	23.34	3.40	23.21	3.42	22.77	3.35	21.77	3.25	18.77	2.87
24	23	25.24	3.37	24.94	3.38	24.70	3.39	24.57	3.39	23.97	3.32	22.62	3.20	18.59	2.77
32	30	27.46	3.33	27.14	3.34	26.88	3.34	26.73	3.35	25.92	3.25	24.10	3.11	18.63	2.57
41	38	29.96	3.15	29.61	3.21	29.33	3.27	29.17	3.30	28.20	3.17	26.00	2.97	19.41	2.25
43	40	30.52	3.13	30.16	3.19	29.88	3.25	29.72	3.29	28.68	3.14	26.35	2.93	19.35	2.16
47	43	31.64	3.00	31.27	3.09	30.97	3.19	30.80	3.24	29.66	3.09	27.11	2.85	19.44	2.00
53	50	32.46	3.05	32.06	3.14	31.73	3.23	31.55	3.28	30.30	3.10	27.50	2.84	19.11	1.85
59	53	32.87	2.99	32.84	3.10	32.82	3.21	32.81	3.27	31.46	3.09	28.42	2.83	19.29	1.87
64	57	33.13	2.92	32.64	2.97	32.24	3.01	32.02	3.04	30.73	2.88	27.82	2.66	19.10	1.82
70	61	33.25	2.79	32.67	2.79	32.20	2.78	31.94	2.78	30.66	2.64	27.79	2.44	19.17	1.68
75	65	33.17	2.55	32.50	2.62	31.95	2.69	31.64	2.72	30.34	2.58	27.41	2.36	18.63	1.56

DB: Dry Bulb Temperature (°F) WB: Wet Bulb Temperature (°F) TC: Total Capacity (kBtu/h)

PI: Power Input (kW) (includes compressor, indoor fan motor and outdoor fan motor)

1. All capacities are net, evaporator fan motor heat is deducted.

2. Direct interpolation is permissible. Ⓞ Do not extrapolate..

Capacity as rated: 0 ft. above sea level with 24.6 ft. of refrigerant piping. 0 ft. level difference between outdoor and indoor units.

Heating capacity rating obtained with air entering the indoor unit at 70°F dry bulb (DB) and 60°F wet bulb (WB), and outdoor ambient conditions of 47°F dry bulb (DB) and 43°F wet bulb (WB).

MAXIMUM HEATING CAPACITY

KSSAP301A / KNSAP301A - KUSAP301A

Table 20: KSSAP301A / KNSAP301A - KUSAP301A Maximum Heating Capacities.

Outdoor Air Temp.		Indoor Air Temperature (°F DB)													
°F DB	°F WB	60		64		68		70		72		75		86	
		TC	PI	TC	PI	TC	PI	TC	PI	TC	PI	TC	PI	TC	PI
-3	-4	20.29	3.79	20.18	3.80	20.08	3.81	20.03	3.81	19.89	3.86	19.58	3.93	18.64	4.19
0	-1	21.44	3.83	21.27	3.86	21.14	3.88	21.06	3.90	20.91	3.95	20.56	4.02	19.51	4.29
1	0	21.91	3.84	21.73	3.88	21.58	3.92	21.50	3.94	21.33	3.98	20.94	4.02	19.78	4.20
6	5	24.57	3.97	24.32	4.02	24.11	4.06	24.00	4.09	23.76	4.06	23.22	4.02	20.72	3.86
10	9	26.04	4.01	25.75	4.06	25.51	4.12	25.38	4.14	25.06	4.11	24.33	4.05	21.25	3.85
16	14	27.49	4.05	27.17	4.10	26.91	4.16	26.77	4.18	26.32	4.13	25.32	4.05	22.33	3.76
17	15	27.84	4.04	27.52	4.10	27.25	4.16	27.10	4.20	26.63	4.13	25.56	4.04	22.37	3.69
19	17	28.26	4.07	27.92	4.12	27.65	4.16	27.50	4.18	26.97	4.10	25.79	3.97	22.24	3.51
24	23	29.91	4.14	29.56	4.15	29.27	4.16	29.11	4.17	28.40	4.07	26.81	3.93	22.03	3.41
32	30	32.54	4.12	32.16	4.13	31.85	4.14	31.68	4.15	30.72	4.03	28.56	3.85	22.07	3.19
41	38	35.50	3.94	35.09	4.02	34.76	4.09	34.57	4.13	33.41	3.96	30.81	3.72	23.00	2.82
43	40	36.16	3.93	35.75	4.01	35.40	4.08	35.21	4.12	33.99	3.94	31.22	3.68	22.93	2.71
47	43	37.49	3.79	37.06	3.91	36.70	4.04	36.50	4.10	35.15	3.90	32.13	3.61	23.04	2.53
53	50	38.47	3.86	37.99	3.98	37.60	4.09	37.39	4.15	35.91	3.93	32.59	3.59	22.64	2.35
59	53	38.96	3.78	38.92	3.93	38.89	4.07	38.88	4.14	37.28	3.91	33.67	3.58	22.86	2.36
64	57	39.27	3.70	38.69	3.76	38.21	3.81	37.95	3.84	36.42	3.65	32.97	3.36	22.63	2.30
70	61	39.40	3.54	38.72	3.53	38.16	3.52	37.85	3.52	36.34	3.35	32.93	3.09	22.72	2.13
75	65	39.30	3.23	38.51	3.32	37.86	3.40	37.50	3.45	35.96	3.26	32.49	2.99	22.08	1.98

Performance Data

DB: Dry Bulb Temperature (°F) WB: Wet Bulb Temperature (°F) TC: Total Capacity (kBtu/h)

PI: Power Input (kW) (includes compressor, indoor fan motor and outdoor fan motor)

1. All capacities are net, evaporator fan motor heat is deducted.
2. Direct interpolation is permissible. ⊙ Do not extrapolate..

Capacity as rated: 0 ft. above sea level with 24.6 ft. of refrigerant piping. 0 ft. level difference between outdoor and indoor units.

Heating capacity rating obtained with air entering the indoor unit at 70°F dry bulb (DB) and 60°F wet bulb (WB), and outdoor ambient conditions of 47°F dry bulb (DB) and 43°F wet bulb (WB).

MAXIMUM HEATING CAPACITY

KSSAP361A / KNSAP361A - KUSAP361A

Table 21: KSSAP361A / KNSAP361A - KUSAP361A Maximum Heating Capacities.

Outdoor Air Temp.		Indoor Air Temperature (°F DB)													
°F DB	°F WB	60		64		68		70		72		75		86	
		TC	PI	TC	PI	TC	PI	TC	PI	TC	PI	TC	PI	TC	PI
-3	-4	21.91	4.17	21.78	4.18	21.68	4.19	21.62	4.20	21.47	4.25	21.13	4.33	20.13	4.61
0	-1	23.14	4.22	22.97	4.25	22.82	4.28	22.74	4.29	22.57	4.34	22.19	4.43	21.06	4.72
1	0	23.66	4.23	23.46	4.27	23.30	4.32	23.21	4.34	23.02	4.38	22.61	4.43	21.35	4.62
6	5	26.62	4.35	26.34	4.40	26.12	4.45	26.00	4.48	25.74	4.45	25.15	4.40	22.45	4.23
10	9	28.27	4.38	27.96	4.44	27.71	4.49	27.56	4.52	27.21	4.48	26.43	4.42	23.07	4.20
16	14	29.95	4.40	29.60	4.46	29.32	4.51	29.16	4.54	28.67	4.49	27.59	4.40	24.32	4.08
17	15	30.35	4.38	29.99	4.45	29.70	4.52	29.54	4.55	29.02	4.48	27.86	4.38	24.38	4.00
19	17	30.83	4.42	30.46	4.46	30.17	4.51	30.00	4.53	29.43	4.44	28.14	4.30	24.27	3.80
24	23	32.46	4.48	32.08	4.49	31.76	4.50	31.59	4.51	30.82	4.40	29.09	4.25	23.90	3.68
32	30	35.06	4.44	34.65	4.45	34.32	4.46	34.13	4.47	33.10	4.34	30.77	4.14	23.78	3.43
41	38	37.99	4.23	37.55	4.30	37.19	4.38	36.99	4.42	35.76	4.25	32.97	3.98	24.61	3.02
43	40	38.64	4.21	38.20	4.29	37.83	4.37	37.63	4.41	36.32	4.22	33.36	3.94	24.50	2.90
47	43	39.96	4.04	39.49	4.17	39.11	4.30	38.90	4.37	37.47	4.16	34.24	3.85	24.56	2.70
53	50	41.00	4.11	40.49	4.24	40.07	4.36	39.84	4.42	38.27	4.18	34.74	3.82	24.13	2.50
59	53	41.52	4.03	41.48	4.18	41.45	4.33	41.44	4.41	39.73	4.17	35.89	3.82	24.37	2.52
64	57	41.85	3.94	41.23	4.00	40.72	4.07	40.44	4.10	38.81	3.89	35.14	3.58	24.12	2.45
70	61	41.99	3.77	41.26	3.76	40.67	3.76	40.34	3.75	38.72	3.57	35.10	3.29	24.22	2.27
75	65	41.89	3.44	41.04	3.53	40.35	3.63	39.96	3.67	38.32	3.48	34.62	3.19	23.53	2.11

DB: Dry Bulb Temperature (°F) WB: Wet Bulb Temperature (°F) TC: Total Capacity (kBtu/h)

PI: Power Input (kW) (includes compressor, indoor fan motor and outdoor fan motor)

1. All capacities are net, evaporator fan motor heat is deducted.

2. Direct interpolation is permissible. ⊙ Do not extrapolate..

Capacity as rated: 0 ft. above sea level with 24.6 ft. of refrigerant piping. 0 ft. level difference between outdoor and indoor units.

Heating capacity rating obtained with air entering the indoor unit at 70°F dry bulb (DB) and 60°F wet bulb (WB), and outdoor ambient conditions of 47°F dry bulb (DB) and 43°F wet bulb (WB).

CORRECTION FACTORS

Cooling / Heating Correction Factors

For single zone systems, calculate the equivalent length of the liquid line from the outdoor unit to the indoor unit. Also, determine the elevation difference of the indoor unit above or below the outdoor unit. Find corresponding cooling or heating capacity correction factors as shown below. Multiply the correction factors by the cooling or heating capacity obtained from the capacity table using design conditions. The resultant is the NET cooling or heating capacity.

Refrigerant Line Length Derates

For air-cooled systems, a capacity correction factor will have to be applied to account for the length of the system's refrigerant pipe. Rate of change in capacity due to increased piping lengths is shown below.

Table 22: Extended Piping Cooling and Heating Capacity Coefficient Factors.

Piping Length (ft.)		16.4	24.6	32.8	49.2	65.6	82.0	98.4	114.8	131.2	147.6	164.0
<i>Cooling Capacity Coefficient Factor</i>												
Rate of Capacity Change (%)	KSSAP241A (24,000 Btu/h)	100	100	99.6	98.7	97.8	96.9	96.0	95.1	94.3	93.4	92.5
	KSSAP301A (30,000 Btu/h) and KSSAP361A (36,000 Btu/h)	100	100	99.6	98.7	97.8	96.9	96.0	95.1	94.3	93.4	92.5
<i>Heating Capacity Coefficient Factor</i>												
Rate of Capacity Change (%)	KSSAP241A (24,000 Btu/h)	100	100	99.8	99.3	98.9	98.4	98.0	97.5	97.1	96.6	96.2
	KSSAP301A (30,000 Btu/h) and KSSAP361A (36,000 Btu/h)	100	100	99.8	99.3	98.9	98.4	98.0	97.5	97.1	96.6	96.2

Performance Data

Equivalent Piping Length for Piping Components

Table 23: Equivalent Piping Length for Elbows.

Component	Size (Inches)													
	1/4	3/8	1/2	5/8	3/4	7/8	1	1-1/8	1-1/4	1-3/8	1-1/2	1-5/8	1-3/4	2-1/8
Elbow (ft.)	0.5	0.6	0.7	0.8	1.2	1.3	1.5	1.6	1.8	2.0	2.1	2.3	2.5	2.8

Altitude Correction Factor

The impact of air density must be considered on systems installed at a significant altitude above sea level, therefore, locally accepted altitude correction factors must be applied.

CORRECTION FACTORS / CHECK SELECTION

Defrost Correction Factor for Heating Operation

The outdoor unit heating capacity will need to be adjusted for frost accumulation on air-cooled systems. If design day conditions are below the dewpoint of the surrounding air, frost will not be a problem and no correction factor is needed. In certain weather conditions, however, frost will form and accumulate on the air-cooled outdoor unit coil and impact the coils ability to transfer heat. If significant frost accumulates on the outdoor unit coil, a defrost algorithm will start automatically. The timing between defrost periods is determined by the system's ability to achieve a target head pressure value.

Capacity and AHRI ratings tables do not factor in capacity reduction when frost has accumulated on the condenser coil, nor during defrost operation.

Integrated heating capacity values can be obtained using the formula: **Table 24: Outdoor Unit Frost Accumulation Factor (Heating)¹.**

$$A = B \times C$$

Where:

A = Integrated Heating Capacity.

B = Value found in the Capacity Table.

C = Correction Factor for Frost Accumulation Factor (from table at right).

Entering DB (°F)	19.4	23.0	26.6	32.0	37.4	41.0	44.6
Derate Factor	0.98	0.95	0.93	0.86	0.93	0.96	1.0

¹At 85% outdoor air relative humidity.

The frost accumulation factor does not account for effects of snow accumulation restricting airflow through the outdoor unit coil.

NOTICE

There will be a temporary reduction in capacity when frost / ice accumulates on the outside surface of the outdoor unit heat exchanger. The level of capacity reduction depends on a number of factors, for example, outdoor temperature (°F DB), relative humidity (RH), and the amount of frost present.

Check the Indoor and Outdoor Unit Selection(s)

Compare the corrected cooling and heating capacities to the load calculations. Is each capacity sufficient for the zone it serves?

For each indoor unit, the corrected capacity must be at least equal to the total of the cooling design load (plus ventilation load, if applicable) for the space(s) served by the indoor unit. For each indoor unit, the corrected capacity also must be at least equal to the total of the heating design load (plus ventilation load, if applicable) for the space(s) and / or thermal zones served by the indoor unit.

The outdoor unit selected must be large enough to offset the total cooling load for all spaces it serves (account for ventilation air cooling load if the ventilation air has not been pretreated to room neutral conditions). The outdoor unit must also be large enough to offset the total heating load for all spaces it serves.

If the corrected heating capacity ratio exceeds 100%, reselect the equipment, or change the system design by moving some of the load to another system.

System Sizing Check Formulas

1. Outdoor Unit Rated Capacity.

$Q_{odu(rated)}$ (From capacity tables).

2. Outdoor Unit Capacity at Ti, To Temperature.

$Q_{odu(Ti, To)}$ (From capacity tables).

3. Outdoor Unit Capacity Coefficient Factor.

$F_{(Ti, To)} = Q_{odu(Ti, To)} / Q_{odu(rated)}$

4. Piping Correction Factor (From Capacity Coefficient Factor Tables).

$F_{(length)}$ for each piping length

5. Individual Indoor Unit Combination Capacity.

$Q_{idu(combi)} = Q_{odu(rated)} \times Q_{idu(rated)} / Q_{idu(rated-total)}$

6. Individual Indoor Unit Actual Capacity.

$Q_{idu(actual)} = Q_{odu(combi)} \times F_{(Ti, To)} \times F_{(length, altitude)}$

Conclusions and Recommendations

- Understand the design safety factors.
- Reference load calculations for actual cooling and heating capacities (applies in 99% of applications – consider total load when latent load is greater than 30%).
- Verify that the sensible load of the zone is satisfied.
- Use caution when sizing to meet listed capacity specifications for the scheduled manufacturer's equipment.

If further system design assistance is needed, or you have a unique application you would like to discuss, contact an LG sales rep.

APPLICATION GUIDELINES

Placement / Clearance Considerations for Indoor Units on page 46

Placement / Clearance Considerations for Outdoor Units on page 47

Installing Outdoor Units Indoors on page 51

PLACEMENT / CLEARANCE REQUIREMENTS

Indoor Units

Selecting the Best Location for the Indoor Unit

NOTICE

Follow recommended best practices when choosing an indoor location for the single zone indoor unit.

Dos

Select a location for installing the indoor units that will meet the following conditions:

- Follow the diagram at right for minimum clearance of indoor unit from the top of the unit to the ceiling.
- Clearance gap between any wall or enclosure and the left or right side of the unit must be greater than 4 inches. Ensure there is sufficient maintenance space.
- Unit must be at least 6-1/2 feet from the floor for adequate clearance.
- Place the unit where drainage can be obtained easily and to minimize the length of the condensate drain piping. Condensation drain must be conveniently routed away from the unit.
- Locate the indoor unit in a location where it can be easily connected to the outdoor unit within allowable limits.
- Use a metal detector to locate studs in the walls. Anchor unit following stud location to prevent damage to the wall.
- Place the unit where air circulation will not be blocked.

Do Not

- Do not install the unit near a heat or steam source, or where considerable amounts of oil, iron powder, or flour are used. (These materials will generate condensate, cause a reduction in heat exchanger efficiency, or the drain to malfunction. If this is a potential problem, install a ventilation fan large enough to vent out these materials.)
- Ensure there are no obstacles to air circulation around the unit; keep proper distances from ceilings, doorways, floor, walls, etc.
- Do not install in an area where operation sound will disturb occupants--place the unit where noise prevention is taken into consideration.
- Do not install near doorway.
- Avoid installing the unit near high-frequency generators.

WARNING

The unit must not be installed where oil, sulfuric acid and flammable or corrosive gases are generated, vented into, or stored. There is risk of fire, explosion, and physical injury or death.

NOTICE

- Indoor units (IDUs) must not be placed in an environment where the IDUs will be exposed to harmful volatile organic compounds (VOCs) or in environments where there is improper air make up or supply or inadequate ventilation. If there are concerns about VOCs in the environment where the IDUs are installed, proper air make up or supply and / or adequate ventilation should be provided. Additionally, in buildings where IDUs will be exposed to VOCs consider a factory-applied epoxy coating to the fan coils for each IDU.
- If the unit is installed near a body of water, the installation parts are at risk of corroding. Appropriate anti-corrosion methods must be taken for the unit and all installation parts.

The unit will be damaged, will malfunction, and / or will not operate as designed if installed in any of the conditions listed.

Installing in an Area Exposed to Unconditioned Air

In some installation applications, areas (floors, walls) in some rooms will be exposed to unconditioned air (room will be above or next to an unheated garage or storeroom). To countermeasure:

- Verify that carpet is or will be installed (carpet will increase the temperature by three degrees).
- Add insulation between the floor joists.
- Install radiant heat or another type of heating system to the floor.

Figure 19: Extended Piping Wall-Mounted Indoor Unit Clearance Requirements.

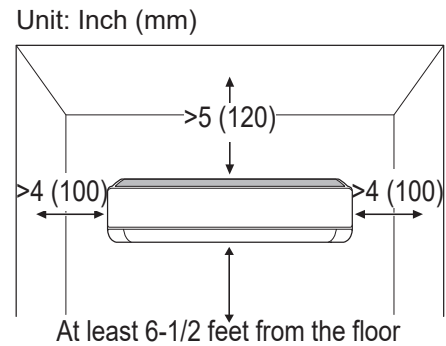
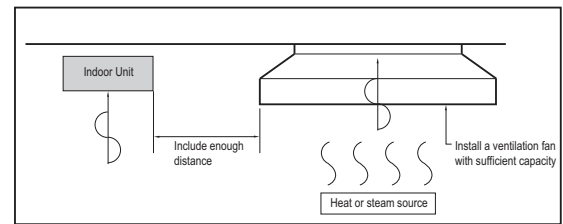

Figure 20: Installing Near a Heat or Steam Source.



PLACEMENT / CLEARANCE CONSIDERATIONS

Indoor Units / Outdoor Units

Selecting the Best Location for the Indoor Unit, continued.



Installing Indoor Units in an Area with High Humidity Levels

If the environment is prone to humidity levels of 80% or more (near the ocean, lakes, etc.) or where steam could collect.

- Install additional insulation to the indoor unit (glass wool insulation >13/32 inches thick).
- Install additional insulation to the refrigerant piping (insulation >13/16 inches thick).
- Seal all gaps between the indoor unit and the wall (make the area air tight) so that humidity does not transfer to the conditioned space.

Selecting the Best Location for the Outdoor Unit

⚠ DANGER

-  Do not install the unit in an area where combustible gas will generate, flow, stagnate, or leak. These conditions can cause a fire, resulting in bodily injury or death.
-  Do not install the unit in a location where acidic solution and spray (sulfur) are often used as it can cause bodily injury or death.
-  Do not use the unit in environments where oil, steam, or sulfuric gas are present as it can cause bodily injury or death.

⚠ WARNING

When deciding on a location to place the outdoor unit, be sure to choose an area where run-off from defrost will not accumulate and freeze on sidewalks or driveways, which will create unsafe conditions. Properly install and insulate any drain hoses to prevent the hose from freezing, cracking, leaking, and causing unsafe conditions from frozen condensate.

Install a fence to prevent pests from crawling into the unit or unauthorized individuals from accessing it. Pests and unauthorized individuals can damage internal components which can cause a fire, electric shock, physical injury or death. Follow the placement guidelines set forth in "Clearance Requirements".

Select a location for installing the outdoor unit that will meet the following conditions:

Do's

- Where there is enough strength to bear the weight of the unit.
- A location that allows for optimum air flow and is easily accessible for inspection, maintenance, and service.
- Where piping between the outdoor unit and indoor unit is within allowable limits.
- Include space for drainage to ensure condensate flows properly out of the unit when it is in heating mode.  Avoid placing the outdoor unit in a low-lying area where water could accumulate.
- If the outdoor unit is installed in a highly humid environment (near an ocean, lake, etc.), ensure that the site is well-ventilated and has a lot of natural light (Example: Install on a rooftop).

Do Nots

- Where it will be subjected to direct thermal radiation from other heat sources, or an area that would expose the outdoor unit to heat or steam like discharge from boiler stacks, chimneys, steam relief ports, other air conditioning units, kitchen vents, plumbing vents, and other sources of extreme temperatures.
- Where high-frequency electrical noise / electromagnetic waves will affect operation.
- Where operating sound from the unit will disturb inhabitants of surrounding buildings.
- Where the unit will be exposed to direct, strong winds.
- Where the discharge of one outdoor unit will blow into the inlet side of an adjacent unit (when installing multiple outdoor units).

NOTICE

The indoor unit may take longer to provide heat, or heating performance will be reduced in winter if the outdoor unit is installed:

1. In a narrow, shady location.
2. Near a location that has a lot of ground moisture.
3. In a highly humid environment.
4. In an area in which condensate does not drain properly.

Outdoor Unit Condensate Drain Piping

Outdoor unit requires condensate drain piping. Condensate drain pipe is constructed with materials approved by local code. See pages 48-50 for information in reference to outdoor unit placement.

PLACEMENT / CLEARANCE CONSIDERATIONS

Outdoor Units

Planning for Snow and Ice

To ensure the outdoor unit operates properly, certain measures are required in locations where there is a possibility of heavy snowfall or severe windchill or cold:

1. Prepare for severe winter wind chills and heavy snowfall, even in areas of the country where these are unusual phenomena.
2. Position the outdoor unit so that its airflow fans are not buried by direct, heavy snowfall. If snow piles up and blocks the airflow, the system will malfunction.
3. Remove any snow that has accumulated four (4) inches or more on the top of the outdoor unit.
4. In climates that will experience significant snow buildup, mount the outdoor unit on a raised, field-provided platform or stand. The raised support platform must be high enough to allow the unit to remain above possible snow drifts, and must be higher than the maximum anticipated snowfall for the location.
5. Design the mounting base to prevent snow accumulation on the platform in front or back of the unit frame.
6. Provide a field fabricated snow protection hood to keep snow and ice and/or drifting snow from accumulating on the coil surfaces.
7. To prevent snow and heavy rain from entering the outdoor unit, install the condenser air inlets and outlets facing away from direct winds.
8. Consider tie-down requirements in case of high winds or where required by local codes.

⚠ CAUTION

When deciding on a location to place the outdoor unit, be sure to choose an area where run-off from defrost will not accumulate and freeze on sidewalks or driveways, which will create unsafe conditions.

NOTICE

Choose an area where run-off from defrost mode will not accumulate and freeze on sidewalks or driveways. Properly install and insulate any drain hoses to prevent the hose from freezing, cracking, leaking, and damaging the outdoor unit.

Tie-Downs, Lightning Protection, and Wind Protection

Tie-Downs

- The strength of the roof must be checked before installing the outdoor units.
- The strength of the outdoor unit frames is adequate to be used with field-provided wind restraint tie-downs.
- If the installation site is prone to high winds or earthquakes, when installing on the wall or roof, securely anchor the mounting base using a field-provided tie-down configuration approved by a local professional engineer.
- The overall tie-down configuration must be approved by a local professional engineer.

NOTICE

Always refer to local code when using a wind restraint system.

Lightning Protection

- To protect the outdoor unit from lightning, it must be placed within the specified lightning safety zone.

Table 25: Safety Zone Specifications.

Building Height (feet)	66	98	148	197
Protection Angle (°)	55	45	35	25

- Power cable and communication cable must be installed five (5) feet away from lightning rod.
- A high-resistance ground system must be included to protect against induced lightning or indirect strike.

Figure 21: Lightning Protection Diagram (Outdoor Unit Appearances Differ According to Model).

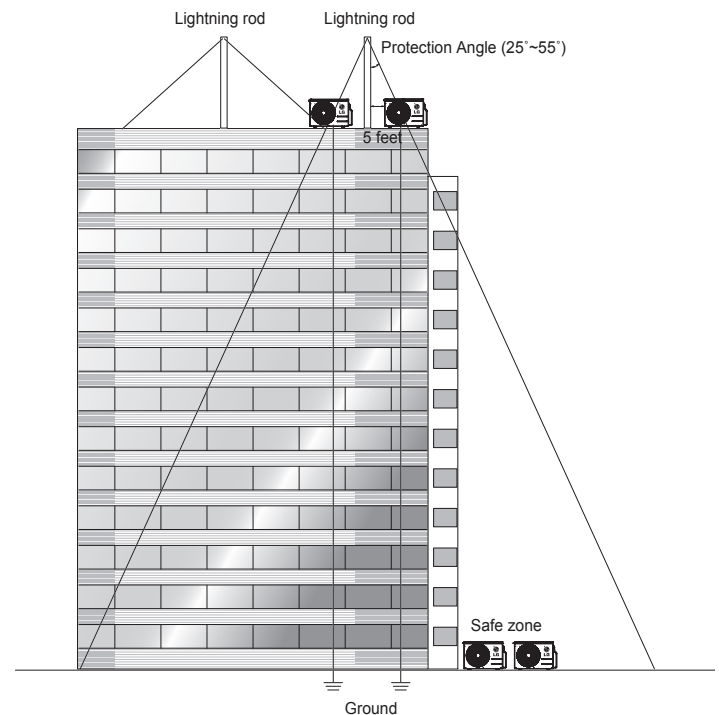

NOTICE

If the building does not include lightning protection, the outdoor unit will be damaged from a lightning strike. Inform the customer of this possibility in advance.

PLACEMENT / CLEARANCE CONSIDERATIONS

Outdoor Units

Oceanside Applications

Wind Protection

If the outdoor unit is placed on a roof, position it with the compressor end (no coil surface) in the direction of the prevailing wind as shown in the figure at right. In cooler climates, it may be beneficial to position the unit in direct sunlight to assist with defrost operations.

If the outdoor unit is not placed on a roof, place it on the leeward side of the building or in a location where the unit will not be exposed to constant wind.

If placement exposes the unit to constant wind activity, construct a wind break in front of the unit. Follow the placement guidelines set forth in "Clearance Requirements".

Figure 22: Prevailing Wind Direction.

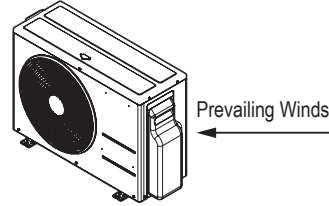
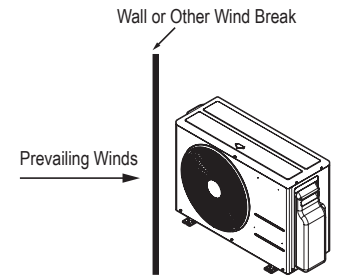

Figure 23: Leeward Side of the Building.



Figure 24: Wind Break.



Oceanside Application Precautions

NOTICE

Ocean winds will cause corrosion, particularly on the condenser and evaporator fins, which, in turn could cause product malfunction or inefficient performance.

- ⚠ Avoid installing the outdoor unit where it would be directly exposed to ocean winds.
- Install the outdoor unit on the side of the building opposite from direct ocean winds.
- Select a location with good drainage.
- Periodically clean dust or salt particles off of the heat exchanger with water.

If the outdoor unit must be placed in a location where it would be subjected to direct ocean winds, install a concrete windbreaker strong enough to block any winds. Windbreaker height and width must be more than 150% of the outdoor unit, and be installed at least 14 to 28 inches away from the outdoor unit to allow for airflow (depending on the location and outdoor unit size).

NOTICE

Additional anti-corrosion treatment may need to be applied to the outdoor unit at oceanside locations.

Figure 25: Oceanside Placement Using a Building as Shield, and Placement Using a Windbreak.

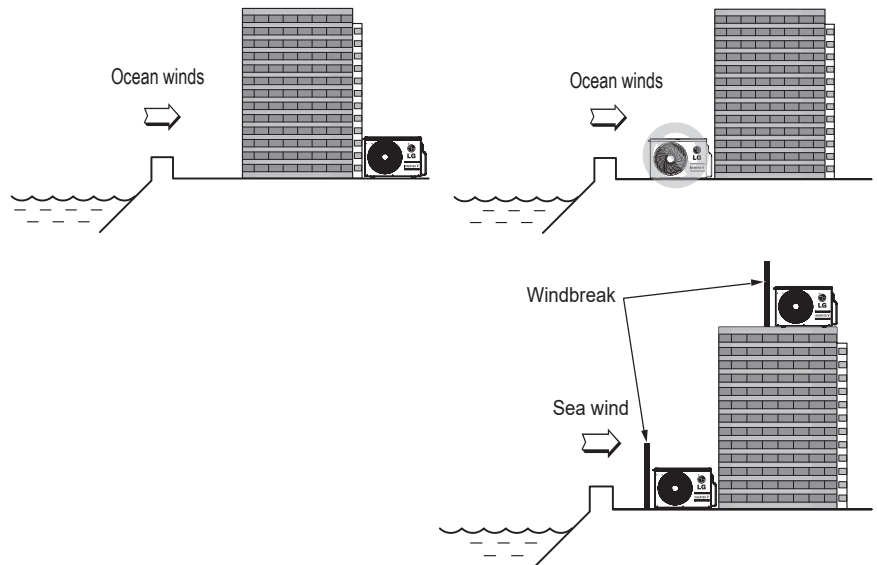

PLACEMENT / CLEARANCE CONSIDERATIONS

Outdoor Units

Minimum Allowable Clearance and Service Access Requirements

Proper clearance for the outdoor unit coil is critical for proper unit operation. When installing the outdoor unit, consider service, inlet and outlet and minimum allowable space requirements as illustrated in the diagrams on the page below.

- Include enough space for airflow and for service access. If installing multiple outdoor units, ⚠ avoid placing the units where the discharge of one unit will blow into the inlet side of an adjacent unit.
- If an awning is built over the unit to prevent direct sunlight or rain exposure, make sure that the discharge air of the outdoor unit isn't restricted.
- ⚠ No obstacles to air circulation around the unit; keep proper distances from ceilings, fences, floor, walls, etc. (Install a fence to prevent pests from damaging the unit or unauthorized individuals from accessing it.)

Minimum Clearance Requirements for Single Fan Outdoor Units

Specific clearance requirements in the diagram below are for single fan outdoor units. The figure below shows the overall minimum clearances that must be observed for safe operation and adequate airflow around the outdoor unit.

When placing the outdoor unit under an overhang, awning, sunroof or other "roof-like structure", observe the clearance requirements (as shown in Cases 1 and 2) for height in relation to the unit. To have successful service access to the outdoor unit, see the figure below for minimum spacing. When installing multiple outdoor units, see Cases 4 and 5 for correct spacing requirements.

NOTICE

If the outdoor unit is installed between standard and minimum clearances, capacity decreases approximately 10%.

Figure 26: Single Fan Outdoor Unit Service Access and Allowable Clearances Diagram.

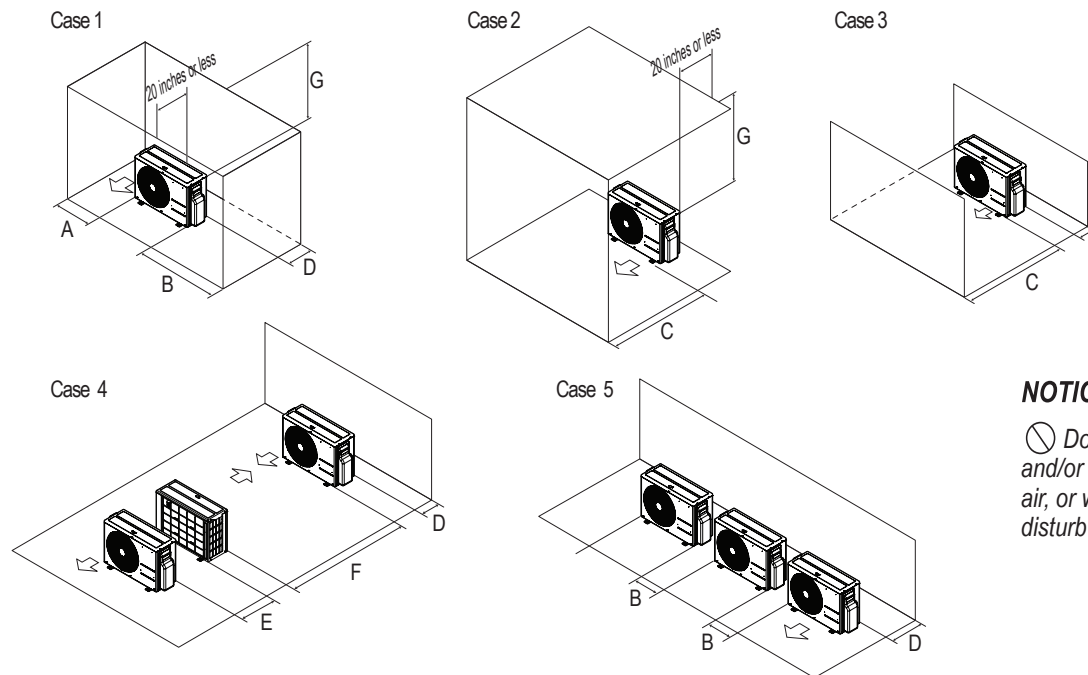

NOTICE

⚠ Do not place the unit where animals and/or plants will be in the path of the warm air, or where the warm air and/or noise will disturb neighbors.

Table 26: Single Fan Outdoor Unit Service Access and Allowable Clearances Diagram Legend.

Unit: Inch		A	B	C	D	E	F	G
Case 1	Standard	12	24	-	12	-	-	-
	Minimum	4	10	-	4	-	-	40
Case 2	Standard	-	-	20	-	-	-	-
	Minimum	-	-	14	-	-	-	40
Case 3	Standard	-	-	20	12	-	-	-
	Minimum	-	-	14	4	-	-	-
Case 4	Standard	-	-	-	12	24	-	-
	Minimum	-	-	-	4	8	79	-
Case 5	Standard	-	24	-	12	-	-	-
	Minimum	-	10	-	4	-	-	-

INSTALLING OUTDOOR UNITS INDOORS

Installing Outdoor Units Indoors

Single Zone outdoor units are engineered to be mounted outdoors and include technology designed to minimize the negative effects of winter weather's freezing rain, sleet, and snow. Some building projects, however, necessitate placing the HVAC outdoor units indoors:

- Lack of ground space.
- Lack of an appropriate outdoor location that meets system design requirements.
- When mounting on the roof is not an option due to a lack of roof space.
- Roof warranty will be voided if mechanical equipment is placed on the membrane.
- On retrofit projects, a former chiller / boiler / air handler equipment room, mechanical area, or penthouse already exists.
- To curtail the potential need for redundant zone heating devices such as wall-fin radiators or duct heaters.
- In extremely cold environments where there is a significant amount of run-time at temperatures well below freezing outside the outdoor unit ambient air temperature range published in this engineering manual.

Benefits of Installing Outdoor Units Indoors

- Shelters the outdoor unit from direct exposure to prevailing winds that decrease the heating capability of the outdoor unit.
- Protects equipment from freezing precipitation and / or potential ice build-up that could hinder unit operation.
- Maintains coil heat transfer efficiency by reducing the number of and shortening the cycle time for defrost operation.
- Easier maintenance and servicing during inclement weather.
- When mounted in a fully enclosed space, limiting the ambient air temperature will allow the Single Zone system designer to eliminate oversizing.
- The outdoor unit to compensate for loss of capacity at low ambient temperatures.
- Will also curtail the need to provide inefficient redundant zone heating devices such as wall-fin radiators and second-stage ancillary heating devices.

Design Considerations Include:

- Enclosure types and elements such as louvers (see next page), rain hoods, dampers and controls, heating methods and sizing of heating devices.
- Heating strategies.
- Duct design.
- Condensate handling.

General Guidelines

- Follow ASHRAE 62.1 design guidelines.
- Depending on the project / application, a roof over the outdoor units in combination with a wind break will be all that is necessary.
- Consider the potential for snow accumulation near louvers / roof openings. Outside air intakes and discharge ducts / louvers must be engineered to clear anticipated snow accumulation levels by at least one (1) foot.
- In situations where operation is anticipated at temperatures lower than the product's minimum operating temperature, ancillary heat must be provided to heat the outdoor unit coils to ensure continuous compressor operation and heating.

It may be necessary to use a field-fabricated air guide to prevent discharge air from short-cycling back to the coil inlet.

- Consider the direction of prevailing winds and opening placement. If possible, locate inlet openings upwind of discharge openings and other exhaust outlets.
- When inlet and outlet openings are placed on the same wall, minimum distance between the two openings must be approximately three (3) feet (minimum distance varies significantly with variations in outlet opening face velocity).
- If roof-mounted ventilation openings are used, strategically locate the inlet ventilation opening(s) upwind of the outlet opening(s).
- Discharge and supply ductwork must be designed to avoid weather related long periods of water entrainment.

INSTALLING OUTDOOR UNITS INDOORS

Provide a means to drain the condensate generated during heating mode and defrost cycle in addition to rainwater that infiltrates the inlet louver enclosed area.

- Install a field-provided drain pan under the outdoor units and provide a path to a nearby floor drain.
- If the ambient air temperature is expected to drop below 32°F in the enclosure, heat the bottom surface of the pan, drain line, and floor drain so that the condensate does not freeze before reaching the drain.

⚠ CAUTION

When deciding on a location to place the outdoor unit, be sure to choose an area where run-off from defrost will not accumulate and freeze on walkways, which will create unsafe conditions.

Allow for ventilation intake and exhaust air based on maximum outdoor unit fan capacity.

- Select the size, type and orientation of architectural louvers with adequate “net free area” face velocity to ensure the total external static pressure from the outdoor unit fan does not exceed design limitations (see specification data tables).
-  No obstructions must be placed in front of the louver that could hamper the free flow (throw) of air.
- Roof top openings and / or discharge and supply louvers must be equipped with screens to prevent bird and insect infiltration.

NOTICE

For louver recommendations, see below and on the next page.

As always, the best solution for each project balances acceptable heating performance (considering local weather conditions), capital costs, life cycle energy consumption, and limitations set forth by local building codes.

Louver Recommendations for Outdoor Unit Enclosure

1. Outdoor Unit Enclosure: Manual Door Open Type.
2. Louver Angle: No More Than 15° Horizontally.
3. Space Between Louvers: More than four (4) inches (Recommend).
4. Louver Shape: Wing or Plane Type.

NOTICE

- Open Rate and Inlet must be taken into consideration when designing the louvered outdoor unit enclosure.
-  Do not use “S” type louvers.

NOTICE

If the Louver Open Rate is Too Small

1. Noise can occur because of the increased air velocity passing through the louver blade.
2. Noise can occur from louver blade vibrations.
3. A drop in outdoor unit fan performance (excess static pressure can cause a drop in outdoor unit performance and heat exchanger efficiency).
4. If the louver open rate is too small or there is insufficient air flow exchange, the air conditioner might stop operating.

Figure 27: Louver Recommendations.

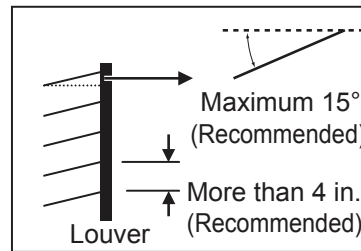
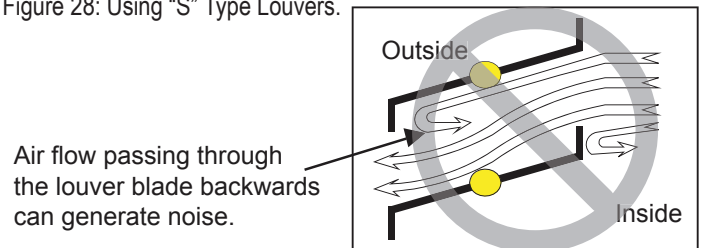

Figure 28: Using “S” Type Louvers.



INSTALLING OUTDOOR UNITS INDOORS

Open Rate by Louver Radian

Figure 29: Open Rate by Louver Radian Formula.

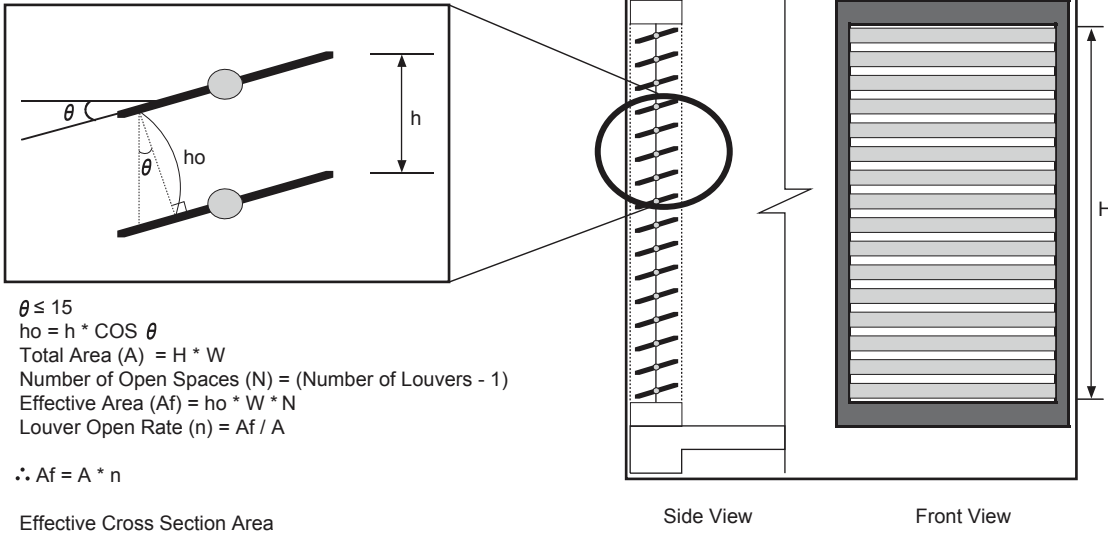

Confirming Air Flow Rate / Total Opening Rate

• Example: KUSAP241A

• Discharge Airflow Rate: 2,119 ft.³/min.

• Velocity of Outlet Air: 15.1 ft./s

• Velocity of Inlet Air: 6.5 ft./s

• Open Rate = 80% or More

$$\text{Open Rate} = \frac{\text{Effective Face Area (Af)}}{\text{Total Face Area (A)}}$$

- Inlet airflow must match or exceed discharge airflow.
- Separate inlet airflow from discharge airflow to prevent recirculation.

Formula

- Total Louver Dimension (Excluding Frame) (A) = 3.9 feet x 6.2 feet = 24.2 ft.²
- Area Blocked by Outdoor Unit (Discharge) (B) = 2.6 feet x 2.8 feet = 7.41 ft.²
- Inlet Louver Dimension (A - B) = 16.8 ft.²
- Equivalent Inlet Dimension (Open Rate 80%) = 16.8 ft.² x 0.8 = 13.44 ft.²
- Equivalent Inlet Airflow = 13.44 ft.² x 6.5 ft./s x 60 sec./min. = 5,242 ft.³/min.
- Equivalent Inlet Airflow / Discharge Airflow = 5,242 ft.³/min. / 2,119 ft.³/min. = 247% (Within Allowable Limits)

Figure 30: Example of Installing Outdoor Unit Indoors.
Louver Dimensions Air Guide Duct on Outdoor Unit

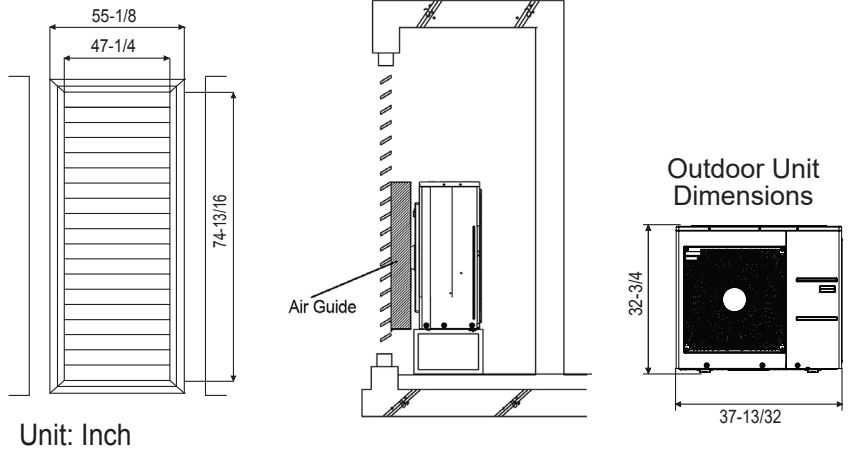

REFRIGERANT PIPING DESIGN

Refrigerant Flow Diagrams on page 55

Connection Limitations and System Layout on page 57

Additional Refrigerant Charge on page 58

Refrigerant Piping System Engineering on page 59

REFRIGERANT FLOW DIAGRAMS

KSSAP241A / KNSAP241A - KUSAP241A

NOTICE

Various tools are available to assist in properly designing LG R32 split systems. Refer to the "R32 Application Guide"; the "Simple Calculator for Capacity, Refrigerant Charge and ESP"; the "LG Air Conditioner Technical Solutions" (LATS) software program; and the local LG Sales Representative.

Figure 31: KSSAP241A / KNSAP241A - KUSAP241A Refrigerant Flow Diagram.

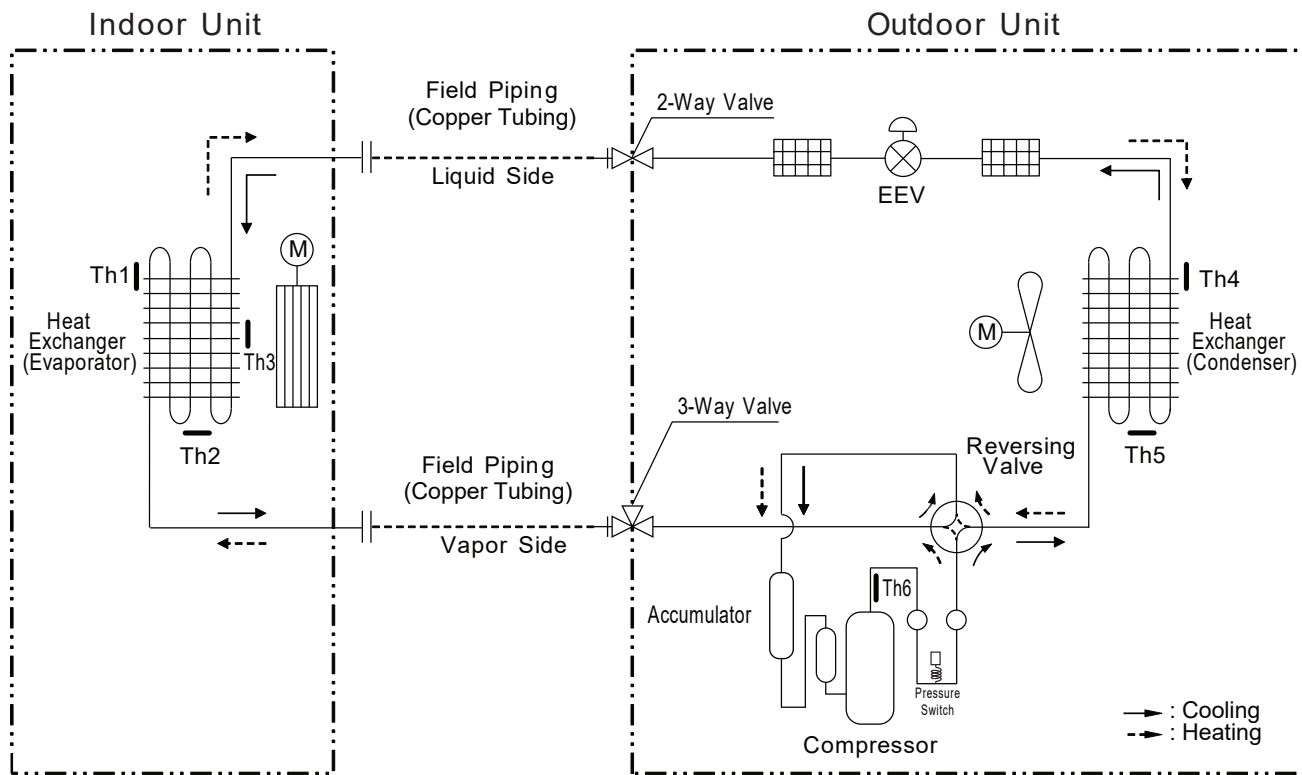

Refrigerant Piping Design

Appendix		Heat Exchanger		Propeller Fan		Cross Flow Fan		Compressor		Accumulator		Reversing Valve (4 Way Valve)		
		EEV (Electronic Expansion Valve)		Capillary Tube		2-Way Valve		3-Way Valve		Temperature Sensor		Pressure Sensor		Pressure Switch
		Check Valve		Flare Joint		Muffler		Strainer						

Table 27: KSSAP241A / KNSAP241A - KUSAP241A Thermistor Details.

Thermistor	Description	PCB Connector
TH1	Indoor Air Temperature Thermistor	CN-TH1 (Indoor)
TH2	Water Level Sensor (Optional)	CN-TH2 (Indoor)
TH3	Evaporator Temperature Thermistor	CN-TH3 (Indoor)
TH4	Outdoor Air Temperature Thermistor	CN-TH1 (Outdoor)
TH5	Condenser Temperature Thermistor	
TH6	Discharge Pipe Temperature Thermistor	CH-TH2 (Outdoor)

Table 28: KSSAP241A / KNSAP241A - KUSAP241A Refrigerant Piping / Connection Sizes.

Model	Vapor (in.)	Liquid (in.)
KSSAP241A	Ø5/8	Ø3/8



REFRIGERANT FLOW DIAGRAMS

KSSAP301A / KNSAP301A - KUSAP301A, KSSAP361A / KNSAP361A - KUSAP361A

NOTICE

Various tools are available to assist in properly designing LG R32 split systems. Refer to the "R32 Application Guide"; the "Simple Calculator for Capacity, Refrigerant Charge and ESP"; the "LG Air Conditioner Technical Solutions" (LATS) software program; and the local LG Sales Representative.

Figure 32: KSSAP301A / KNSAP301A - KUSAP301A and KSSAP361A / KNSAP361A - KUSAP361A Refrigerant Flow Diagram.

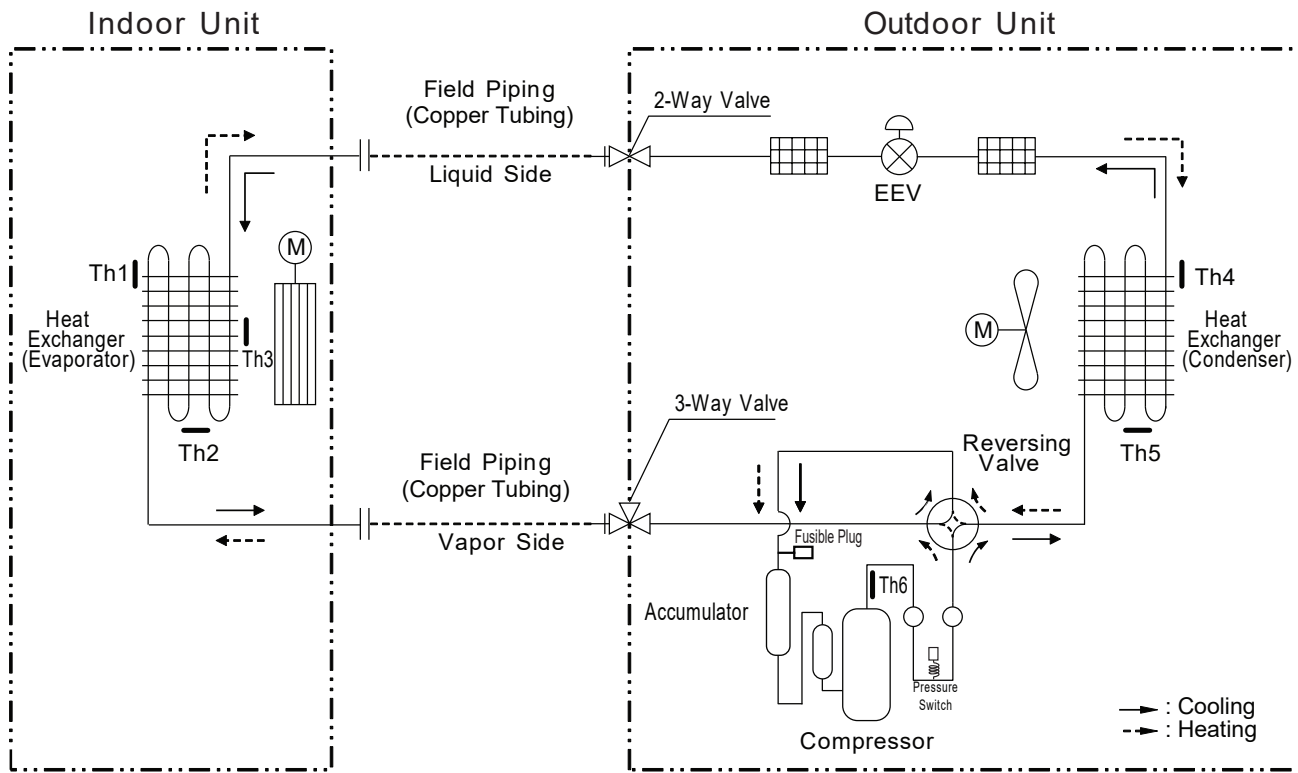

Appendix		Heat Exchanger		Propeller Fan		Cross Flow Fan		Compressor		Accumulator		Reversing Valve (4 Way Valve)
		EEV (Electronic Expansion Valve)		Capillary Tube		2-Way Valve 3-Way Valve		Temperature Sensor		Pressure Sensor		Pressure Switch
		Check Valve		Flare Joint		Muffler		Strainer				

Table 29: KSSAP301A / KNSAP301A - KUSAP301A and KSSAP361A / KNSAP361A - KUSAP361A Thermistor Details.

Thermistor	Description	PCB Connector
TH1	Indoor Air Temperature Thermistor	CN-TH1 (Indoor)
TH2	Water Level Sensor (Optional)	CN-TH2 (Indoor)
TH3	Evaporator Temperature Thermistor	CN-TH3 (Indoor)
TH4	Outdoor Air Temperature Thermistor	CN-TH1 (Outdoor)
TH5	Condenser Temperature Thermistor	
TH6	Discharge Pipe Temperature Thermistor	CH-TH2 (Outdoor)

Table 30: KSSAP301A / KNSAP301A - KUSAP301A and KSSAP361A / KNSAP361A - KUSAP361A Refrigerant Piping / Connection Sizes.

Model	Vapor (in.)	Liquid (in.)
KSSAP301A, KSSAP361A	Ø5/8	Ø3/8

CONNECTION LIMITATIONS / SYSTEM LAYOUT

NOTICE

Various tools are available to assist in properly designing LG R32 split systems. Refer to the "R32 Application Guide"; the "Simple Calculator for Capacity, Refrigerant Charge and ESP"; the "LG Air Conditioner Technical Solutions" (LATS) software program; and the local LG Sales Representative.

Connection Limitations

Single-zone systems consist of one outdoor unit and one indoor unit. One of the most critical elements of a single zone system is the refrigerant piping. If the connection piping is not within allowable limits, there will be reliability, performance, noise, and vibration issues. The table below lists pipe length limits that must be followed in the design of a Single Zone Extended Piping refrigerant pipe system. Refer to the figure(s) for maximum length and elevation of piping.

NOTICE

Depending on system and proposed / installed pipe length, it may be required to calculate maximum refrigerant charge to determine if the system complies with applicable regulations / standards. For residential applications, a refrigerant charge less than 4.1 lbs. complies with ASHRAE 15.2 and does not require additional calculation/consideration of maximum refrigerant charge for release in a space.

Table 31: Single-Zone Extended Piping Refrigerant Piping System Limitations.

System Model No.		KSSAP241A	KSSAP301A	KSSAP361A
Liquid Piping (in.)	Connection / Pipe Size	3/8 / 3/8	3/8 / 3/8	3/8 / 3/8
Vapor Piping (in.)	Connection / Pipe Size Vapor	5/8 / 5/8	5/8 / 5/8	5/8 / 5/8
Pipe Length (ELF = Equivalent Length of Pipe)	Standard length (no add'l refrigerant)	24.6 feet	24.6 feet	24.6 feet
	Longest total equivalent piping length	164.0 feet	164.0 feet	164.0 feet
	Shortest total equivalent piping length	9.8	9.8	9.8
	Distance between fittings and indoor or outdoor units	≥20 inches	≥20 inches	≥20 inches
Elevation (All Elevation Limitations are Measured in Actual Feet)	If outdoor unit is above indoor unit	98.4 feet	98.4 feet	98.4 feet
	If outdoor unit is below indoor unit	98.4 feet	98.4 feet	98.4 feet
Additional Refrigerant Needed (oz. /ft.)		0.32	0.32	0.32

System Layout

Figure 33: Typical Single Zone Extended Piping Wall Mounted System Layout.

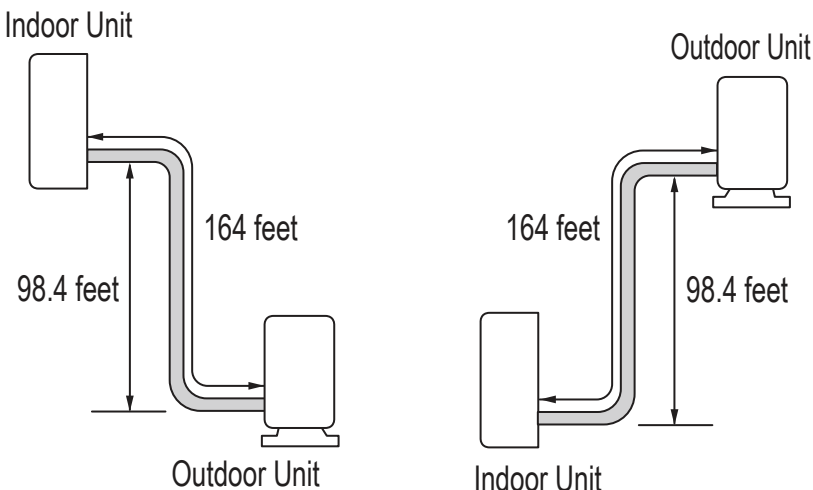

ADDITIONAL REFRIGERANT CHARGE

NOTICE

Various tools are available to assist in properly designing LG R32 split systems. Refer to the "R32 Application Guide"; the "Simple Calculator for Capacity, Refrigerant Charge and ESP"; the "LG Air Conditioner Technical Solutions" (LATS) software program; and the local LG Sales Representative.

Additional Refrigerant Charge

Each outdoor unit is factory charged (nameplate charge) for the evaporator as well as having a standard foot line (for each single zone system; listed in the specification tables). Any time a line set is used longer than the standard foot line set length for the single zone system, the refrigerant charge has to be adjusted.

The charge must be adjusted on the ounces of R32 (listed in the specification tables) per foot based on how many feet of piping are added. The factory charge accommodates pipe lengths up to the standard (no additional refrigerant) length without requiring refrigerant removal. See table below for information on the additional refrigerant charges necessary for longer piping lengths. Refer to the previous page for maximum piping length and additional charge amount per additional foot of pipe length.

Table 32: Single-Zone Extended Piping System Additional Refrigerant by Piping Length (oz.).

System Model No.		Refrigerant Piping Length (feet)											
		16.4	24.6	32.8	41.0	49.2	65.6	82.0	98.4	114.8	131.2	147.6	164.0
KSSAP241A	Additional Refrigerant Charge (oz.)	0	0	2.6	5.3	7.9	13.2	18.4	23.7	28.9	34.2	39.4	44.7
KSSAP301A and KSSAP361A		0	0	2.6	5.3	7.9	13.2	18.4	23.7	28.9	34.2	39.4	44.7

- Values are in ounces (oz.).
- Capacity is based on standard length; maximum allowance length is based on reliability.
- Equivalent Pipe Length = Actual Pipe Length + Number of Bends x 0.3.
- Calculation: $X \text{ oz.} = ([\text{Refrigerant Piping Length}] - [\text{Chargeless Length}]) \times \text{Additional Refrigerant}$.

Example for KSSAP241A:

A 41 foot line set is used: Additional 16.4 feet x 0.32 oz. per foot = Add 5.25 oz. of refrigerant.

NOTICE

If the unit charge is unknown, reclaim, evacuate, and weigh in the correct charge using the unit nameplate (capacity) charge adjusting for line sets longer than the "chargeless" amount. This will prevent any interruptions to unit operation and possible damage.

REFRIGERANT PIPING SYSTEM ENGINEERING

NOTICE

Various tools are available to assist in properly designing LG R32 split systems. Refer to the “R32 Application Guide”; the “Simple Calculator for Capacity, Refrigerant Charge and ESP”; the “LG Air Conditioner Technical Solutions” (LATS) software program; and the local LG Sales Representative.

Selecting Field-Supplied Copper Piping

NOTICE

Always follow local codes when selecting and installing copper pipe and piping system components.

Approved piping for use with LG Single Zone products will be marked “R32 RATED” along the length of the pipe. Piping wall thickness must meet local code requirements and be approved for a maximum operating pressure of 626 psi. When bending piping, try to keep the number of bends to a minimum, and use the largest radii possible to reduce the equivalent length of installed piping; also, bending radii greater than ten (10) piping diameters can minimize pressure drop. Be sure no traps or sags are present.

For Single Zone Systems

LG prefers the use of ACR copper piping rated at the system working pressure was used.

NOTICE

Always properly support the piping as per the instructions on page 63.

Table 33: ACR Rated Copper Tubing Material.

Type	Seamless Phosphorous Deoxidized
Class	UNS C12200 DHP
Straight Lengths	H58 Temper
Coils	O60 Temper

Table 34: Piping Tube Thicknesses.

OD (in.)	1/4	3/8	1/2	5/8	3/4	7/8	1-1/8	1-3/8
Material	Rigid or Soft ACR Rated for R32				Rigid or Soft ACR Rated for R32			
Min. Bend Radius (in.)	0.563	0.9375	1.5	2.25	3.0	3.0	3.5	4.0
Min. Wall Thickness (in.)	0.030	0.030	0.030	0.030	0.030	0.030	0.030	0.040

Table 35: ACR Copper Tubing Dimensions and Physical Characteristics¹⁻³.

Nominal Pipe Outside Diameter (in.)	Actual Outside Diameter (in.)	Drawn Tempered (Hard)			Annealed Temper (Soft)		
		Nominal Wall Thickness (in.)	Weight (lb. / ft.)	Cubic ft. per Linear ft.	Nominal Wall Thickness (in.)	Weight (lb. / ft.)	Cubic ft. per Linear ft.
1/4	0.250	-	-	-	0.030	0.0804	0.00020
3/8	0.375	0.030	0.126	0.00054	0.032	0.134	0.00053
1/2	0.500	0.035	0.198	0.00101	0.032	0.182	0.00103
5/8	0.625	0.040	0.285	0.00162	0.035	0.251	0.00168
3/4	0.750	0.042	0.362	0.00242	0.035	0.305	0.00252
7/8	0.875	0.045	0.455	0.00336	0.045	0.455	0.00336
1-1/8	1.125	0.050	0.655	0.00573	0.050	0.655	0.00573
1-3/8	1.375	0.055	0.884	0.00875	0.055	0.884	0.00875

¹All dimensions provided are in accordance with ASTM B 280 – Standard.

²Design pressure = 626 psig.

³The Copper Tube Handbook: Industry Standard Guide for the Design and Installation of Copper Piping Systems; Copper Development Association Inc., Copper Alliance; https://www.copper.org/publications/pub_list/pdf/copper_tube_handbook.pdf.

NOTICE

- Commercially available piping often contains dust and other materials. Always blow it clean with a dry inert gas.
- Prevent dust, water or other contaminants from entering the piping during installation.

REFRIGERANT PIPING SYSTEM ENGINEERING

NOTICE

Various tools are available to assist in properly designing LG R32 split systems. Refer to the “R32 Application Guide”; the “Simple Calculator for Capacity, Refrigerant Charge and ESP”; the “LG Air Conditioner Technical Solutions” (LATS) software program; and the local LG Sales Representative.

Copper Expansion and Contraction

Under normal operating conditions, the vapor pipe temperature of a Single Zone System can vary as much as 280°F. With this large variance in pipe temperature, the designer must consider pipe expansion and contraction to avoid pipe and fitting fatigue failures.

Refrigerant pipe along with the insulation jacket form a cohesive unit that expands and contracts together. During system operation, thermal heat transfer occurs between the pipe and the surrounding insulation.

If the pipe is mounted in free air space, no natural restriction to movement is present if mounting clamps are properly spaced and installed. In extreme cases, the restrictive force of surface friction between insulating jackets could become so great that natural expansion ceases and the pipe is “fixed” in place. In this situation, opposing force caused by change in refrigerant fluid / vapor temperature can lead to pipe/fitting stress failure.

The refrigerant pipe support system must be engineered to allow free expansion to occur. When a segment of pipe is mounted between two fixed points, provisions must be provided to allow pipe expansion to naturally occur. The most common method is the inclusion of expansion Loop or U-bends. Each segment of pipe has a natural fixed point where no movement occurs. This fixed point is located at the center point of the segment assuming the entire pipe is insulated in a similar fashion. The natural fixed point of the pipe segment is typically where the expansion Loop or U-bend must be.

Linear pipe expansion can be calculated using the following formula:

$$LE = C \times L \times (T_r - T_a) \times 12$$

LE	=	Anticipated linear tubing expansion (in.)
C	=	Constant (For copper = 9.2×10^{-6} in./in.°F)
L	=	Length of pipe (ft.)
T_r	=	Refrigerant pipe temperature (°F)
T_a	=	Ambient air temperature (°F)
12	=	Inches to feet conversion (12 in./ft.)

See table on next page for precalculated anticipated expansion for various pipe sizes and lengths of refrigerant tubing.

To find the anticipated expansion value:

1. From the table on the next page, find the row corresponding with the actual feet of the straight pipe segment.
2. Estimate the minimum and maximum temperature of the pipe.
3. In the column showing the minimum pipe temperature, look up the anticipated expansion distance corresponding to the segment length. Do the same for the maximum pipe temperature.
4. Calculate the difference in the two expansion distance values. The result will be the change in pipe length.

1. From the “Linear Thermal Expansion of Copper Tubing in Inches” Table on the next page, find the row corresponding with the actual length of the straight pipe segment.
2. Estimate the minimum and maximum temperature of the pipe. In the column showing the minimum pipe temperature, look up the anticipated expansion distance. Do the same for the maximum pipe temperature.
3. Calculate the difference in the two expansion distance values. The result will be the anticipated change in pipe length.

General Example:

A system is installed and the design shows that there is a 100 foot straight segment of tubing between an indoor unit and the outdoor unit. In heating, this pipe transports hot gas vapor to the indoor units at 120°F. In cooling, the same tube is a suction line returning refrigerant vapor to the outdoor unit at 40°F. Look up the copper tubing expansion at each temperature and calculate the difference.

Vapor Line

Transporting Hot Vapor: 100 ft. pipe at 120°F = 1.40 in.

Transporting Suction Vapor: 100 ft. pipe at 40°F = 0.40 in.

Anticipated Change in Length: 1.40 in. – 0.40 in. = 1.00 in.

Liquid Line

The liquid temperature remains relatively the same temperature; only the direction of flow will reverse. Therefore, no significant change in length of the liquid line is anticipated.

When creating an expansion joint, the joint height must be a minimum of two times the joint width. Although different types of expansion arrangements are available, the data for correctly sizing an Expansion Loop is provided in the “Radii of Coiled Expansion Loops and Developed Lengths of Expansion Offsets” Table on the next page. Use soft copper with long radius bends on longer runs or long radius elbows for shorter pipe segments. Using the anticipated linear expansion (LE) distance calculated, look up the Expansion Loop or U-bend minimum design dimensions. If other types of expansion joints are chosen, design per ASTM B-88 Standards.

REFRIGERANT PIPING SYSTEM ENGINEERING

NOTICE

Various tools are available to assist in properly designing LG R32 split systems. Refer to the "R32 Application Guide"; the "Simple Calculator for Capacity, Refrigerant Charge and ESP"; the "LG Air Conditioner Technical Solutions" (LATS) software program; and the local LG Sales Representative.

Table 36: Linear Thermal Expansion of Copper Tubing in Inches.

Pipe Length ¹	Fluid Temperature °F																			
	35°	40°	45°	50°	55°	60°	65°	70°	75°	80°	85°	90°	95°	100°	105°	110°	115°	120°	125°	130°
10	0.04	0.04	0.05	0.06	0.06	0.07	0.08	0.08	0.09	0.09	0.10	0.10	0.11	0.11	0.11	0.12	0.13	0.14	0.15	0.15
20	0.08	0.08	0.10	0.12	0.13	0.14	0.15	0.16	0.17	0.18	0.19	0.20	0.21	0.22	0.22	0.23	0.26	0.28	0.29	0.30
30	0.12	0.12	0.15	0.18	0.20	0.21	0.23	0.24	0.26	0.27	0.29	0.30	0.32	0.33	0.32	0.35	0.39	0.42	0.44	0.45
40	0.16	0.16	0.20	0.24	0.26	0.28	0.30	0.32	0.34	0.36	0.38	0.40	0.42	0.44	0.43	0.46	0.52	0.56	0.58	0.60
50	0.20	0.20	0.25	0.30	0.33	0.35	0.38	0.40	0.43	0.45	0.48	0.50	0.53	0.55	0.54	0.58	0.65	0.70	0.73	0.75
60	0.24	0.24	0.30	0.36	0.39	0.42	0.45	0.48	0.51	0.54	0.57	0.60	0.63	0.66	0.65	0.69	0.78	0.84	0.87	0.90
70	0.28	0.28	0.35	0.42	0.46	0.49	0.53	0.56	0.60	0.63	0.67	0.70	0.74	0.77	0.76	0.81	0.91	0.98	1.02	1.05
80	0.32	0.32	0.40	0.48	0.52	0.56	0.60	0.64	0.68	0.72	0.76	0.80	0.84	0.88	0.86	0.92	1.04	1.12	1.16	1.20
90	0.36	0.36	0.45	0.54	0.59	0.63	0.68	0.72	0.77	0.81	0.86	0.90	0.95	0.99	0.97	1.04	1.17	1.26	1.31	1.35
100	0.40	0.40	0.50	0.60	0.65	0.70	0.75	0.80	0.85	0.90	0.95	1.00	1.05	1.10	1.08	1.15	1.30	1.40	1.45	1.50
120	0.48	0.48	0.60	0.72	0.78	0.84	0.90	0.96	1.02	1.08	1.14	1.20	1.26	1.32	1.30	1.38	1.56	1.68	1.74	1.80
140	0.56	0.56	0.70	0.84	0.91	0.98	1.05	1.12	1.19	1.26	1.33	1.40	1.47	1.54	1.51	1.61	1.82	1.96	2.03	2.10
160	0.64	0.64	0.80	0.96	1.04	1.12	1.20	1.28	1.36	1.44	1.52	1.60	1.68	1.76	1.73	1.84	2.08	2.24	2.32	2.40
180	0.72	0.72	0.90	1.08	1.17	1.26	1.35	1.44	1.53	1.62	1.71	1.80	1.89	1.98	1.94	2.07	2.34	2.52	2.61	2.70

¹Pipe length baseline temperature = 0°F. ²Expansion of Carbon, Copper and Stainless Steel Pipe, "The Engineers' Toolbox," www.engineeringtoolbox.com.

Figure 34: Coiled Expansion Loops and Offsets (Plan View).

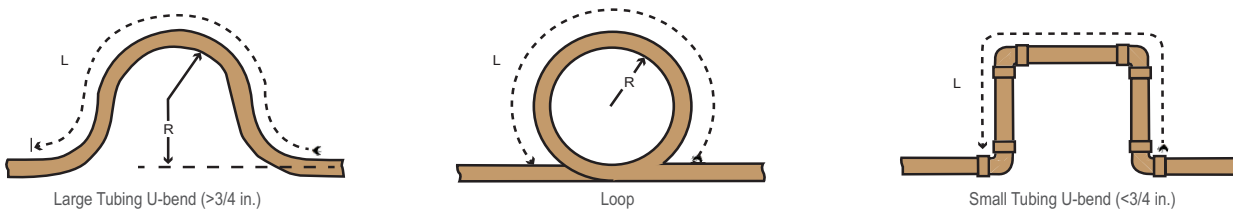

NOTICE

All expansion loops and offsets must be installed in the horizontal plane to prevent the possibility of trapping oil. Loops and offsets in vertical risers must also be installed in a horizontal plane.

Table 37: Radii of Coiled Expansion Loops and Developed Lengths of Expansion Offsets. (See *The Copper Tube Handbook: Industry Standard Guide for the Design and Installation of Copper Piping Systems*; Copper Development Association Inc., Copper Alliance; https://www.copper.org/publications/pub_list/pdf/copper_tube_handbook.pdf for additional information.)

Anticipated Linear Expansion (LE) (inches)		Nominal Tube Size (OD) inches			
		1/4	3/8	1/2	3/4
1/2	R ¹	6	7	8	9
	L ²	38	44	50	59
1	R ¹	9	10	11	13
	L ²	54	63	70	83
1-1/2	R ¹	11	12	14	16
	L ²	66	77	86	101
2	R ¹	12	14	16	19
	L ²	77	89	99	117
2-1/2	R ¹	14	16	18	21
	L ²	86	99	111	131
3	R ¹	15	17	19	23
	L ²	94	109	122	143
3-1/2	R ¹	16	19	21	25
	L ²	102	117	131	155
4	R ¹	17	20	22	26
	L ²	109	126	140	166

¹R = Centerline Length of Pipe.

²L = Centerline Minimum Radius (inches).

REFRIGERANT PIPING SYSTEM ENGINEERING

NOTICE

Various tools are available to assist in properly designing LG R32 split systems. Refer to the “R32 Application Guide”; the “Simple Calculator for Capacity, Refrigerant Charge and ESP”; the “LG Air Conditioner Technical Solutions” (LATS) software program; and the local LG Sales Representative.

Proper system operation depends on the installer using utmost care while assembling the piping system. The following pages are an overview of best practices when installing the refrigerant piping system.

NOTICE

LG Electronics U.S.A., Inc., is not responsible for any piping calculations, refrigerant leaks, degradation of performance, any other potential problems or damages caused by the interconnecting piping, their joint connections, isolation valves, or introduced debris inside the piping system.

⊘ No Pipe Size Substitutions

Use only the pipe size selected by the information in this manual. Using a different size is prohibited and will result in a system malfunction or failure to work at all.

⊘ No In-line Refrigeration Components

Components such as oil traps, solenoid valves, filter-driers, sight glasses, tee fittings, and other after-market accessories are ⊘ not permitted on the refrigerant piping system between the outdoor units and the indoor units. LG Single Zone systems are provided with redundant systems that make sure oil is properly returned to the compressor. Sight-glasses and solenoid valves will cause vapor to form in the liquid stream. Over time, driers will deteriorate and introduce debris into the system. The designer and installer must verify the refrigerant piping system is free of traps, sagging pipes, sight glasses, filter driers, etc.

Field-Provided Isolation Ball Valves

LG maintains a neutral position on using isolation valves in LG HVAC refrigerant piping systems. LG does not endorse any manufacturer of isolation valves. It is recognized that installing isolation valves will simplify future maintenance requirements, and, if used, considerations must be taken including, but not limited to, the following:

- Pressure drops for any component used, including isolation valves, must be known in equivalent pipe length and calculated into the total and segment equivalent piping lengths and compared to product design limitations.
- In all cases, materials must be suitable for the application and any applicable codes, including, but not limited to, diameter and wall thickness continuity per ACR standards.

Failure to do so will cause significant performance degradation. Proper leak checks must be performed. Using isolation valves does not automatically void any LG product warranty, however, a limited warranty will be voided in whole or part if any field supplied accessory fail in any way that causes product failure.

Using Elbows

Field-supplied elbows are allowed if they are long radius and designed for use with R32 refrigerant. The designer and installer, however, must be cautious with the quantity and size of fittings used, and must account for the additional pressure losses in equivalent pipe length calculation for each branch. The equivalent pipe length of each elbow must be added to each pipe segment in the LATS program.

Pipe Bends

When bending soft copper, use long radius bends. Refer to the “Radii of Coiled Expansion Loops and Developed Lengths of Expansion Offsets” table on the previous page for minimum radius specifications.

REFRIGERANT PIPING SYSTEM ENGINEERING

NOTICE

Various tools are available to assist in properly designing LG R32 split systems. Refer to the "R32 Application Guide"; the "Simple Calculator for Capacity, Refrigerant Charge and ESP"; the "LG Air Conditioner Technical Solutions" (LATS) software program; and the local LG Sales Representative.

Obstacles

When an obstacle, such as an I-beam or concrete T, is in the path of the planned refrigerant pipe run, it is best practice to route the pipe over the obstacle. If adequate space is not available to route the insulated pipe over the obstacle, then route the pipe under the obstacle. In either case, it is imperative the length of the horizontal section of pipe above or below the obstacle be a minimum of three (3) times the longest vertical rise (or fall) at either end of the segment.

Figure 35: Installing Piping Above and Below an Obstacle.

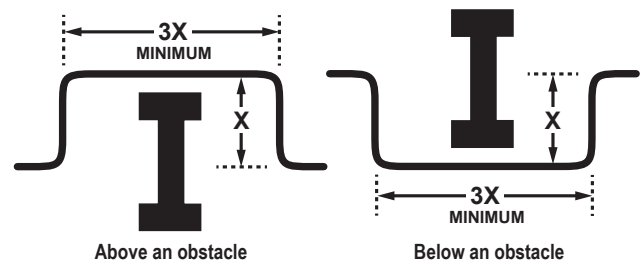

Pipe Supports

A properly installed pipe system must be adequately supported to avoid pipe sagging. Sagging pipes become oil traps that lead to equipment malfunction.

Pipe supports must \odot never touch the pipe wall; supports must be installed outside (around) the primary pipe insulation jacket. Insulate the pipe first because pipe supports must be installed outside (around) the primary pipe insulation jacket. Clevis hangers must be used with shields between the hangers and insulation. Field provided pipe supports must be designed to meet local codes. If allowed by code, use fiber straps or split-ring hangers suspended from the ceiling on all-thread rods (fiber straps or split ring hangers can be used as long as they do not compress the pipe insulation). Place a second layer of insulation over the pipe insulation jacket to prevent chafing and compression of the primary insulation within the confines of the support pipe clamp.

A properly installed pipe system will have sufficient supports to avoid pipes from sagging during the life of the system. As necessary, place supports closer for segments where potential sagging could occur. Maximum spacing of pipe supports must meet local codes. If local codes do not specify pipe support spacing, pipe must be supported:

- Maximum of five (5) feet on center for straight segments of pipe up to 3/4 inches outside diameter size.
- Maximum of six (6) feet on center for pipe up to one (1) inch outside diameter size.
- Maximum of eight (8) feet on center for pipe up to two (2) inches outside diameter size.

Wherever the pipe changes direction, place a hanger within twelve (12) inches on one side and within twelve (12) to nineteen (19) inches of the bend on the other side.

Support piping at indoor unit(s) as shown.

Figure 36: Pipe Hanger Details.

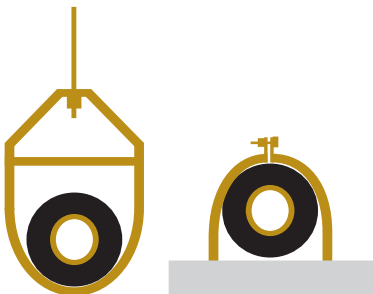

Figure 37: Typical Pipe Support Location—Change in Pipe Direction.

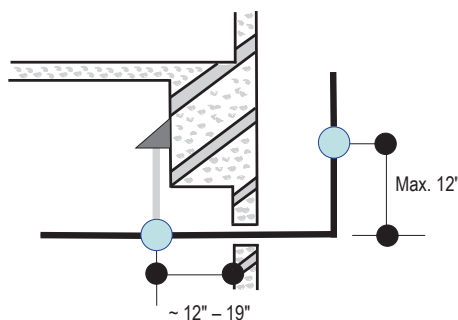
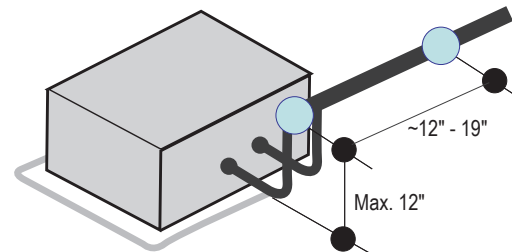

Figure 38: Pipe Support at Indoor Unit.



NOTICE

Use a 4" + long sheet curved sheet metal saddles between hanger bracket and insulation to promote linear expansion/contraction.

REFRIGERANT PIPING SYSTEM ENGINEERING

NOTICE

Various tools are available to assist in properly designing LG R32 split systems. Refer to the "R32 Application Guide"; the "Simple Calculator for Capacity, Refrigerant Charge and ESP"; the "LG Air Conditioner Technical Solutions" (LATS) software program; and the local LG Sales Representative.

Pipe Sleeves at Penetrations

LG recommends that all pipe penetrations through walls, floors, and pipes buried underground be properly insulated and routed through an appropriate wall sleeve of sufficient size to prevent compression of refrigerant pipe insulation and free movement of the pipe within the sleeve. Use 4" + curved sheet metal saddles between the bottom surface of the pipe and the bottom surface of the penetration.

Figure 39: Pipe Sleeve Options.

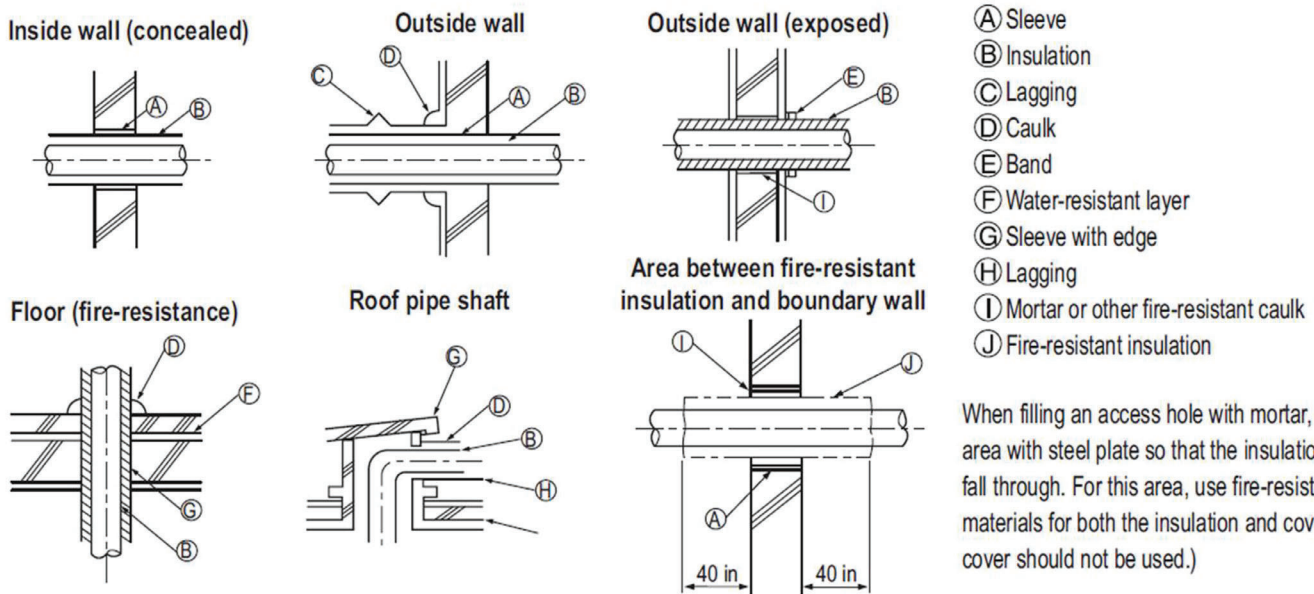

When filling an access hole with mortar, cover the area with steel plate so that the insulation will not fall through. For this area, use fire-resistant materials for both the insulation and cover. (Vinyl cover should not be used.)

NOTICE

Diameter of penetrations must be determined by pipe diameter plus the thickness of the insulation.

ELECTRICAL

General Guidelines on page 66

Wiring Diagrams on page 67

Power Supply / Power Wiring on page 69

Communication / Connection Cable on page 70

Controllers on page 71

GENERAL GUIDELINES

General Electrical Guidelines

⚠ WARNING

- *Separately wire the high and low voltage lines. There is a risk of electric shock, physical injury, or death.*
- *Use heat-proof electrical wire capable of withstanding temperatures up to 167°F to avoid wiring malfunction and electrical shock, which may cause physical injury or death.*
- *Power wiring and communication cables must be firmly attached to the terminals; connect the wiring so that the wires cannot be easily pulled out. Loose wiring may cause unit malfunction, the wires to burnout or the terminal to overheat and catch fire. There is a risk of electric shock, physical injury or death.*
- *Terminal screws will become loose during transport. Properly tighten the terminal connections during installation or risk electric shock, physical injury, or death.*
- *Use outdoor and waterproof connection cable rated up to 300V for the connection between the indoor and outdoor unit to avoid electrical shock, which may cause physical injury or death.*

NOTICE

- *Separately wire the high and low voltage lines to avoid damage to units.*
- *⊘ Do not install power wiring to the outdoor unit and the communication / connection (power) cable to the indoor unit in the same conduit. Use separate conduits.*
- *Local codes may require field-installed disconnect switches from outdoor unit to indoor unit.*
- *Use heat-proof electrical wire capable of withstanding temperatures up to 167°F to avoid damage to unit.*
- *Always use a circuit breaker or time delay fuse when connecting electrical wiring to the unit.*
- *Power wiring and communication cables must be firmly attached to the terminals. Loose wiring may cause unit malfunction, the wires to burnout or the terminal to overheat and catch fire. There is a risk of equipment malfunction or property damage.*
- *Terminal screws will become loose during transport. Properly tighten the terminal connections during installation or risk equipment malfunction or property damage. There is a risk of equipment malfunction or property damage.*
- *Use outdoor and waterproof connection cable rated up to 300V for the connection between the indoor and outdoor unit to avoid damage to the unit.*
- *Comply with local codes while running wire from the indoor unit to the outdoor unit.*
- *⊘ Do not allow wire to touch refrigerant piping, the compressor or any moving parts since it can lead to mechanical failure.*

WIRING DIAGRAMS

KUSAP241A, KUSAP301A, and KUSAP361A Outdoor Units

Figure 40: KUSAP241A, KUSAP301A, and KUSAP361A Outdoor Unit Wiring Diagram.

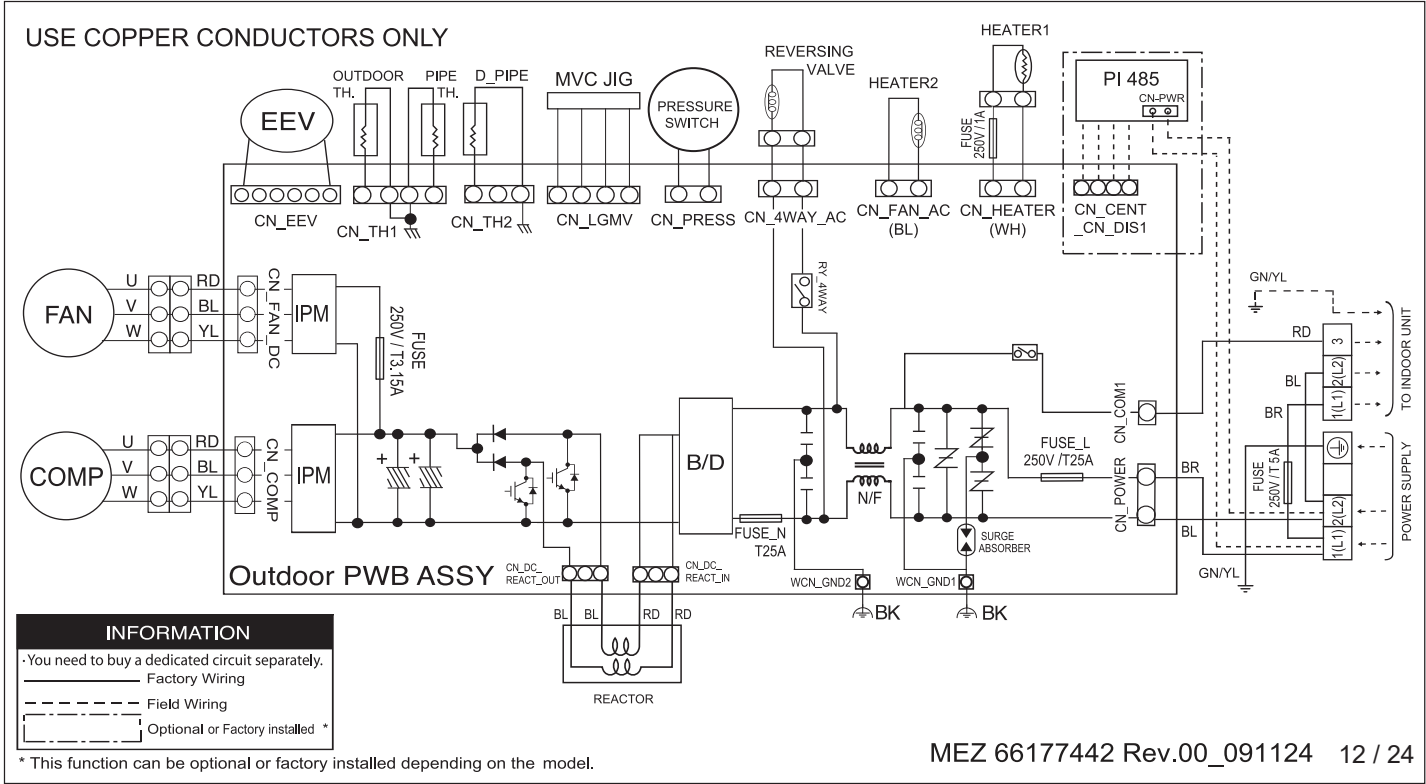

WIRING DIAGRAMS

KNSAP241A, KNSAP301A, KNSAP361A Indoor Units

Figure 41: KNSAP241A, KNSAP301A, and KNSAP361A Indoor Unit Wiring Diagram.

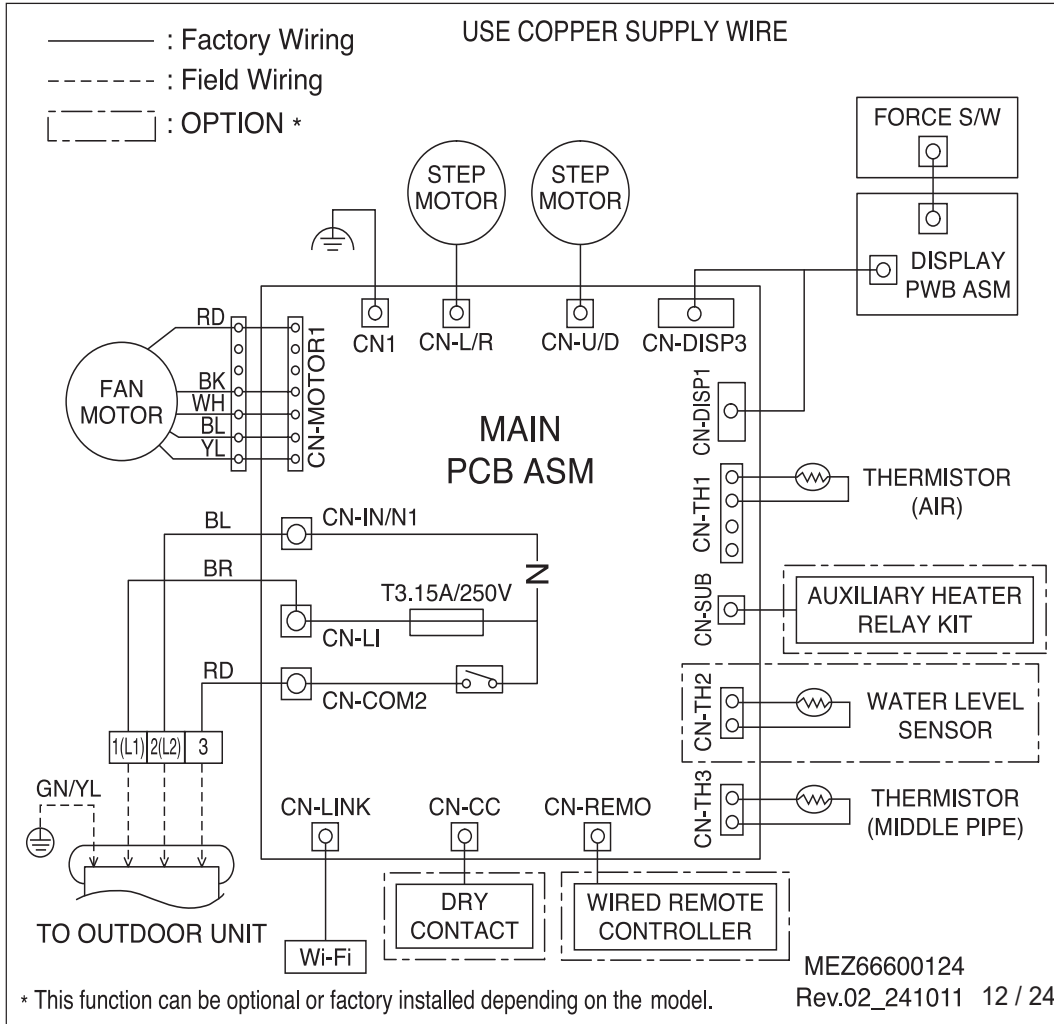

Table 38: KNSAP241A, KNSAP301A, and KNSAP361A Indoor Unit Wiring Diagram Legend.

Terminal	Purpose	Function
CN_MOTOR1	Fan motor output	Motor Output of BLDC
CN1	N / A	N / A
CN-L/R	Step Motor	Step Motor Connection
CN-U/D	Step Motor	Step Motor Connection
CN-DISP3	Display	Indoor Status Display Connection
CN-DISP1	Display	Indoor Status Display Connection
CN-TH1	Air Thermistor	Air Thermistor Connection
CN-SUB	Auxiliary Heater Relay Kit	Auxiliary Heater Relay Kit Connection
CN-TH2	Water Level Sensor (optional)	Water Level Sensor Connection (option)
CN-TH3	Mid Pipe Thermistor	Mid Pipe Thermistor
CN-REMO	Wired Remote Controller	Wired Remote Controller Connection
CN-CC	Dry Contact	Dry Contact Connection
CN-LINK	Wi-fi	Wi-fi Module Connection
CN-COM2 / CN-LI / CN-IN/N1	Power / Communication	Outdoor Unit Power / Communication Connection

POWER SUPPLY / POWER WIRING

Power Supply / Power Wiring

- LG Extended Piping single zone systems operate at 1Ø, 208-230V, 60Hz; confirm power source specifications
- Follow manufacturer's circuit diagrams displayed on the inside of the control box cover.
- It is recommended that a circuit breaker is installed, especially if conditions could become wet or moist.
- Include a disconnect in the power wiring system. Add an air gap contact separation of at least 1/8 inch in each active (phase) conductor.
- Power wiring to the outdoor unit(s) must be solid or stranded, and must comply with all National Electrical Code (NEC), UL, and local electrical codes.
- Power supply to the outdoor unit must be selected based on NEC and local codes. Maximum allowable voltage fluctuation $\pm 10\%$ or nameplate rated value. Confirm that the electrical capacity is sufficient.

A voltage drop will cause the following problems:

- Magnetic switch vibration, fuse breaks, or disturbance to the normal function of an overload protection device.
- Compressor will not receive the proper starting current.
- Any openings where the field wiring enters the cabinet must be completely sealed.
- Properly ground the outdoor unit and the indoor unit per National Electrical Code (NEC) and local codes.
- The indoor unit is powered by the outdoor unit. See the next page for communication / connection (power) cable specifications from the outdoor unit to the indoor unit.
- Ground wire must be longer than the common power / communication wires.
- Always match color codes of each wire and follow wiring diagram.

Figure 42: Circuit Breaker.

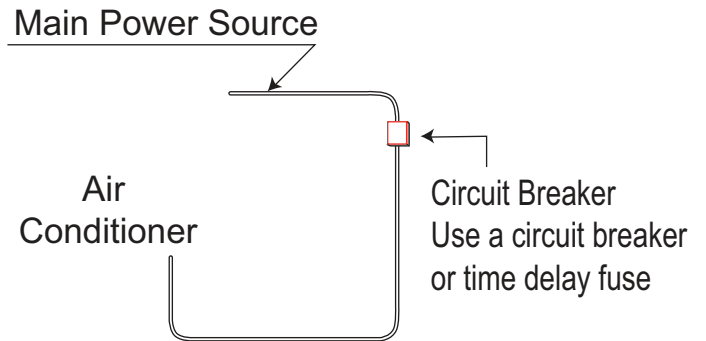
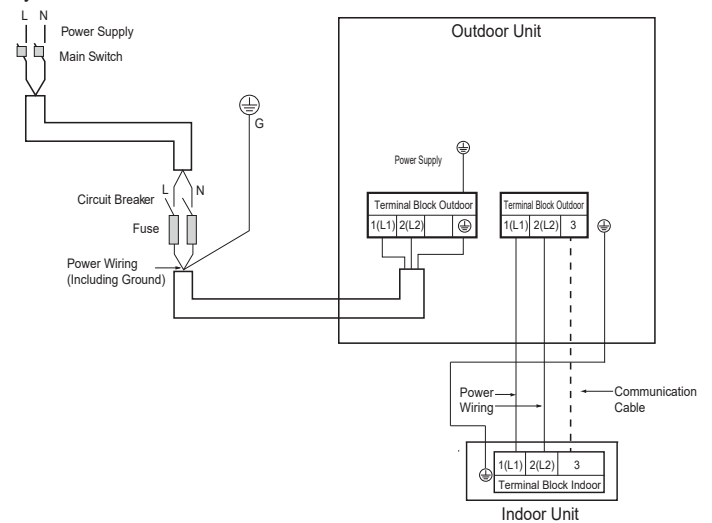

Figure 43: Extended Piping Single Zone System Power / Communications System Schematic.



COMMUNICATION / CONNECTION CABLE

Communication / Connection (Power) Cable Specifications from Outdoor Unit to Indoor Unit

- Communication / connection (power) cable from the single zone outdoor unit to the indoor unit must use a minimum of 14 AWG, four (4) conductor, stranded, shielded or unshielded (if shielded, it must be grounded to the chassis of the outdoor unit only), and must comply with applicable local and national codes.
- Use of 14 AWG, four (4) conductor, stranded, shielded or unshielded wire is allowed for lengths up to the published maximum pipe length, plus recommended slack at both ends.
- Insulation material as required by local code.
- Firmly attach the cable; provide slack but secure in a way to prevent external forces from being imparted on the terminal block.
- Wiring must be completed without splices.

⚠ WARNING

All power wiring and communication cable installation must be performed by trained service providers working in accordance with local, state, and National Electrical Code (NEC) / UL / ETL federal regulations related to electrical equipment and wiring, and following the manufacturer product diagrams, requirements, and instructions in this manual. Failure to do so will lead to electric shock which can cause physical injury or death.

NOTICE

- Always verify the communication cable is connected to a communications terminal on the single zone unit. ⚠ Never apply line voltage power to the communication cable connection. If contact is made, the PCBs will be damaged.
- The shield of the communications cable connecting the outdoor unit to the indoor unit must be grounded only to the outdoor unit frame.
- Tie the shield of each cable segment together using a wire nut at the indoor unit. Maintain polarity throughout the communication network.
- Position the incoming power to the outdoor unit away from the power / communications cables from the outdoor unit to the indoor unit.
- ⚠ Never use a common multiple-core communications cable.

NOTICE

- Make sure the communications cable / power wiring from the outdoor unit to the indoor unit and the power wiring to the outdoor unit are separate, otherwise, the outdoor unit operation will be affected by electrical noise and will malfunction or fail.
- Use a conduit for the communications cable / power wiring from the outdoor unit to the indoor units.

Figure 44: Single Zone Extended Piping Outdoor Unit to Indoor Unit Wiring and Communications Cable Diagram.

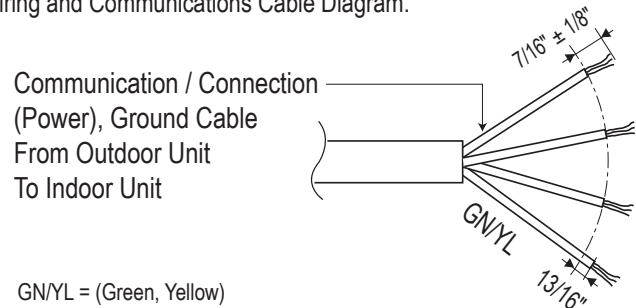

GN/YL = (Green, Yellow)

Figure 45: Single Zone Extended Piping Wall-Mounted Power / Communication System Diagram.

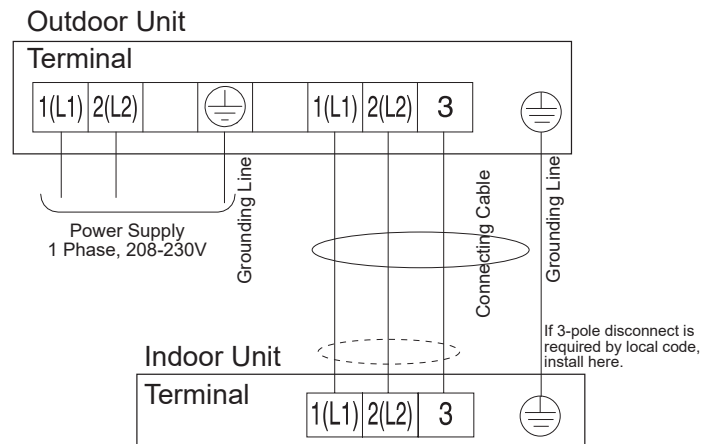

Controller Options

Single Zone Extended Piping Wall Mounted systems include a wireless handheld remote controller (Part No. AKB76044208). Optional LG-supplied wired controllers are available. See “Functions, Controls, Options”, or contact an LG representative for more information.

Wireless Handheld Remote Controller features:

- Display Panel: Displays operation conditions.
- On / Off Button: Turns system operation on and off.
- Mode Button: Selects the operation mode: Cooling → Auto → Dehumidification → Heating → Fan.
- Temp. (Temperature) Up / Down Buttons: Adjusts the desired room temperature in the different modes.
- Fan Speed Button (+ / -): Sets desired fan speed.
- Reset: Resets / initializes the handheld remote control settings.

NOTICE

Each function will display on the LED for about three (3) seconds when the power is first cycled on.

Figure 46: AKB76044208 Wireless Handheld Remote Controller.

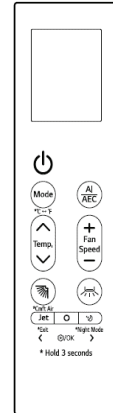

Wired Controller Connection

Extended Piping wall-mounted indoor units have a Molex plug on the PCB for wired controller connection (CN-REMO). To connect the wall-mounted indoor units to the wired controllers, choose from either a 30-foot LG Wired Remote Extension Cable (PZCWRC1), or an LG Multi-Harness Cable (EAD63886215) and field-supplied wiring. The cables are separate purchases.

NOTICE

When using field-supplied wiring, make sure to connect the yellow to yellow communications wire, red to red (12V power wire), and black to black (ground wire) terminals on the remote controller.

Figure 47: PZCWRC1 LG Wired Remote Extension Cable.



Figure 48: EAD63886215 LG Multi-Harness Cable.



Figure 49: Example of Wired Controller Terminals.

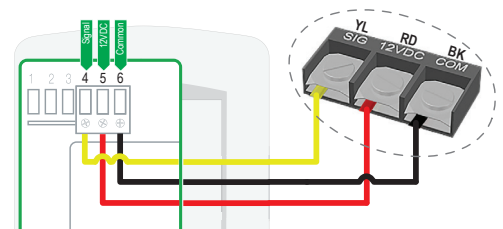

CONTROLLERS

Wired Controller Placement

Wired controllers include a sensor to detect room temperature. To maintain comfort levels in the conditioned space, the wired controller must be installed in a location away from direct sunlight, high humidity, and where it could be directly exposed to cold air. Controller must be installed four (4) to five (5) feet above the floor where its LED display can be read easily, in an area with good air circulation, and where it can detect an average room temperature.

⊘ Do not install the wired controller near or in:

- Drafts or dead spots behind doors and in corners.
- Hot or cold air from ducts.
- Radiant heat from the sun or appliances.
- Concealed pipes and chimneys.
- An area where temperatures are uncontrolled, such as an outside wall.

Figure 50: Proper Location for the Wired Controller.

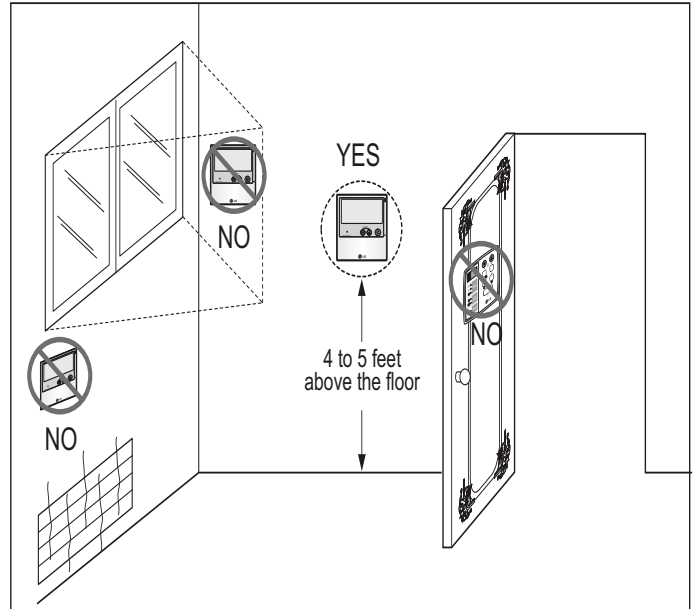

Assigning the Thermistor for Temperature Detection

Each indoor unit includes a return air thermistor assigned to sense the temperature. If a wired controller is installed, there is a choice of sensing temperature with either the indoor unit return air thermistor or the thermistor in the wired controller. It is also an option to set both thermistors to sense temperature so that indoor unit bases its operation on the first thermistor to reach the designated temperature differential. For applicable indoor units, an optional Remote Temperature Sensor can be used in lieu of the return air thermistor—either alone or in conjunction with a wired controller thermistor as previously described.

LIMITED WARRANTY (USA)

The product's full Limited Warranty terms and conditions and arbitration requirements are available at <https://www.lghvac.com>.

Inverter



LG Electronics, U.S.A., Inc.
Air Conditioning Technologies
4300 North Point Parkway
Alpharetta, Georgia 30022
www.lghvac.com

EM_SZ_Extended_Piping_R32_05_25
Supersedes: EM_SZ_Extended_Piping_R32_01_25
EM_SZ_Extended_Piping_R32_12_24