

### Features

- Contemporary styling
- Right-side lever handle
- 8-5/8" (219 mm) spout height
- 4-15/16" (125 mm) spout reach
- Faucet spout rotates 360° and offers clearance for filling glasses and pitchers
- 1.5 gpm (5.7 lpm) maximum flow rate at 60 psi (4.14 bar)
- RO (reverse osmosis) compatible
- Works with KOHLER filtration systems or as a cold water tap
- KOHLER ceramic disc valves exceed industry longevity standards for a lifetime of durable performance

### Material

- Zinc construction
- KOHLER finishes resist corrosion and tarnishing

### Installation

- Single-hole installation

### Included Components

1329347 Air gap device

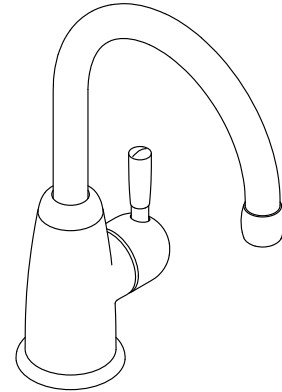

ADA

CSA B651

### Codes/Standards

ASME A112.18.1/CSA B125.1

NSF/ANSI/CAN 61

NSF/ANSI/CAN 372

All applicable US Federal and State material regulations

DOE - Energy Policy Act 1992

California Energy Commission (CEC)

ADA

ICC/ANSI A117.1







CSA B651

### KOHLER® Faucet Lifetime Limited Warranty

See website for detailed warranty information.

### Available Colors/Finishes

*Color tiles intended for reference only.*

Color	Code	Description
	CP	Polished Chrome
	SN	Vibrant™ Polished Nickel
	BN	Vibrant™ Brushed Nickel
	VS	Vibrant™ Stainless
	BL	Matte Black
	2MB	Vibrant™ Brushed Moderne Brass

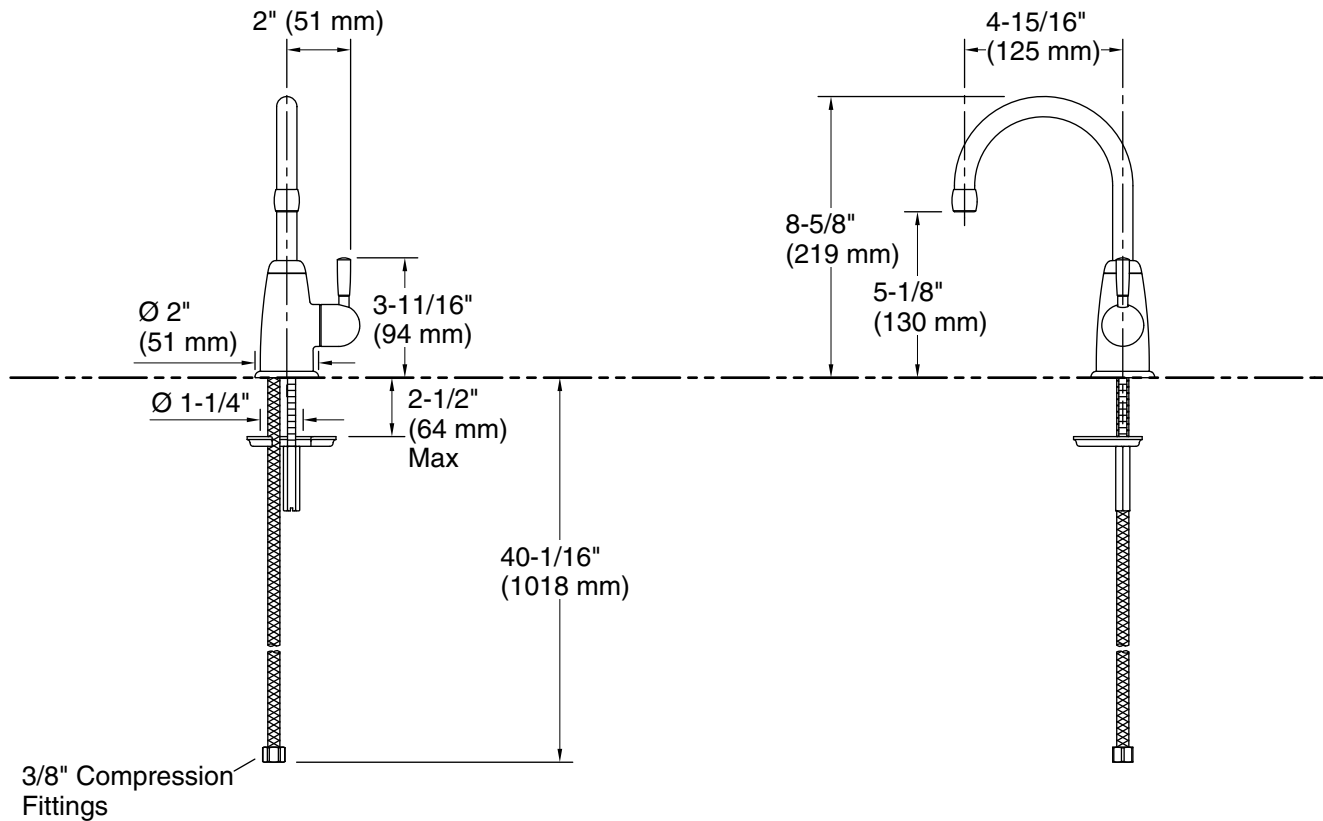

### Technical Information

All product dimensions are nominal.

### Notes

Install this product according to the installation instructions.

ADA, CSA B651 compliant when installed to the specific requirements of these regulations.