

Features

- Dual-control wall-mounted
- Cross handles
- Stationary spout
- Less drain
- 9" (229 mm) 90° spout from wall to center of drain
- 1.2 gpm (4.5 lpm) maximum flow rate at 60 psi (4.14 bar)

Material

- Brass

Required Products/Accessories

K-410-K Wall-mount Valve

Recommended Products/Accessories

K-23726 Drain treatment
K-23723 Faucet cleaner
K-14375 24" Double Towel Bar
K-14377 Pivoting toilet paper holder
K-14435 18" Towel Bar
K-14436 24" Towel Bar
K-14441 Towel Ring
K-14443 Robe Hook
K-14444 Vertical toilet paper holder

Optional Products/Accessories

K-7107 Decorative Drain
K-7108 Decorative Drain
K-7114 Pop-Up Drain
K-7124 Pop-Up Clicker Drain
K-7127 Drain
K-7129 Drain

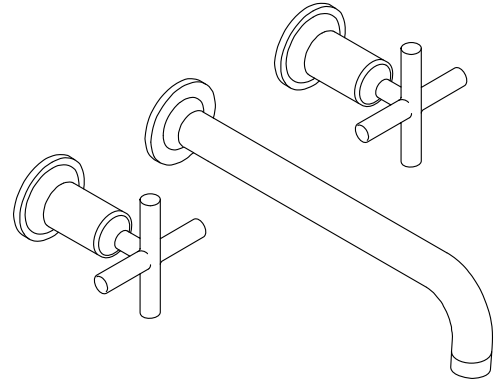

ADA



Codes/Standards







ASME A112.18.1/CSA B125.1
NSF/ANSI/CAN 61
NSF/ANSI/CAN 372
All applicable US Federal and State material regulations
DOE - Energy Policy Act 1992
EPA WaterSense™
California Energy Commission (CEC)
ADA
ICC/ANSI A117.1

KOHLER® Faucet Lifetime Limited Warranty

See website for detailed warranty information.

Available Colors/Finishes

Color tiles intended for reference only.

Color	Code	Description
	CP	Polished Chrome
	SN	Vibrant™ Polished Nickel
	AF	Vibrant™ French Gold
	BN	Vibrant™ Brushed Nickel
	BV	Vibrant™ Brushed Bronze
	BL	Matte Black

