



Verticyl® | K-2882

19-3/4" rectangular undermount bathroom sink







Features

- Geometric rectangular basin with vertical sides
- Overflow drain
- No faucet holes; requires wall- or counter-mount faucet



Available Colors/Finishes

Color tiles intended for reference only.

- | | | |
|---|----|-------------|
|  | 0 | White |
|  | 96 | Biscuit |
|  | NY | Dune |
|  | 95 | Ice Grey |
|  | 7 | Black Black |
|  | 17 | Teal |
|  | 42 | Aspen Green |



1-800-4KOHLER (1-800-456-4537)
Kohler Co. reserves the right to make revisions without notice to product specifications.
For the most current specification sheet, go to www.kohler.com USA or www.kohler.ca Canada.
4-22-2026 11:0 - US-CA

THE BOLD LOOK
OF **KOHLER**®

Codes/Standards

ADA compliant when installed to the specific requirements of these regulations.

ADA

ASME A112.19.2/CSA B45.1

ADA

ICC/ANSI A117.1

Technical Information

With Overflow:	Yes
Drain Hole Diameter:	1-3/4" (44 mm)
Basin Configuration:	Single Bowl
Basin Length:	17-1/4" (438 mm)
Basin Width:	13" (330 mm)
Basin Depth:	5-1/4" (134 mm)

Material

- Vitreous china
-

Recommended Products/Accessories

K-23726 Drain treatment

K-8998 Adjustable P-trap with tubing outlet, 1-1/4" x 1-1/4"

K-23725 Cast iron cleaner

Warranty

See website for detailed warranty information.

KOHLER® Vitreous China Bathroom Sink Lifetime Limited Warranty



1-800-4KOHLER (1-800-456-4537)

Kohler Co. reserves the right to make revisions without notice to product specifications.

For the most current specification sheet, go to www.kohler.com USA or www.kohler.ca Canada.

4-22-2026 11:0 - US-CA

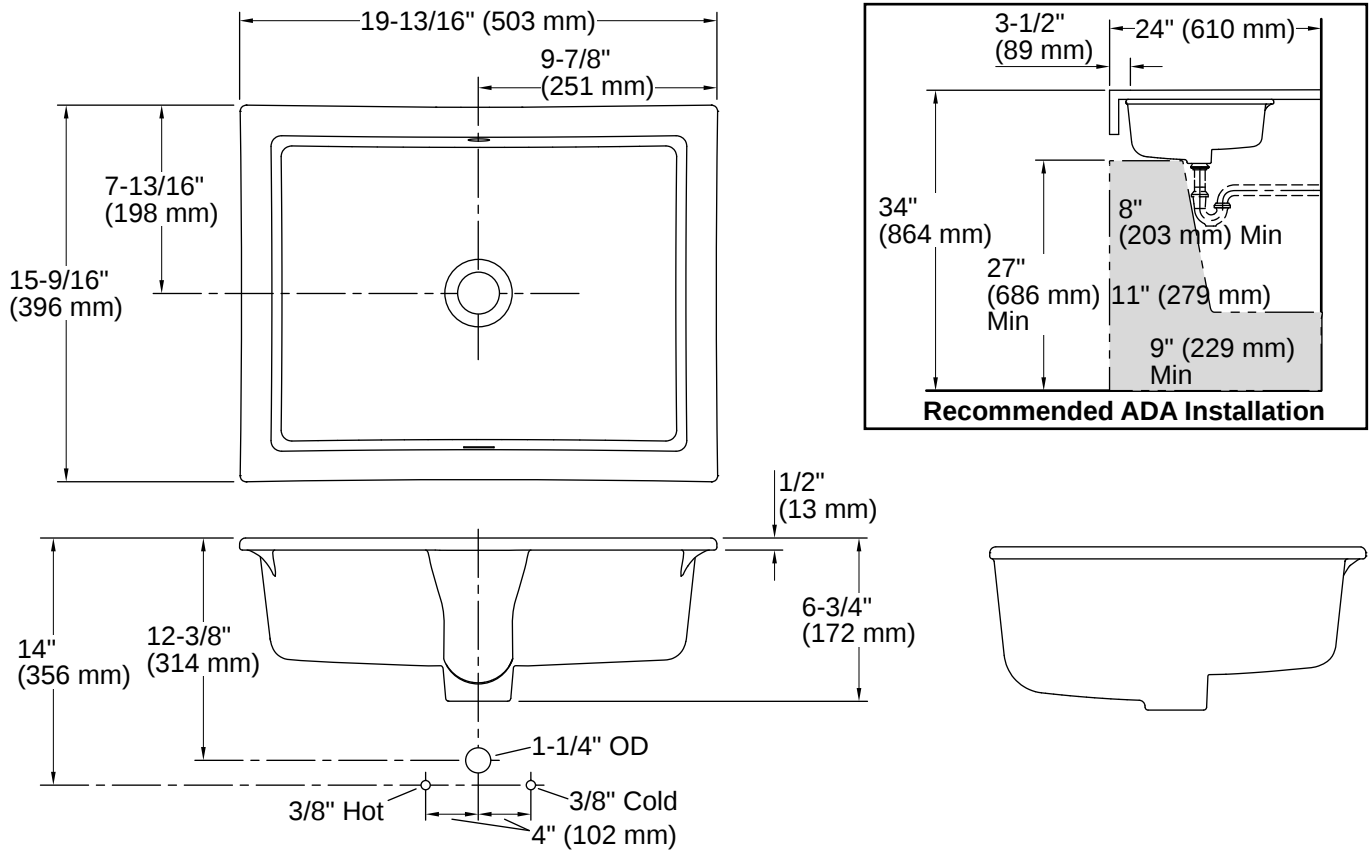

Installation

- Undermount

Installation Notes

Install this product according to the installation instructions.

NOTICE: Countertop manufacturer or cutter must use the current product template available at www.kohler.com, or by calling 1-800-4KOHLER. Kohler Co. is not responsible for cutout errors when the incorrect cutout template is used.

Product dimensions are nominal and may vary per ASME A112.19.2 tolerances.

ADA compliant when installed to the specific requirements of these regulations.

