

### Features

- Arm features 5#" reach
- 1/2" NPT connection

### Material

- Durable metal construction
- KOHLER finishes resist corrosion and tarnishing

### Installation

- Wall-mount



### Codes/Standards









ASME A112.18.1/CSA B125.1

### KOHLER® One-Year Limited Warranty

See website for detailed warranty information.

### Available Colors/Finishes

*Color tiles intended for reference only.*

Color	Code	Description
	CP	Polished Chrome
	SN	Vibrant™ Polished Nickel
	AF	Vibrant™ French Gold
	PB	Vibrant™ Polished Brass
	BN	Vibrant™ Brushed Nickel
	BV	Vibrant™ Brushed Bronze
	2BZ	Oil-Rubbed Bronze
	BL	Matte Black
	2MB	Vibrant™ Brushed Moderne Brass

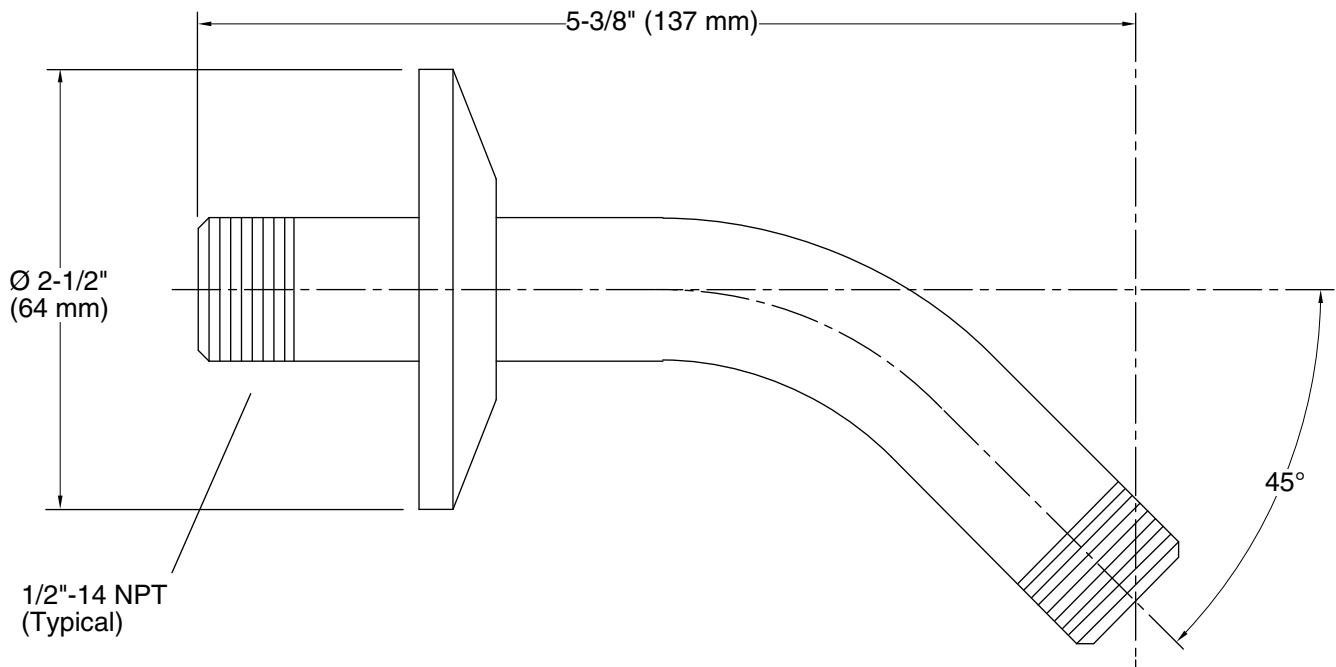

**Technical Information**

All product dimensions are nominal.