

Features

- Single-function rainhead
- MasterClean™ sprayface features an easy-to-clean surface that withstands mineral buildup
- Optimized sprayface for maximum performance
- 1.75 gpm (6.6 lpm) maximum flow rate

Material

- Solid-brass construction for durability and reliability

Technology

- Katalyst™ air-induction technology infuses water with air, creating bigger drops for a more powerful spray

Installation

- 1/2 -14 NPT connection
- Ceiling-mount



Codes/Standards









ASME A112.18.1/CSA B125.1
DOE - Energy Policy Act 1992
EPA WaterSense™
California Energy Commission (CEC)

KOHLER® Faucet Lifetime Limited Warranty

See website for detailed warranty information.

Available Colors/Finishes

Color tiles intended for reference only.

Color	Code	Description
	CP	Polished Chrome
	SN	Vibrant™ Polished Nickel
	BGD	Vibrant™ Moderne Brushed Gold
	BN	Vibrant™ Brushed Nickel
	BV	Vibrant™ Brushed Bronze
	BL	Matte Black
	2MB	Vibrant™ Brushed Moderne Brass
	RGD	Vibrant Rose Gold
	TT	Vibrant Titanium

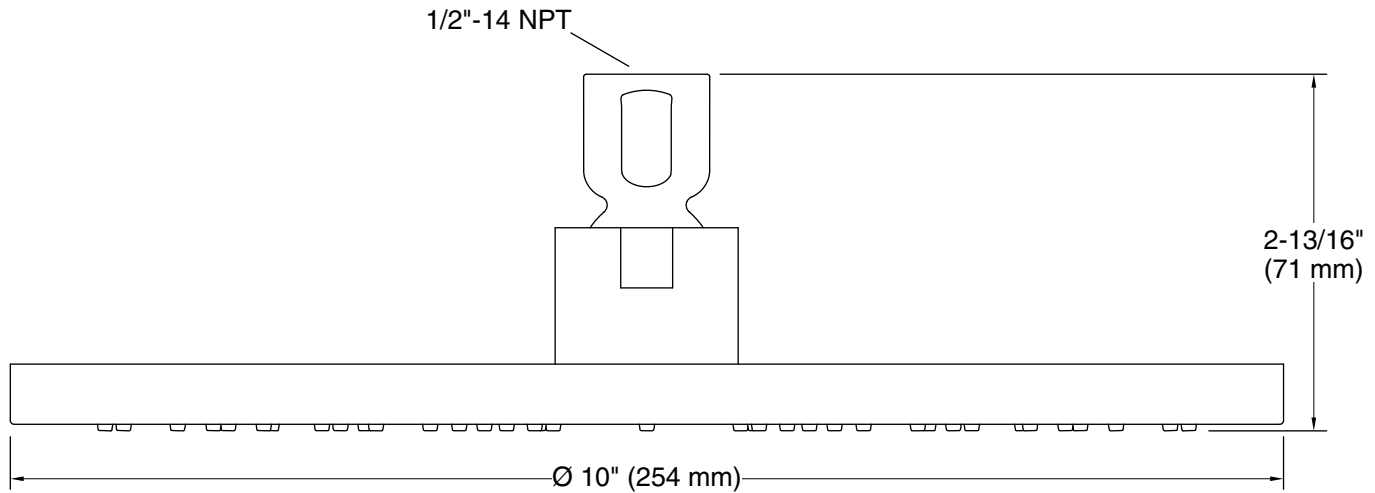

Technical Information

All product dimensions are nominal.

Showerhead/Body Spray:

Rated maximum flow: 1.75 gal/min (6.6 l/min)

Pressure: 80 psi (5.5 bar)

Notes

For use with automatic compensating valves rated at 1.4 gal/min (5.3 l/min) or less.

Install this product according to the installation instructions.