

Features

- Single-function rainhead
- MasterClean™ sprayface features an easy-to-clean surface that withstands mineral buildup and maximizes spray performance
- Optimized sprayface for maximum performance
- 2.5 gpm (9.5 lpm) maximum flow rate

Material

- Solid-brass construction for durability and reliability

Technology

- Katalyst® air-induction technology infuses water with air, creating bigger drops for a more powerful spray

Installation

- 1/2" -14 NPT connection



Codes/Standards











ASME A112.18.1/CSA B125.1
DOE - Energy Policy Act 1992
NOM Standards
NOM 008-CONAGUA

KOHLER® Faucet Lifetime Limited Warranty

See website for detailed warranty information.

Available Colors/Finishes

Color tiles intended for reference only.

Color	Code	Description
	CP	Polished Chrome
	SN	Vibrant® Polished Nickel
	AF	Vibrant® French Gold
	BN	Vibrant® Brushed Nickel
	BV	Vibrant® Brushed Bronze
	BL	Matte Black
	2MB	Vibrant® Brushed Moderne Brass
	TT	Vibrant Titanium
	BGP	Vibrant Brushed Graphite
	DR	Deep Bronze

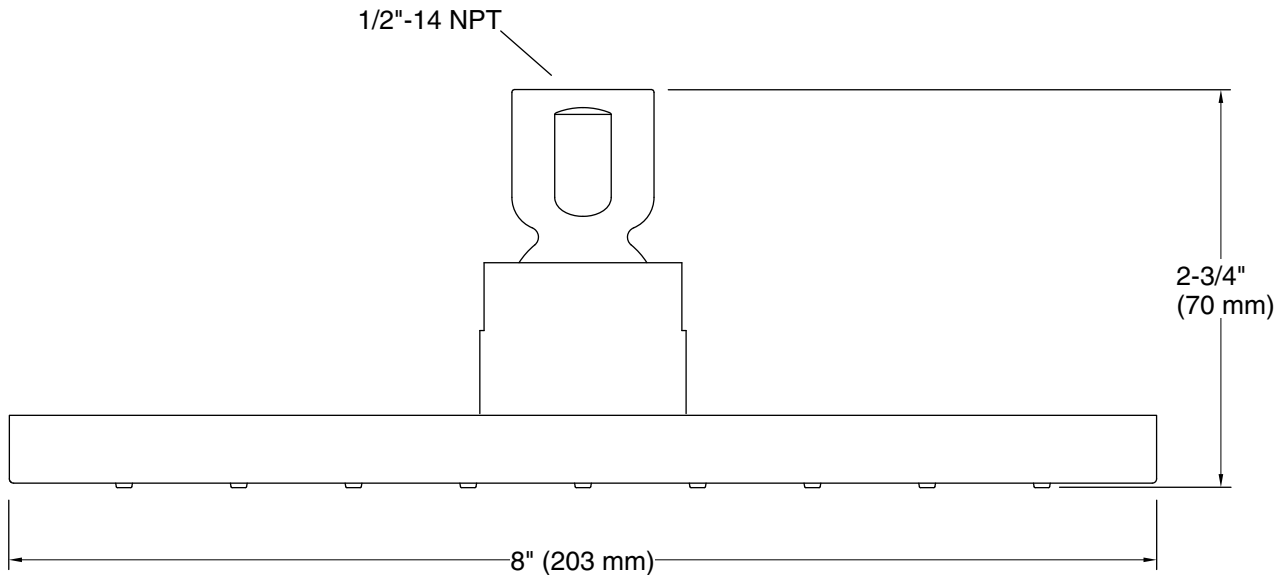

Technical Information

All product dimensions are nominal.

Spout:

Shower/Rainhead rated max flow: 2.5 gal/min (9.5 l/min)

Notes

Install this product according to the installation instructions.