

Features

- A single handle controls both on/off activation and temperature setting.
- 5" (127 mm) spout reach.
- 1.2 gpm (4.5 lpm) maximum flow rate at 60 psi (4.14 bar).
- KOHLER ceramic disc valves exceed industry longevity standards for a lifetime of durable performance.
- Clicker drain with tailpiece and overflow.
- Coordinates with other products in the Riff collection.

Material

- Premium metal construction for durability and reliability.
- KOHLER finishes resist corrosion and tarnishing.

Installation

- Deck-mount.
- Single hole.
- Flexible supply lines and quick-connect fittings simplify installation.

Recommended Products/Accessories

- K-27409 18" towel bar
- K-27410 24" towel bar
- K-27411 Double robe hook
- K-27412 Towel ring
- K-27413 Pivoting toilet paper holder

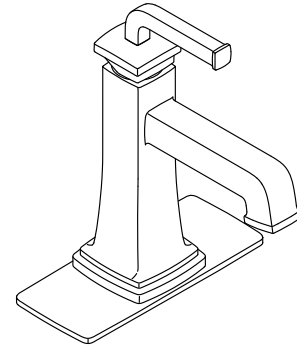

Codes/Standards





ASME A112.18.1/CSA B125.1
NSF/ANSI 61
NSF/ANSI 372
All applicable US Federal and State material regulations
DOE - Energy Policy Act 1992
EPA WaterSense®
California Energy Commission (CEC)
ADA
ICC/ANSI A117.1
CSA B651
OBC

KOHLER® Faucet Lifetime Limited Warranty

See website for detailed warranty information.

Available Colors/Finishes

Color tiles intended for reference only.

| Color | Code | Description |
|---|------|--------------------------------|
|  | CP | Polished Chrome |
|  | SN | Vibrant® Polished Nickel |
|  | BN | Vibrant® Brushed Nickel |
|  | BL | Matte Black |
|  | 2MB | Vibrant® Brushed Moderne Brass |

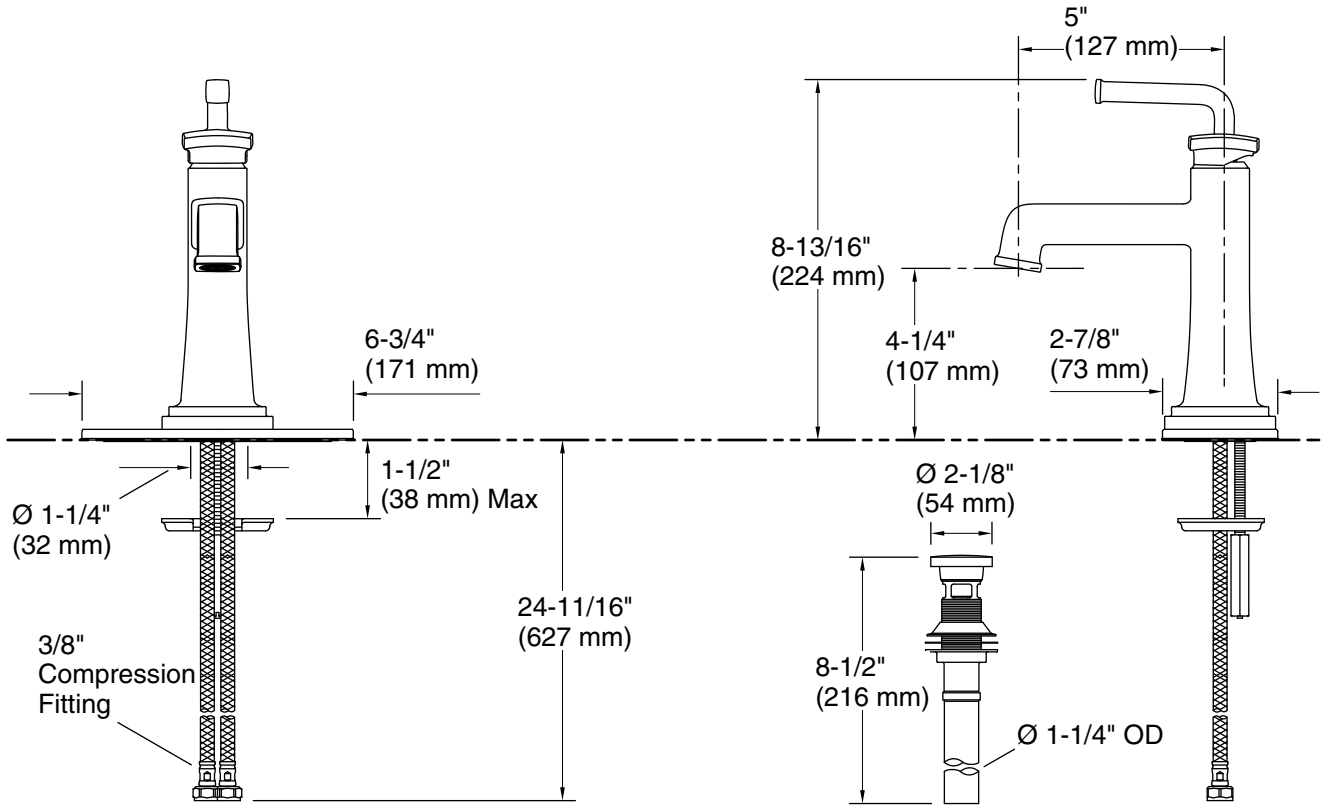

Technical Information

All product dimensions are nominal.

Faucet:

Flow rate: 1.2 gal/min (4.5 l/min)
 Pressure: 60 psi (4.1 bar)
 Drain included: Yes

Notes

Install this product according to the installation instructions.

ADA, OBC, CSA B651 compliant when installed to the specific requirements of these regulations.