

### Features

- 1.6 gpf (6.0 lpf)
- Left-hand Polished Chrome trip lever
- Combines with the K-31588 or K-31589 bowl to create a complete K-31620 or K-31640 Cimarron™ toilet

### Technology

- AquaPiston™ canister optimizes the flow out of the tank, harnessing gravity and the natural powerful reducing cascade of water to increase the power and effectiveness of the flush
- Easy-to-flush canister design requires less force to actuate than a 3" (76 mm) flapper, and has 90% less exposed seal material which resists conditions that cause wear, tear, shrinkage and swelling

### Recommended Products/Accessories

- K-31588 Elongated toilet bowl
- K-31589 Round-front toilet bowl
- K-25986-L Left-hand trip lever



### Codes/Standards





ASME A112.19.2/CSA B45.1

### KOHLER® One-Year Limited Warranty

See website for detailed warranty information.

### Available Colors/Finishes

*Color tiles intended for reference only.*

Color	Code	Description
	0	White
	96	Biscuit
	95	Ice™ Grey
	7	Black Black™

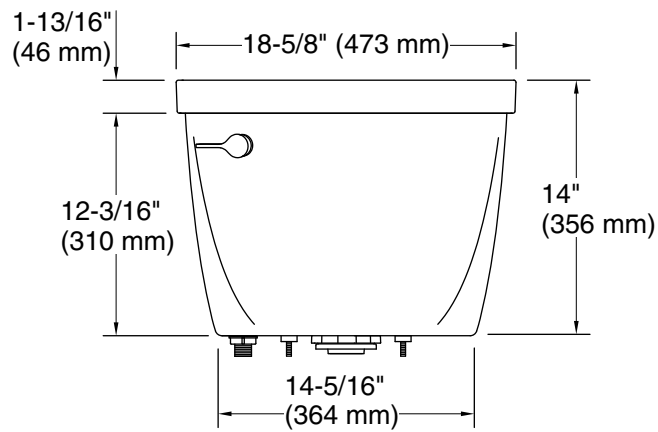
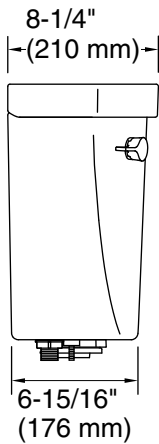
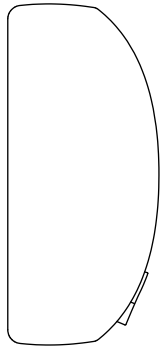

## Technical Information

All product dimensions are nominal.

Toilet type: Bowl-mount  
Flush type: AquaPiston  
Rough-in: 12" (305 mm)

## Notes

Install this product according to the installation instructions.