

Features

- Frameless design emphasizes glass and creates a sleek, minimalist look.
- Innovative roller design with stainless steel bearings simplifies installation and provides out-of-plumb adjustability while glass is installed.
- 17" (432 mm) vertical handles with 1/4" (6 mm) inside knob for easy opening and closing.
- Cushioned center guide provides smooth, quiet sliding action.
- CleanCoat®+ glass coating creates a hydrophobic barrier that repels water, soap scum, and residue, saving time and protecting shower doors 10 times longer than original CleanCoat. (Based on 2021 internal wear/abrasion testing using a microfiber cloth.)
- Smooth, easy-to-clean wall jambs.
- Tempered glass ensures enhanced safety and durability.

Material

- Frameless, 5/16" (8mm) thick Crystal Clear tempered glass.
- Anodized aluminum prevents rust and corrosion.

Installation

- Fits opening widths 44-5/8" – 47-5/8" (1134 – 1210 mm).
- 77-9/16" (1970 mm) high, with 71-9/16" (1818 mm) minimum head clearance.
- 3" (76.2 mm) width adjustment.
- Out-of-plumb adjustability simplifies installation.
- For residential use only.
- Not for use in hospitality.

Recommended Products/Accessories

K-23723 Faucet cleaner

Included Components

Additional Components:

Hardware kit



Codes/Standards

ANSI Z97.1

CPSC 16CFR 1201

KOHLER® One-Year Limited Warranty

See website for detailed warranty information.

Available Glass Options

Code	Description
L	Crystal Clear

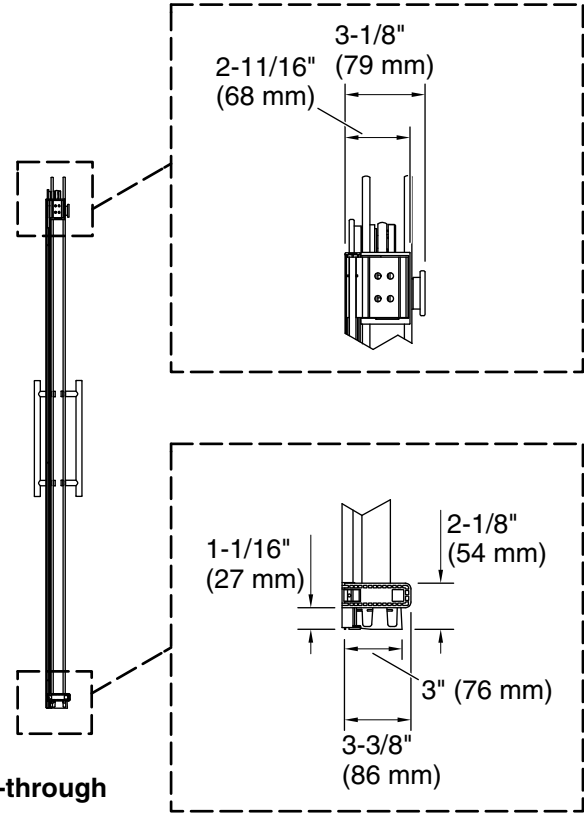
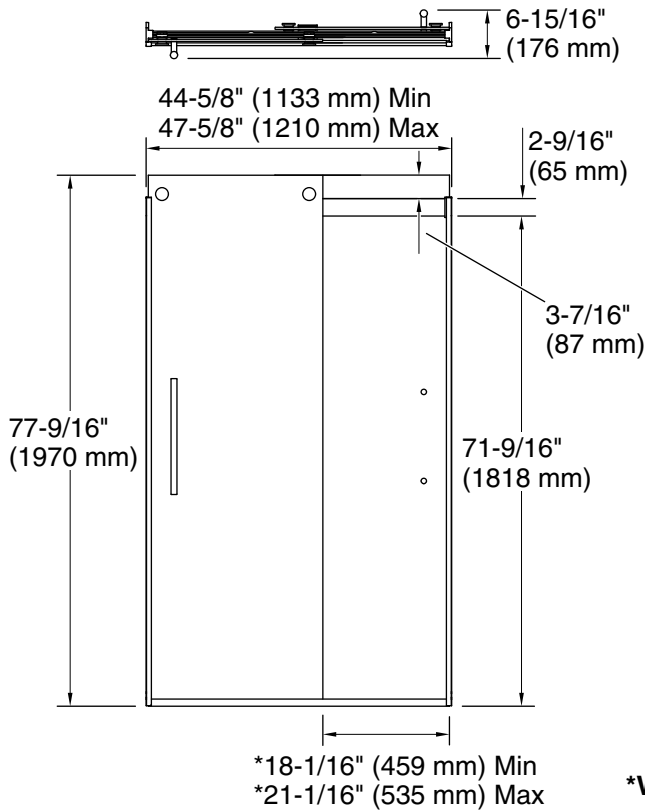

Technical Information

All product dimensions are nominal.

Installation type:	For shower base installation
Opening Width - Min:	44-5/8" (1133 mm)
Opening Width - Max:	47-5/8" (1210 mm)
Walk-through - Min:	18-1/16" (459 mm)
Walk-through - Max:	21-1/16" (535 mm)
Base-To-Wall Radius - Max:	1/2" (13 mm)
Glass thickness:	5/16" (8 mm)
Glass coating:	CleanCoat+

Notes

Install this product according to the installation instructions.

The vertical opening should be a minimum of 80-1/2" (2045 mm) to allow for installation clearance.