

Features

- 21" (533 mm) minimum base cabinet width
- Single round bowl
- 8" (203 mm) depth

Material

- KOHLER® enameled cast iron

Installation

- Top-mount or undermount

Recommended Products/Accessories

- K-8801 Sink drain and strainer with tailpiece
- K-8799 Sink drain and strainer basket
- K-23726 Drain treatment
- K-23725 Cast iron cleaner

Optional Products/Accessories

- K-11352 Disposal Flange with Stopper

Included Components

- 52047 Clamp Accessory Pack, 4 Ea.



ADA

Codes/Standards











ASME A112.19.1/CSA B45.2
ADA
ICC/ANSI A117.1
IAPMO Certification

KOHLER® Enameled Cast Iron Kitchen and Bathroom Sink Lifetime Limited Warranty

See website for detailed warranty information.

Available Colors/Finishes

Color tiles intended for reference only.

Color	Code	Description
	0	White
	FF	Sea Salt™
	96	Biscuit
	NY	Dune
	95	Ice™ Grey
	58	Thunder™ Grey
	7	Black Black™
	TRF	Truffle
	42	Aspen Green
	34	Fresh Green

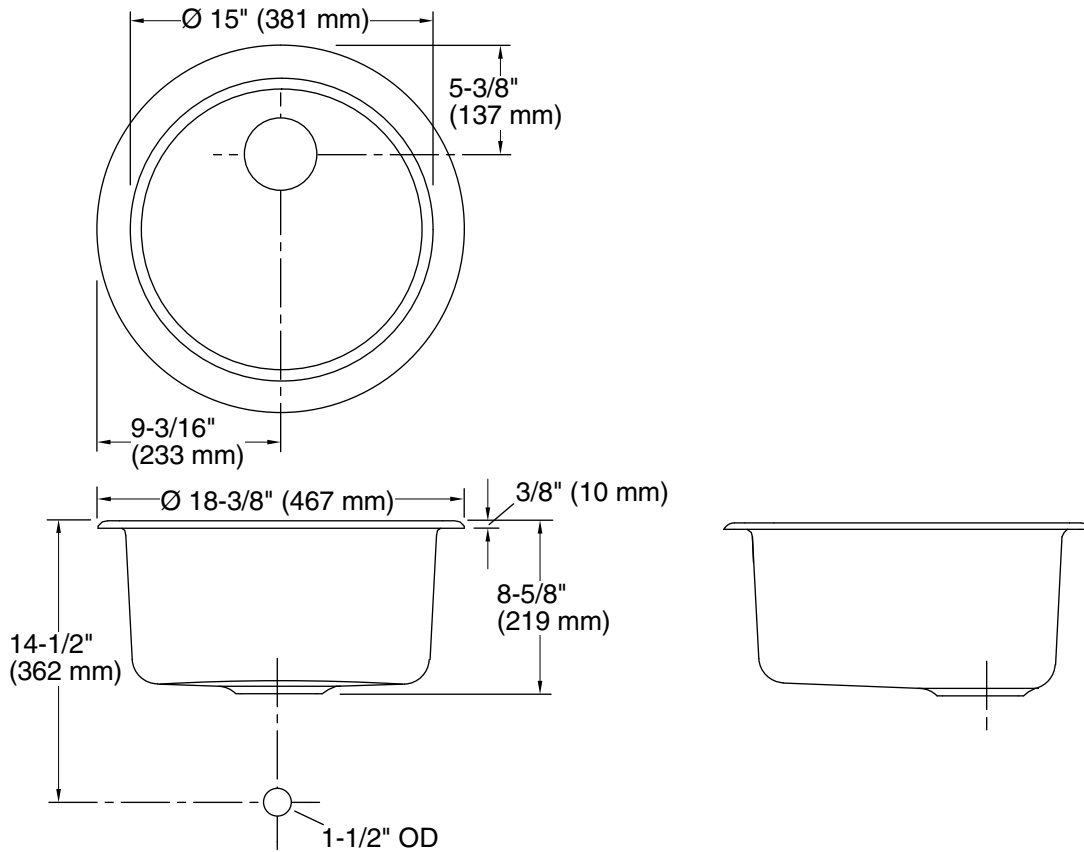

Technical Information

All product dimensions are nominal.

Bowl configuration:	Single
Min. base cabinet width:	21" (533 mm)
Bowl area (Only):	Length: 15" (381 mm) Width: 15" (381 mm) Bowl depth: 8" (203 mm)
Drain hole:	3-5/8" (92 mm)
Template:	112355-7, required, included

Notes

Install this product according to the installation instructions.

ADA compliant when installed to the specific requirements of these regulations.

ADA permits a parallel approach to wet bars.