



Embra™ by Studio McGee

One-light sconce
K-32252-SC01

Features

- Designed in collaboration with Studio McGee
- Globular glass shades extend from rods with flared metal detail in elegant transitional designs suited for any room
- Requires bulb with medium (E26) base; type A19 bulb recommended (sold separately)
- Suitable for damp locations, per UL 1598
- Includes installation hardware
- Coordinates with other products in the Embra collection

Material

- Premium metal and glass construction
- Manufactured with quality materials and complemented with a meticulous finishing process
- Durable finishes engineered to last and designed to coordinate with KOHLER faucet finishes



Codes/Standards

UL 1598
CSA C22.2 No. 250.0

KOHLER® Indoor Lighting Fixtures Limited Warranty

See website for detailed warranty information.

Available Colors/Finishes

Color tiles intended for reference only.

Color	Code	Description
	SNL	Polished Nickel
	BNL	Brushed Nickel
	CPL	Polished Chrome
	BLL	Matte Black
	2GL	Brushed Moderne Brass

1-800-4KOHLER (1-800-456-4537)

Kohler Co. reserves the right to make revisions without notice to product specifications.

For the most current Specification Sheet, go to www.kohler.com USA or www.kohler.ca Canada

6-17-2024 20:56 - US

THE BOLD LOOK
OF **KOHLER**®

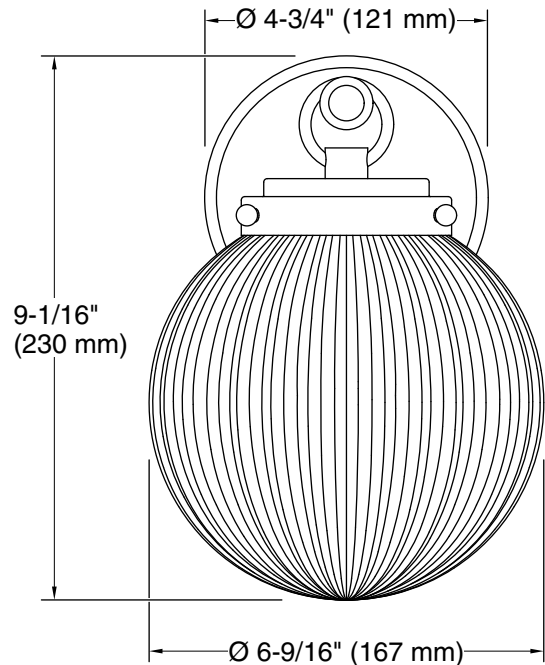
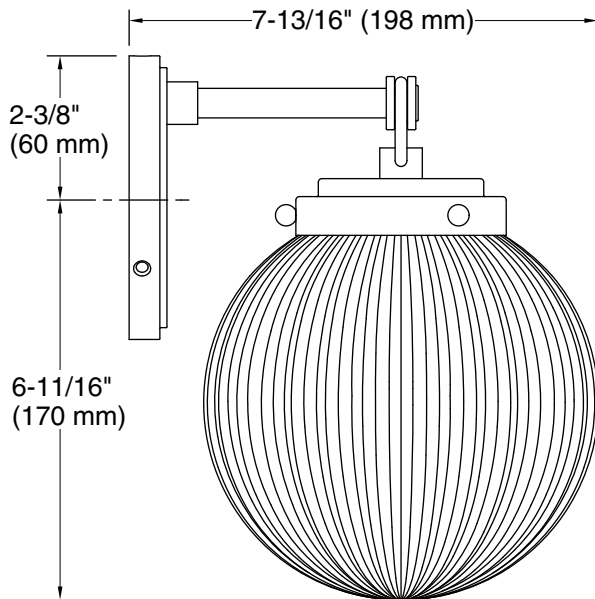

Required Electrical Service

One circuit required.

120 V, 0.333 A, 60 Hz

Technical Information

All product dimensions are nominal.

Material: Steel, Glass, Brass

Number of Lights: 1

Lighting Type: Socket-based

Socket Type: E-26 Medium

Number of Shades: 1

Shade Type: Clear Glass

Hanging Type: Non-hanging

Notes

Install this product according to the installation instructions.