

Features

- Dual-control wall-mounted.
- Cross handles.
- Stationary spout.
- Less drain.
- 6-3/4" (171 mm) Max 35° spout from wall to center of drain.
- 1.2 gpm (4.5 lpm) maximum flow rate at 60 psi (4.14 bar).

Material

- Brass.
- KOHLER finishes resist corrosion and tarnishing.

Required Products/Accessories

K-410-K Wall-mount Valve

Recommended Products/Accessories

K-23726 Drain treatment

K-23723 Faucet cleaner

Optional Products/Accessories

K-7107 Decorative Drain

K-7108 Decorative Drain

K-7114 Pop-Up Drain

K-7124 Pop-Up Clicker Drain

K-7129 Drain

K-7127 Drain



ADA



Codes/Standards

ASME A112.18.1/CSA B125.1

NSF/ANSI 61

NSF/ANSI 372

All applicable US Federal and State material regulations

DOE - Energy Policy Act 1992

EPA WaterSense®

California Energy Commission (CEC)

ADA







ICC/ANSI A117.1

KOHLER® Faucet Lifetime Limited Warranty

See website for detailed warranty information.

Available Colors/Finishes

Color tiles intended for reference only.

Color	Code	Description
	CP	Polished Chrome
	SN	Vibrant® Polished Nickel
	AF	Vibrant® French Gold
	BGD	Vibrant® Moderne Brushed Gold
	BN	Vibrant® Brushed Nickel
	BV	Vibrant® Brushed Bronze

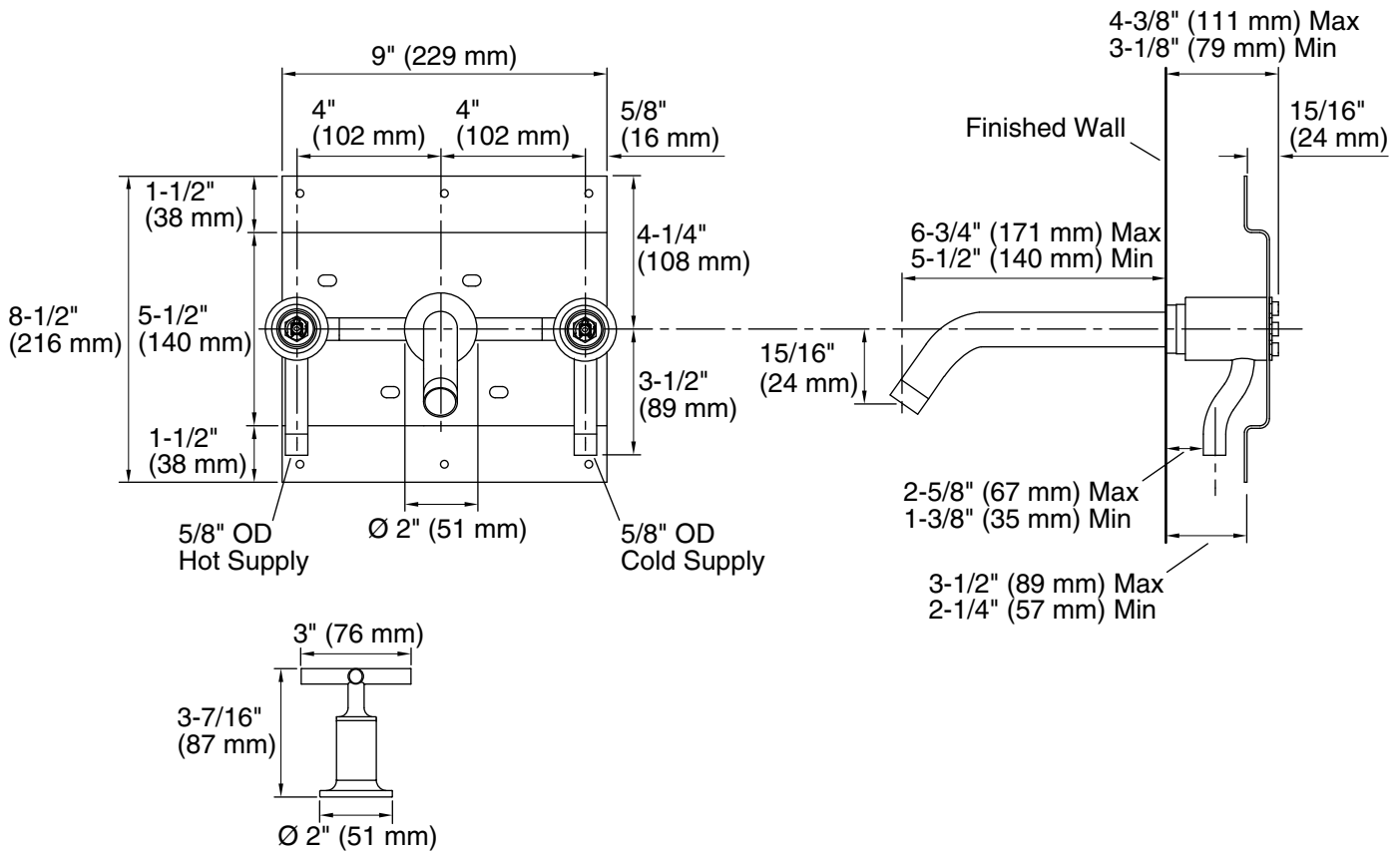

Technical Information

All product dimensions are nominal.

Faucet:

Flow rate: 1.2 gal/min (4.5 l/min)

Pressure: 60 psi (4.1 bar)

Spout:

Spout reach: 6-3/4" (171 mm)

Notes

Install this product according to the installation guide.

The distance between the bottom of spout and top of the fixture rim must not be less than 1-1/2" (38 mm) and not greater than 6" (152 mm).

Three 1-1/2" (38 mm) diameter cutout holes are required for spout and handles.

ADA compliant for handles only.

ADA compliant when installed to the specific requirements of these regulations.