

Features

- A single handle controls both on/off activation and temperature setting
- 7" (178 mm) spout height
- 1.2 gpm (4.5 lpm) maximum flow rate at 60 psi (4.14 bar)
- KOHLER® ceramic disc valves exceed industry longevity standards for a lifetime of durable performance
- Metal touch-activated drain with 1-1/4" tailpiece
- Ideal for vessel sink applications
- Part of the Occasion bathroom faucet and accessory collection

Material

- Premium metal construction for durability and reliability
- KOHLER finishes resist corrosion and tarnishing

Installation

- Single hole
- Preattached flexible supply lines simplify installation

Recommended Products/Accessories

- K-23726 Drain treatment
- K-27060 18" towel bar
- K-27061 24" towel bar
- K-27062 24" double towel bar
- K-27063 Towel ring
- K-27064 Vertical toilet paper holder
- K-27065 Pivoting toilet paper holder
- K-27069 Robe hook
- K-27128 Toilet paper holder with tray



Codes/Standards









- ASME A112.18.1/CSA B125.1
- NSF/ANSI/CAN 61
- NSF/ANSI/CAN 372
- DOE - Energy Policy Act 1992
- EPA WaterSense®
- California Energy Commission (CEC)

KOHLER® Faucet Lifetime Limited Warranty

See website for detailed warranty information.

Available Colors/Finishes

Color tiles intended for reference only.

Color	Code	Description
	CP	Polished Chrome
	SN	Vibrant® Polished Nickel
	AF	Vibrant® French Gold
	BN	Vibrant® Brushed Nickel
	BV	Vibrant® Brushed Bronze
	BL	Matte Black
	2MB	Vibrant® Brushed Moderne Brass
	BMB	Matte Black with Moderne Brass

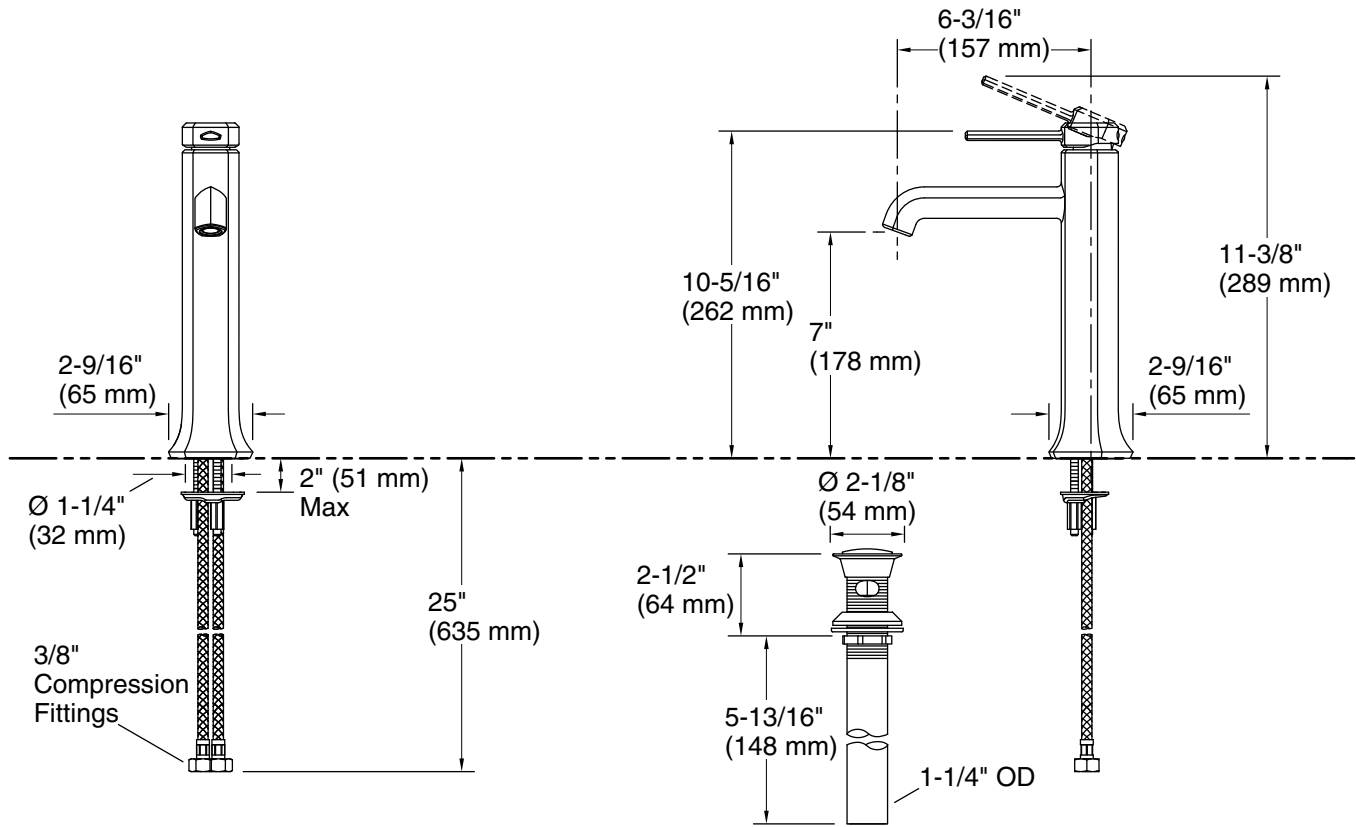

Technical Information

All product dimensions are nominal.

Faucet flow rate: 1.2 gal/min (4.5 l/min)

Drain included: Yes

Drain with overflow: Yes

Drain tailpiece included: Yes

Spout:

Spout reach: 6-3/16" (157 mm)