

PRODUCT SPECIFICATIONS

Elkay Quartz Luxe[®] 24-5/8" x 18-1/2" x 9-1/2" Single Bowl Undermount Sink. Proprietary manufacturing process that combines natural quartz with high performance UV-stable acrylic resins results in an impact resistant, nonporous and heat-, scratch-, stain- and fade-resistant surface. Naturally sound deadening and Rear Center drain placement.

Installation Type:	Undermount
Material:	Quartz
Finish:	Arctic Fox (FX), Caviar (CA), Charcoal (CH), Chestnut (CN), Jubilee (JB), Obsidian (DN), Parchment (PA), Ricotta (RT), Sandstone (SD), Silvermist (SM)
Number of Bowls:	1
Sink Dimensions:	24-5/8" x 18-1/2" x 9-1/2"
Bowl 1 Dimensions:	22-5/16" x 16-7/16" x 9-1/2"
Drain Size:	3-1/2" (89mm)
Drain Location:	Rear Center
Minimum Cabinet Size:	30"
Mounting Hardware:	Part # 54300404 included
Template Included:	Yes
Cutout Template #:	0000001437

Template is available for download at [elkay.com](#). CAD software will be required to open the template.

Special Note: Reserve Selection products are sold exclusively, in-store and online, through authorized wholesalers.



A Century of Tradition and Quality. For more than 100 years, Elkay has been making innovative products and providing exceptional customer care. We take pride in offering plumbing products that make life easier, inspire change and leave the world a better place.



Product Compliance: CSA B45.5/IAPMO Z124



Sinks are listed by IAPMO[®] as meeting the applicable requirements of the Uniform Plumbing Code[®], International Plumbing Code[®], and National Plumbing Code of Canada.

[Clean and Care Manual \(PDF\)](#)
[Installation Instructions \(PDF\) - 100005238](#)
[Warranty \(PDF\)](#)

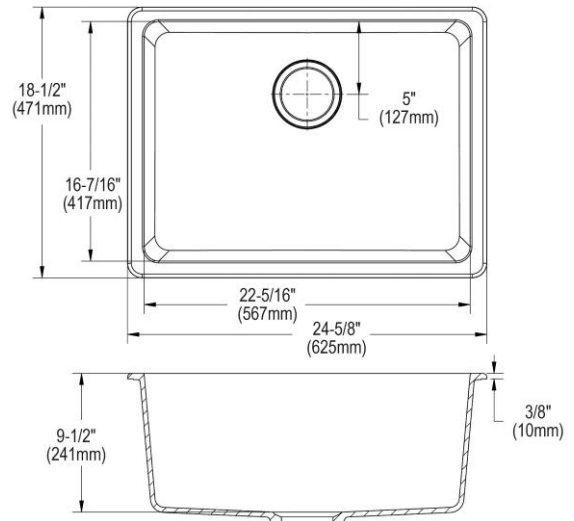







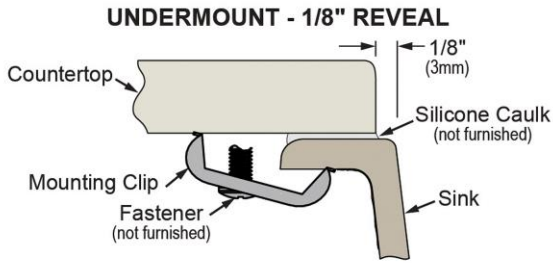

PART: _____ QTY: _____
 PROJECT: _____
 CONTACT: _____
 DATE: _____
 NOTES: _____
 APPROVAL: _____

In keeping with our policy of continuing product improvement, Elkay reserves the right to change product specifications without notice. Please visit [elkay.com](#) for the most current version of Elkay product specification sheets. This specification describes an Elkay product with design, quality, and functional benefits to the user. When making a comparison of other producers' offerings, be certain these features are not overlooked. Latest version of the spec sheet available: https://www.elkayfiles.com/spec-sheets/ELXU2522_spec.pdf

Installation Profile:



Designed to affix to the underside of any solid surface countertop.

Optional Accessories		
LKOBG2217SS	Elkay [®] Stainless Steel 19-13/16" x 13-13/16" x 1-1/4" Bottom Grid Spec Sheet (PDF)	
LKCBEG2217HW	Hardwood 23-1/4" x 17-3/8" x 1" Cutting Board Spec Sheet (PDF)	
LK99	Deluxe 3-1/2" Drain Type 304 Stainless Steel Body Strainer Basket Rubber Seal and Tailpiece Spec Sheet (PDF)	
LKQD35	Elkay [®] Polymer 3-1/2" Disposer Flange with Removable Basket Strainer and Rubber Stopper Spec Sheet (PDF)	
LKQS35	Elkay [®] Polymer 3-1/2" Drain Fitting with Removable Basket Strainer and Rubber Stopper Spec Sheet (PDF)	
LKEC2031	Elkay Explore Single Hole Kitchen Faucet with Pull-down Spray and Forward Only Lever Handle Spec Sheet (PDF)	
LK6000	Elkay Everyday Single Hole Deck Mount Kitchen Faucet with Pull-down Spray Forward Only Lever Handle Spec Sheet (PDF)	
LKQD35	Elkay [®] Polymer 3-1/2" Disposer Flange with Removable Basket Strainer and Rubber Stopper Spec Sheet (PDF)	

In keeping with our policy of continuing product improvement, Elkay reserves the right to change product specifications without notice. Please visit elkay.com for the most current version of Elkay product specification sheets. This specification describes an Elkay product with design, quality, and functional benefits to the user. When making a comparison of other producers' offerings, be certain these features are not overlooked. Latest version of the spec sheet available: https://www.elkayfiles.com/spec-sheets/ELXU2522_spec.pdf

LKQS35	Elkay [®] Polymer 3-1/2" Drain Fitting with Removable Basket Strainer and Rubber Stopper Spec Sheet (PDF)	
------------------------	---	---

In keeping with our policy of continuing product improvement, Elkay reserves the right to change product specifications without notice. Please visit elkay.com for the most current version of Elkay product specification sheets. This specification describes an Elkay product with design, quality, and functional benefits to the user. When making a comparison of other producers' offerings, be certain these features are not overlooked. Latest version of the spec sheet available: https://www.elkayfiles.com/spec-sheets/ELXU2522_spec.pdf