



Inia® Wading Pool®

Vessel bathroom sink
K-2773

Features

- Deep rectangular basin in translucent glass with rippled texture.
- Glass material provides a strong durable surface that is easy to clean yet visually distinctive.
- The Inia sink is available in clear glass (Ice), Translucent colors, and Opaque colors.

Material

- Glass.

Installation

- No faucet holes; requires wall- or counter-mount faucet.
- Vessel.

Recommended Products/Accessories

K-23726 Drain treatment

K-23723 Faucet cleaner

Included Components

Additional Components:

1197255



ADA

Codes/Standards

CSA B45.11/IAPMO Z401

ADA







ICC/ANSI A117.1

KOHLER® One-Year Limited Warranty

See website for detailed warranty information.

Available Colors/Finishes

Color tiles intended for reference only.

Color	Code	Description
	B11	Ice
	TG1	Translucent Dusk
	TG2	Translucent Dew
	TG3	Translucent Doe
	TG6	Translucent Sapphire
	TG7	Translucent Sandalwood
	TG8	Translucent Stone

1-800-4KOHLER (1-800-456-4537)

Kohler Co. reserves the right to make revisions without notice to product specifications.

For the most current Specification Sheet, go to www.kohler.com.

THE BOLD LOOK
OF **KOHLER**®

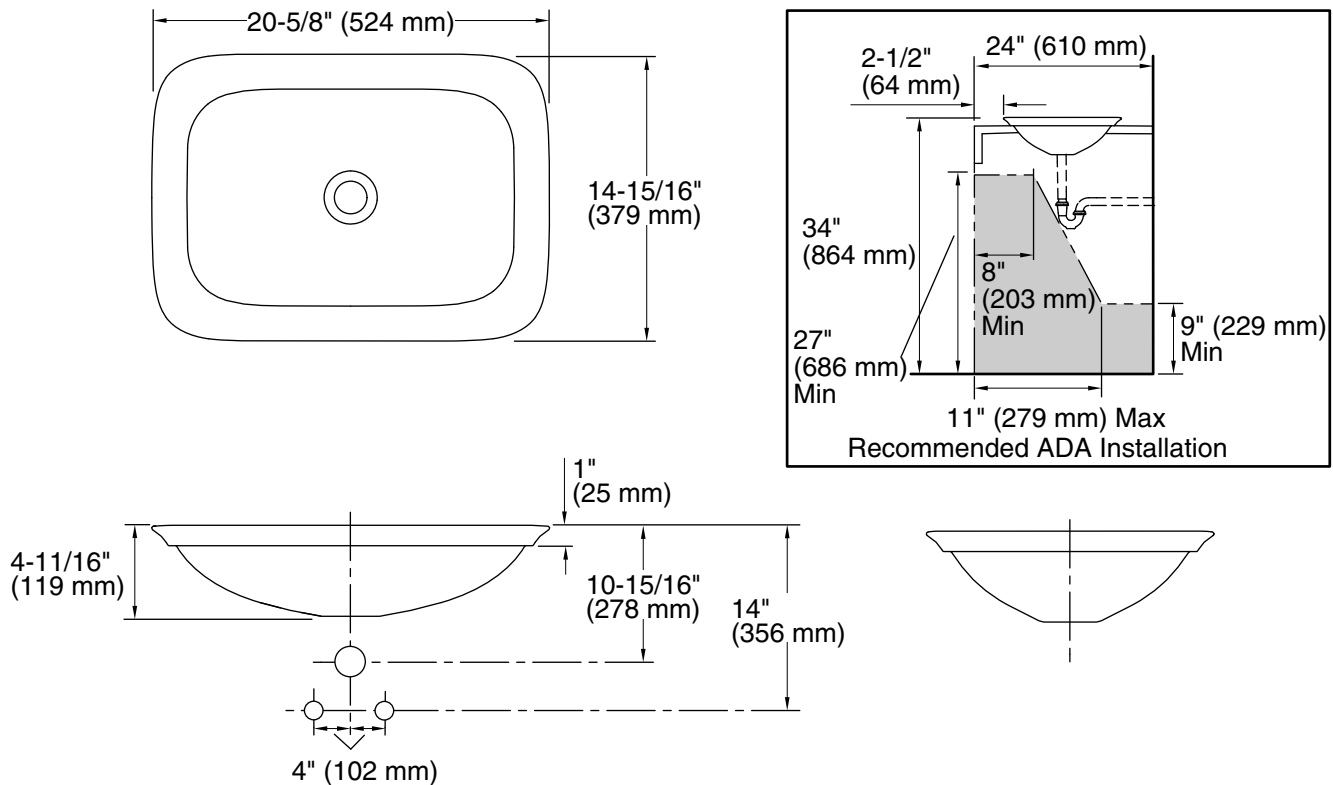

Technical Information

All product dimensions are nominal.

Installation: Vessel

Template: 1190263-7, not required, included

Notes

Install this product according to the installation instructions.

Product does not have an overflow.

NOTICE: Countertop manufacturer or cutter must use the cut-out template provided with the product, or a current one provided by Kohler Co. (call 1-800-4KOHLER). Kohler Co. is not responsible for cut-out errors when the incorrect cut-out template is used.

Product must be installed with the supplied drain gasket kit.

ADA compliant when installed to the specific requirements of these regulations.