



# Iron/Tones®

17" top-/undermount single-bowl bar sink  
**K-6584**

## Features

- 18" (457 mm) minimum base cabinet width
- Single bowl
- 7-1/2" (191 mm) depth

## Material

- KOHLER® enameled cast iron

## Installation

- Top-mount or undermount

## Recommended Products/Accessories

- K-5184 Stainless steel sink rack, 12-7/8" x 14-11/16"
- K-8801 Sink drain and strainer with tailpiece
- K-8799 Sink drain and strainer basket
- K-23726 Drain treatment
- K-23725 Cast iron cleaner

## Optional Products/Accessories

- K-3294 Hardwood cutting board for kitchen sinks
- K-11352 Disposal Flange with Stopper
- K-9000 P-Trap

## Included Components

- 52047 Clamp Accessory Pack, 4 Ea.



## Codes/Standards











- ASME A112.19.1/CSA B45.2
- IAPMO Certification

## KOHLER® Enameled Cast Iron Kitchen and Bathroom Sink Lifetime Limited Warranty

See website for detailed warranty information.

## Available Colors/Finishes

*Color tiles intended for reference only.*

Color	Code	Description
	0	White
	FF	Sea Salt™
	96	Biscuit
	NY	Dune
	95	Ice™ Grey
	58	Thunder™ Grey
	7	Black Black™
	TRF	Truffle
	17	Teal
	34	Fresh Green
	42	Aspen Green

1-800-4KOHLER (1-800-456-4537)

Kohler Co. reserves the right to make revisions without notice to product specifications.

For the most current Specification Sheet, go to [www.kohler.com](http://www.kohler.com) USA or [www.kohler.ca](http://www.kohler.ca) Canada

6-8-2024 20:46 - US

THE BOLD LOOK  
OF **KOHLER**®

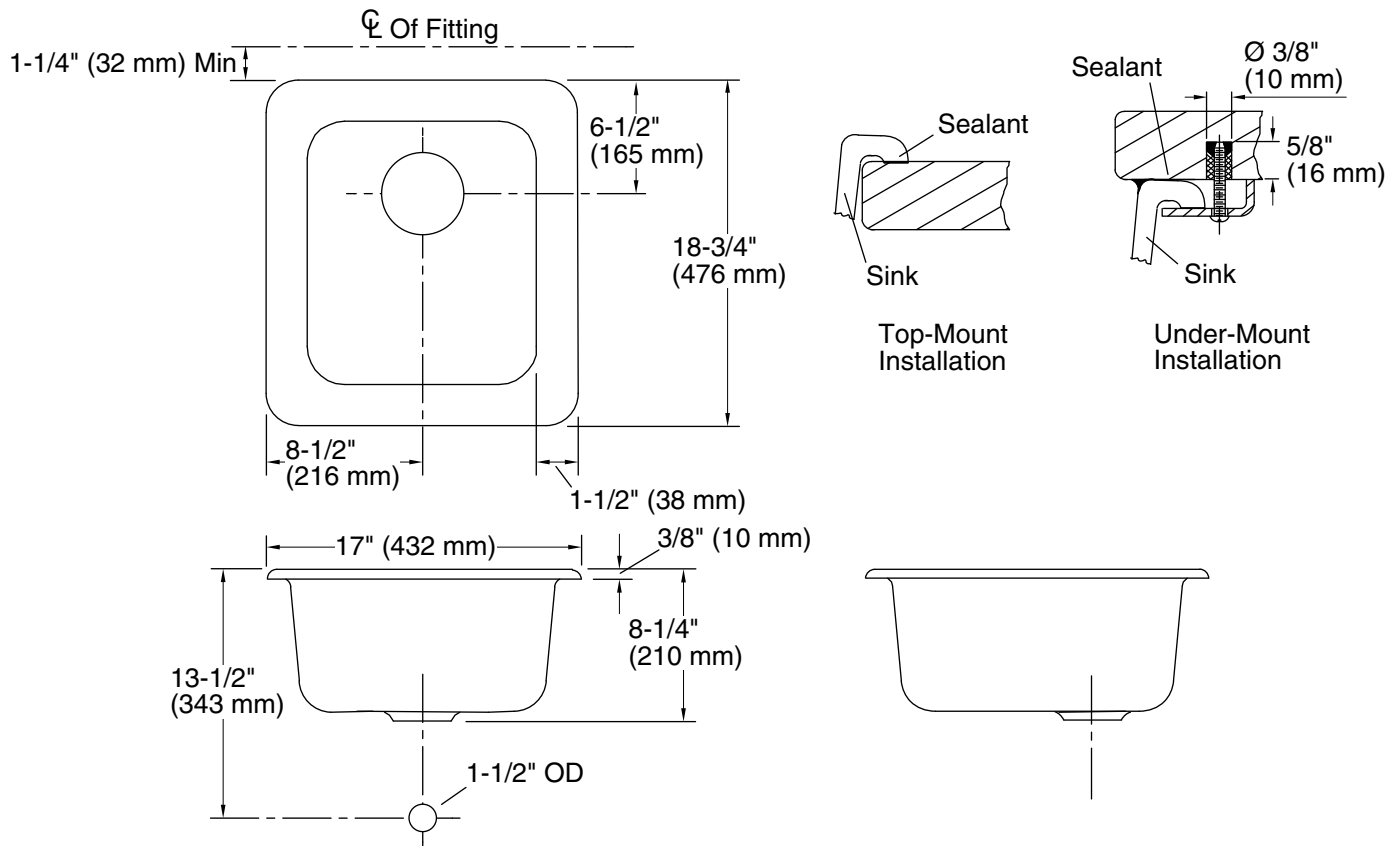

### Technical Information

All product dimensions are nominal.

Bowl configuration: Single

Min. base cabinet width: 18" (457 mm)

Bowl area: Length: 14" (356 mm)  
Width: 16" (406 mm)  
Bowl depth: 7-1/2" (191 mm)

Drain hole: 3-7/8" (98 mm)

Template: 114332-7, required, included

### Notes

Install this product according to the installation instructions.

Refer to install instructions included with fixture before beginning installation.

Supplied bowl clamp assemblies require 1" (25 mm) minimum countertop thickness. Installer must supply hardware for thinner countertops.

For multiple bowl under-mount installations, a minimum distance of 3-3/8" (86 mm) is required between bowls. Countertop supplier to determine required support.