



Cimarron®
1.6 gpf toilet tank
K-31614

Features

- 1.6 gpf (6.0 lpf).
- Left-hand Polished Chrome trip lever.
- Combines with the K-31588 or K-31589 bowl to create a complete K-31620 or K-31640 Cimarron® toilet.

Technology

- AquaPiston® canister optimizes the flow out of the tank, harnessing gravity and the natural powerful reducing cascade of water to increase the power and effectiveness of the flush.
- Easy-to-flush canister design requires less force to actuate than a 3" (76 mm) flapper, and has 90% less exposed seal material which resists conditions that cause wear, tear, shrinkage and swelling.

Recommended Products/Accessories

- K-31588 Elongated chair height toilet bowl
- K-31589 Round-front chair-height toilet bowl
- K-25986-L Left-hand trip lever



Codes/Standards





ASME A112.19.2/CSA B45.1

**KOHLER® One-Year Limited
Warranty**

See website for detailed warranty information.

Available Colors/Finishes

Color tiles intended for reference only.

Color	Code	Description
	0	White
	96	Biscuit
	95	Ice™ Grey
	7	Black Black™

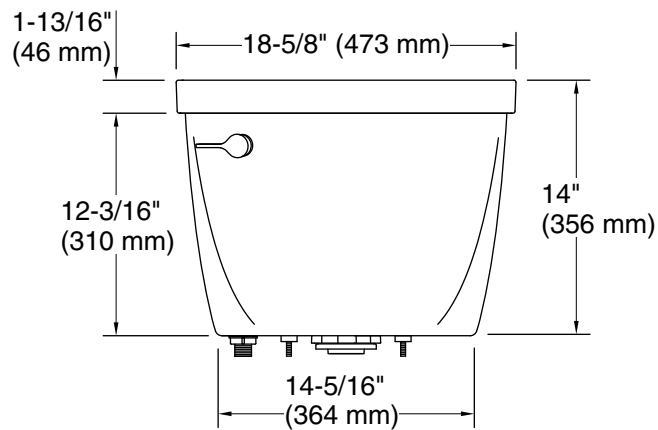
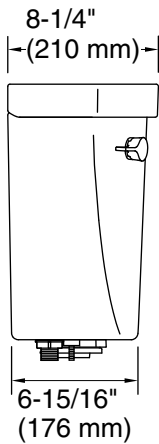
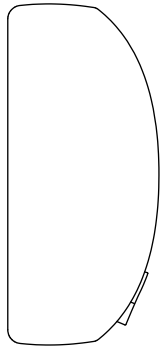

Technical Information

All product dimensions are nominal.

Toilet type: Bowl-mount
Flush type: AquaPiston®, Revolution 360®
Water Consumption
Full: 1.6 gpf (6 lpf)
Rough-in: 12" (305 mm)

Notes

Install this product according to the installation instructions.