

Installation and Operating Instructions

for use by heating contractor

VIESSMANN[®]

Vitoconnect Type OPT02

Communication interface for remote monitoring and remote control of heating systems over the internet, for the following user interfaces:

- ViCare app
- Vitoguide

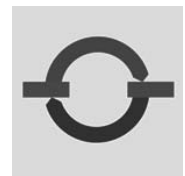

VITOCONNECT



Product may not be exactly as shown

IMPORTANT

**Read and save these instructions
for future reference.**

Safety Instructions

Please ensure that these instructions are read and understood before commencing installation. Failure to comply with the instructions listed below and details printed in this manual can cause product/property damage, severe personal injury, and/or loss of life. Ensure all requirements below are understood and fulfilled (including detailed information found in manual subsections).

■ **Product documentation**

Read all applicable documentation before commencing installation. Store documentation near boiler in a readily accessible location for reference in the future by service personnel.

► *For a listing of applicable literature, please see section entitled "Important Regulatory and Installation Requirements".*



■ **Warranty**

Information contained in this and related product documentation must be read and followed. Failure to do so renders the warranty null and void.



■ **Licensed professional heating contractor**

The installation, adjustment, service and maintenance of this equipment must be performed by a licensed professional heating contractor.

► *Please see section entitled "Important Regulatory and Installation Requirements".*



■ **Advice to owner**

Once the installation work is complete, the heating contractor must familiarize the system operator/ultimate owner with all equipment, as well as safety precautions/requirements, shutdown procedure, and the need for professional service annually before the heating season begins.



WARNING

Installers must follow local regulations with respect to installation of carbon monoxide detectors. Follow the Viessmann maintenance schedule of the boiler contained in this manual.

Operating and Service Documentation

It is recommended that all product documentation such as parts lists, operating and service instructions be handed over to the system user for storage. Documentation is to be stored near boiler in a readily accessible location for reference by service personnel.

Operational Safety

Vitoconnect facilitates communication over the Internet between the following components and the Viessmann server:

- Vitotronic control unit (Optolink interface)

The functionality is only available if the following conditions are met:

- The Vitoconnect is connected to the Internet via a Wi-Fi router.
- Internet access must be available at all times.
- The user has registered: see page 13.
- For messages to be sent even in case of a power failure, we recommend an uninterruptible power supply for the Vitoconnect and the Wi-Fi router.

Note:

- The heating system and the operability of the message channels must be checked at regular intervals.
- To further increase the reliability of the heating system, we recommend planning supplementary measures, e.g. frost protection or monitoring for water damage.

Liability

No liability is accepted for lost profit, missed savings, or other direct or indirect consequential damage that arises from the use of Vitoconnect, the Viessmann server or the software, as well as for damage from incorrect use.

In the event of any slightly negligent violation of substantial contractual obligations which are deemed essential for the purpose of complying with the subject matter of the contract, liability is limited to damage typical for the contract.

The limitation of liability is not applicable if the damages were caused deliberately or with gross negligence or if there is mandatory liability according to the law on product liability.

Viessmann's General Terms and Conditions of Sale of apply; the latest version of these terms and conditions is included in the current Viessmann price list.

For usage of ViCare or Vitoguide the respective data protection regulations and terms of use apply.

Push notifications and e-mail services are services provided by network operators for which Viessmann does not accept any liability. In this respect the terms and conditions issued by the relevant network operator apply.

About these Installation Instructions

 Take note of all symbols and notations intended to draw attention to potential hazards or important product information. These include “WARNING”, “CAUTION”, and “IMPORTANT”. See below.

 **WARNING**

Indicates an imminently hazardous situation which, if not avoided, could result in death, serious injury or substantial product/property damage.

► *Warnings draw your attention to the presence of potential hazards or important product information.*

 **CAUTION**

Indicates an imminently hazardous situation which, if not avoided, may result in minor injury or product/property damage.

► *Cautions draw your attention to the presence of potential hazards or important product information.*

IMPORTANT

► *Helpful hints for installation, operation or maintenance which pertain to the product.*



► *This symbol indicates that additional, pertinent information is to be found.*

► *This symbol indicates that other instructions must be referenced.*

Intended Use

In keeping with the intended use, Vitoconnect products should be installed and operated exclusively in conjunction with the electronic control units and controllers of the Viessmann heat generators supported for this purpose. Vitoconnect products are designed for operation in buildings used for residential and business purposes only. Misuse of the appliances is prohibited and will result in exclusion of liability (e.g. commercial or industrial use for a purpose other than for control and regulation). Compliance is required with the installation, service and operating instructions supplied with the product and provided online.

Vitoconnect products are to be used exclusively for monitoring, operation and optimization of the systems, using the user and communications interfaces defined in the printed material of the product. For the communications interfaces, it must be ensured on-site that for all the transmission media used, the system requirements defined in the product documents are met at all times (e.g. the required Wi-Fi connection to a Wi-Fi router). For voltage supply, only the components specified for this purpose may be used (e.g. wall power supplies).

Note: The appliances are designed exclusively for domestic or domestic-like use, i.e. even uninstructed persons can safely operate them.

	Page
Safety	
	Safety Instructions 2
	Operational Safety 3
	Liability 3
General	
	About these Instructions 4
	Intended Use 4
Preparing for Installation	
	Product Information 6
	Spare Parts List 6
	Data Connections with Vitoconnect, Type OPTO2 6
	Operation using the ViCare app 7
	Vitoguide  (for contractors only) 7
	System Requirements 7
	Vitoconnect Installation 8
	Ranges 8
Installation	
	Overview Steps for Installation and Commissioning 9
	Installing the Vitoconnect Wall Bracket 9
	Connection of the OPTO2 10
Commissioning	
	Display and Operating Elements 11
	Checking the Network Settings 13
	Registering the User and Setting up the Heating System . 13
Operating	
	Access Point Mode 14
	Calling up Licences 14
Troubleshooting	
	Measures for Troubleshooting 15
	Restart the Vitoconnect 16
	Resetting to Factory Settings 16
Maintenance	
	Maintenance Mode 17
	Setting up the Wi-Fi after Replacing the Router 17
	Software Update 17
	Maintenance 17
	Cleaning 17
Parts	
	Parts List 18
Specification	
	Specification 19

Product Information

Vitoconnect is a wall-mounted Internet interface that communicates with the boiler control unit of the heat generator.

- Using an Optolink interface, the Vitoconnect type OPTO2 can be used for single-boiler systems.

The Vitoconnect enables remote operation of heating systems over the Internet. For settings and queries the ViCare app is used. A qualified contractor can alternatively control the heating system via Vitoguide.

Heat generator		
Wall mounted or storage combi boilers	Floor standing boilers	Solid fuel boilers
Supported control units		
Vitotronic 200, type <ul style="list-style-type: none"> ■ HO1 ■ HO1A ■ HO1B 	Vitotronic 200, type <ul style="list-style-type: none"> ■ KW2 ■ KW6B Vitotronic 300, type <ul style="list-style-type: none"> ■ KW3 	Vitoligno 300-C with Ecotronic and software version 2.12

Spare Parts List



Information about spare parts can be found in the Viessmann spare parts app.

Data Connections with Vitoconnect, Type OPTO2

In conjunction with heat generators with Optolink interface only

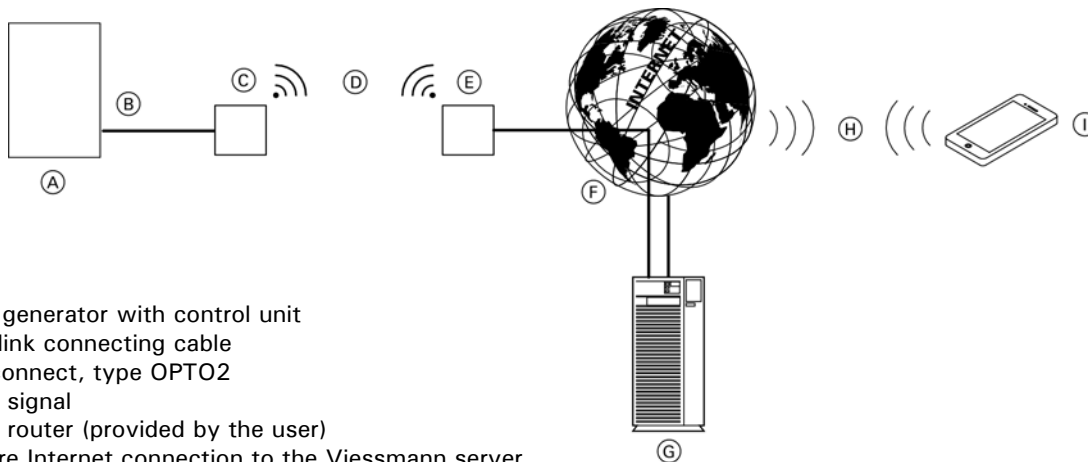

Legend

- (A) Heat generator with control unit
- (B) Optolink connecting cable
- (C) Vitoconnect, type OPTO2
- (D) Wi-Fi signal
- (E) Wi-Fi router (provided by the user)
- (F) Secure Internet connection to the Viessmann server
- (G) Viessmann Server
- (H) Mobile network
or
Wi-Fi connection
- (I) Smartphone

Operation using the ViCare app

With the ViCare app you can operate the heating system remotely over the Internet.
For further information go to www.vicare.info or the App Store or Google Play Store.

Vitoguide (for contractors only)

Your heating system allows remote monitoring by your contractor, once you have granted the required Service clearance.
For further information go to:
www.viessmann.com/vitoguide or the App Store or Google Play Store.

System Requirements

Supported control units

Current overview of the control units supported:
go to www.viessmann.com/vitoconnect.

IP network system requirements

- Wi-Fi router with activated Wi-Fi. The Wi-Fi router must be protected by a sufficiently secure WPA2 password. Unencrypted connections of the Vitoconnect to the Wi-Fi router are discouraged.
- Internet connection with “flatrate” (fixed charge with unlimited time and data) with high availability, i.e. the Vitoconnect is permanently connected to the Viessmann server.
- Network (Wi-Fi) with dynamic IP addressing (DHCP, delivered condition); have an IT professional check this before commissioning; set up if required.
- Define the routing and security parameters for the IP network (LAN): open port 80, port 123, port 443 and port 8883 for directly outgoing connections. Have an IT professional check this on-site before commissioning; set up if required.

Note: During operation, Vitoconnect sets up a secure Internet connection to the Viessmann server. Connections of the Vitoconnect with other servers are not possible.

User account

Regardless of the operating unit, the Vitoconnect requires a valid user account for the Viessmann server. This account is registered automatically at the time of commissioning via the ViCare app: see page 18.

Operating unit for ViCare app

The ViCare app supports end devices running one of the following operating systems:

- Apple iOS
- Google Android

Note:

- Compatible versions: see the App Store or Google Play.
- For more information go to www.vitodata.info.

Message destinations

End device for receiving email, for example computer, smartphone or tablet PC.

Vitoconnect Installation

Wall mounted indoors installation only

- The installation location must be dry and frost-free.
- Ensure ambient temperatures between 41 and 104°F (+5 and +40°C).
- Distance from the heat generator min. 1 ft. (0.3 m) and max. 8 ft. (2.5 m)
- 120 V/60 Hz outlet max. 5 ft. (1.5 m) from the installation site
- Internet access with an adequate Wi-Fi signal

Note: The Wi-Fi signal can be strengthened with a commercially available Wi-Fi repeater.

Note:

- Observe the lengths of the supplied connecting cables when selecting the installation site.
- Keep the distance between the Vitoconnect and the Wi-Fi router as small as possible to ensure a good Wi-Fi connection.

Connecting cables	Length
Wall power supply with connecting cable	5 ft. (1.5 m)
Optolink connecting cable to connect the Vitoconnect to the boiler control unit	10 ft. (3 m)

Ranges

The range of Wi-Fi connections can be reduced by walls, ceilings and furniture. The strength of the Wi-Fi signal gets reduced and reception can be disturbed.

Reduction of the range:

- Wi-Fi signals get attenuated on the way from the transmitter to the receiver, for example, through the air and when penetrating walls.
- Wi-Fi signals are reflected by metallic parts, for example, reinforcement in walls, metal foils of heat insulation and metallized thermo-glass for heat insulation.
- Wi-Fi signals are cut off by supply blocks and lift shafts.
- Wi-Fi signals are disturbed by devices that also work with high-frequency signals. Keep a distance of at least 6.5 ft. (2 m) to the following devices:
 - Computers
 - Audio and video systems
 - Radio signals
 - Electronic transformers
 - Ballasts

Note: We recommend keeping the distance between the Vitoconnect and the Wi-Fi router as small as possible to ensure a good Wi-Fi connection.

Overview Steps for Installation and Commissioning

Work steps	Responsible party	Type OPTO2 on page
Installation		
1	Check the system requirements.	Heating contractor IT professional
2	Install the wall bracket for the Vitoconnect.	Heating contractor IT professional
3	Connect the Vitoconnect to the heat generator.	Heating contractor IT professional
4	Insert the Vitoconnect in the wall bracket.	Heating contractor IT professional
5	Set up the Vitoconnect power supply connection.	Heating contractor IT professional
Commissioning		
1	Check the network settings.	IT professional
2	Register the user and set up the heating system.	Heating contractor System operator

Installing the Vitoconnect Wall Bracket

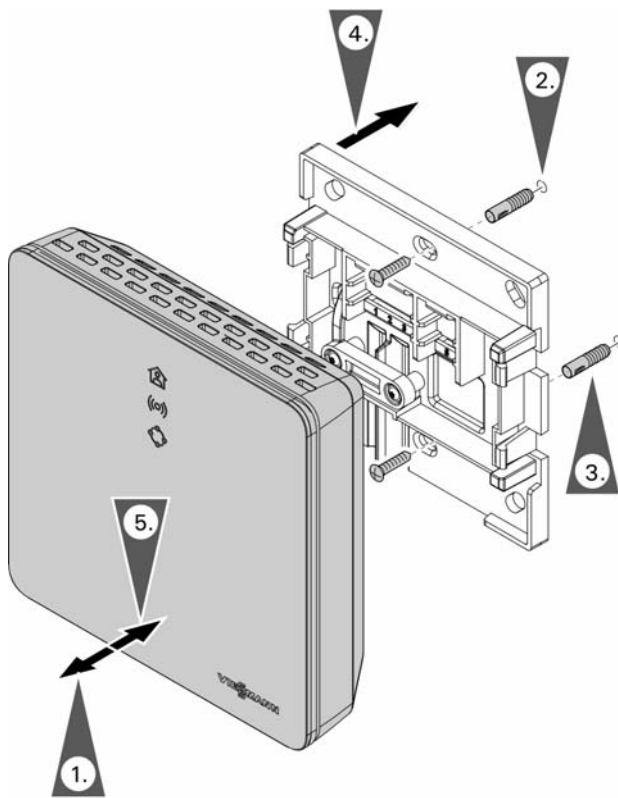

1. Remove the front cover from the back plate.
2. Drill a hole for the wall plug using a \varnothing 3/16 in. (5 mm) drill.
3. Insert the wall plug.
4. Mount the back plate to the wall.
5. Snap the front cover to the back plate.

Connection of the OPTO2

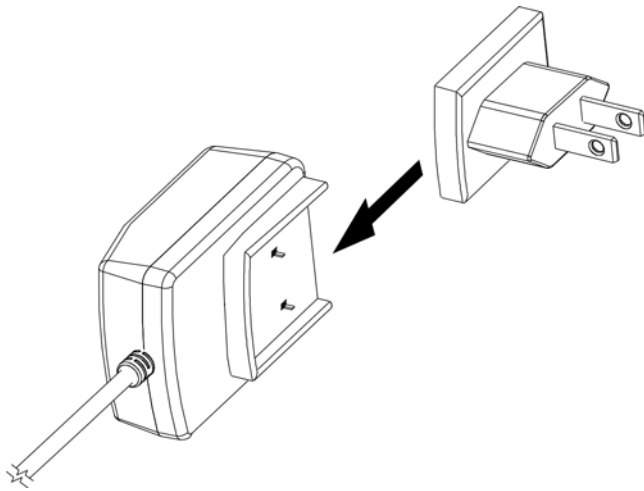

1. Insert the AC plug into the power supply until it locks in place.

Vitoconnect bottom view

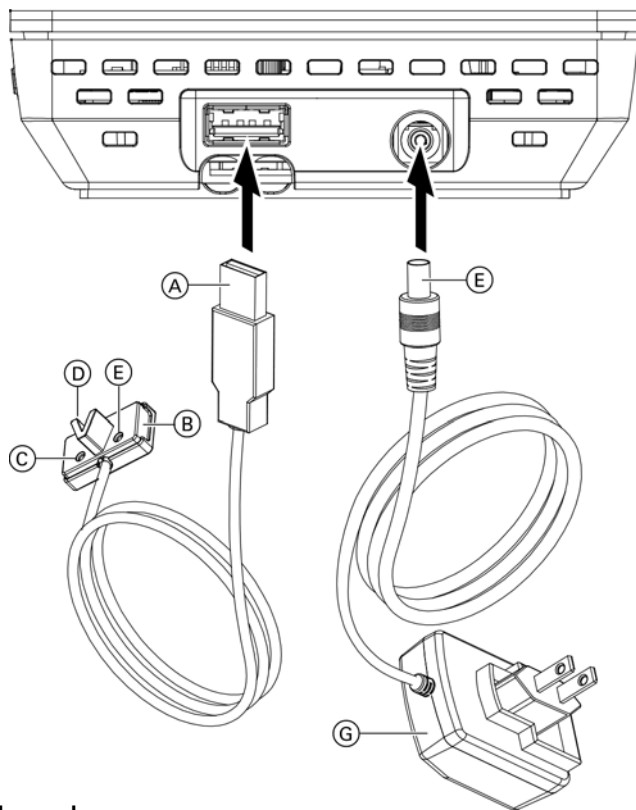

1. Insert the USB plug (A) of the Optolink/USB connecting cable into connection of the Vitoconnect.
2. Connect the Optolink plug (B) of the Optolink/USB connecting cable with the Optolink interface at the control unit of the heat generator.



Connection to the heat generator
Operating instructions of the heat generator

The wall power supply must be located in the vicinity of the appliance and be freely accessible.

1. Insert the barrel connector of the wall power supply into the connection (E) of the Vitoconnect.
2. Insert the wall power supply (G) for Vitoconnect into the socket.



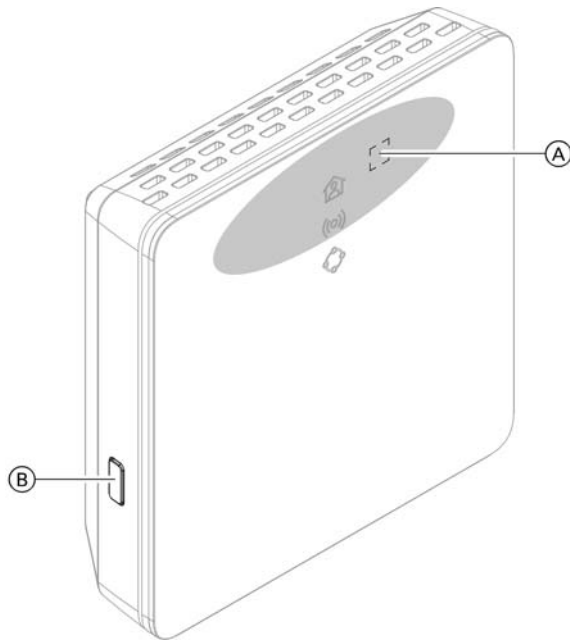

Legend

- (A) USB connector
- (B) Optolink connector
- (C) Fault display
- (D) Optolink interface
- (E) Operation indicator
- (F) Barrel power connector
- (G) Wall power supply

Display and Operating Elements







Legend

- (A) Operating button
- (B) Reset button
-  LED indicates the current operating status.
-  LED indicates the state of the communication with the Wi-Fi and Viessmann server.
-  LED indicates the system functions and communication with the heat generator (maintenance mode, restart, update, error).
-  = Actuation area of the operating button (A)

Display and Operating Elements *(continued)*

Meaning of the LEDs

LED  – operating status	
Illuminated in white.	Connection between Vitoconnect and the heat generator and Viessmann server established successfully
LED  – communication with the Wi-Fi and Viessmann server	
Illuminated in green.	<ul style="list-style-type: none"> ■ Vitoconnect is starting. or ■ Access point mode is active.
Pulsating in yellow.	Connection between Vitoconnect and Wi-Fi router failed: see page 15.
Illuminated in yellow.	No Internet connection: see page 15.
Illuminated in red.	Connection between Vitoconnect and Viessmann server failed: see page 15.
LED  – system functions and communication with heat generator	
Illuminated in green.	<ul style="list-style-type: none"> ■ Vitoconnect is starting. or ■ A new software is being installed. <p>IMPORTANT Do not damage the Vitoconnect. During software installation, do not disconnect the Vitoconnect from the power supply.</p>
Rapidly flashes yellow.	No connection to the heat generator: see page 15.
Pulsating in red.	Maintenance mode (no data transfer to the Viessmann server).
Flashes red.	Vitoconnect is ready to be reset to the delivered condition: see page 15.
Illuminated in red.	Error in the control unit of the heat generator: see page 15.
LED  and  – software or hardware error	
Rapidly flashes red.	Software or hardware error: see page 15.

Note:

Slowly pulsating: The LED flashes once every 4 seconds bright and darker.

Pulsating: The LED flashes once every second bright and darker.

Flashing: The LED is on once every second.

Rapid flashing: The LED is on twice every second.

Checking the Network Settings

Have the following settings on the Wi-Fi router checked and adjusted by an IT professional, if required:

- Dynamic IP addressing must be active.
- Port 80, port 123, port 443 and port 8883 must be open for outgoing connections.



Registering Users and Setting up the Heating System

1. Download the ViCare app from the App Store or Google Play Store and install it.
2. Start the ViCare app and tap "Create account".
3. Follow the instructions in the ViCare app.
4. Scan the QR code.

or

Enter the "S/N" and "ID".

Note: QR code, "S/N" and "ID": See the supplied Vitoconnect sticker.

5. Set up the Vitoconnect Wi-Fi: see the next chapter.
6. Connect the Vitoconnect to your home network.
 - The LED  illuminates white to indicate that the Vitoconnect and ViCare app have been set up: See chapter "Display and controls".
Note: This process can take up to 5 minutes.
 - If the LED  illuminates red, the attempt to establish a connection has failed: See chapter "Troubleshooting measures".
 - Once the LED  illuminates green, connect the Vitoconnect to your home network again. (see information starting on page 11)

Android operating system: Setting up Wi-Fi

Automatic Wi-Fi connection with "VITOCONNECT-<xxxx>".

iOS operating system: Setting up Wi-Fi

1. Open the Wi-Fi settings of your smartphone.
2. Connect your smartphone to the "VITOCONNECT-<xxxx>" Wi-Fi. You will be prompted to enter a password.

Note: The WPA2 password will automatically be in the clipboard.

3. Insert the WPA2 password from the clipboard.

Access Point Mode

Activate access point mode for the device so that you can access legal information online, e.g. open source licences, or to change the WiFi router settings.

Activate the access point mode, e.g. after replacing the Wi-Fi router.

Activating access point mode



Press the operating button  (see page 11) for longer than 5 seconds, but not longer than 30 seconds.

LED  illuminated in green: Access point mode is active.

Deactivating access point mode

1. Access point mode is automatically deactivated after 5 min.

or

2. Again, press the operating button  (see page 11) for longer than 5 seconds, but not longer than 30 seconds. LED  no longer illuminated. Access point mode is deactivated.

Note: On commissioning, access point mode is activated automatically as soon as you plug in the wall power supply. Access point mode remains active until commissioning of the Vitoconnect has completed. There is no need to manually deactivate access point mode.

Calling up Licences

This product contains third party and/or open source software. You are entitled to use this third party software subject to compliance with the respective licence conditions.

Calling up open source licences

1. Activate access point mode for the Vitoconnect:
See page 21.
2. Call up the WiFi settings of your smartphone or PC.
3. Connect your smartphone or PC to the WiFi network "Viessmann- <xxxx>".
You will be prompted for a password.
4. Enter the WPA2 password.
Note: The WPA2 password can be found on the enclosed label.
5. Go to the internet browser on your smartphone and open <http://vitoconnect.gateway> or <http://169.254.11.1>
6. Then follow the link "Open Source Components Licenses".

Measures for Troubleshooting

Internet connection interrupted

If the internet connection is interrupted, you will no longer be able to make settings via the ViCare app.



Faults at the Vitoconnect are shown by various LED indications: see page 12.

Only in conjunction with Vitoconnect, type OPTO2

- You can change all settings on the control unit of the heat generator.



Operating instructions for the heat generator

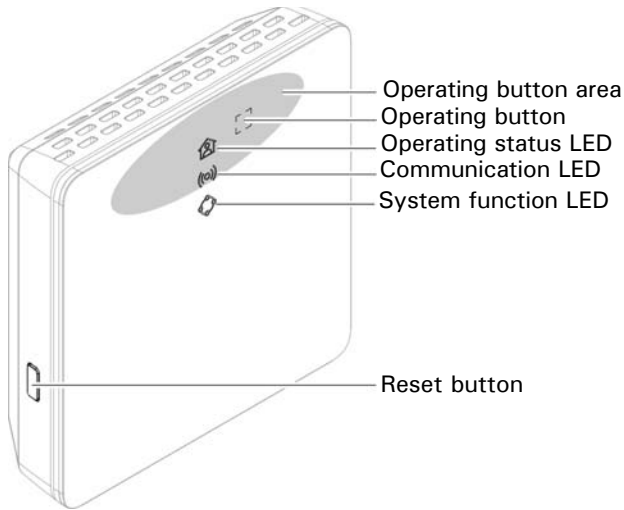

LED (🔴)	Type of fault and measures
Pulsating in yellow.	Connection between Vitoconnect and Wi-Fi router failed: <ul style="list-style-type: none"> ■ Check the password at the time of Wi-Fi commissioning. ■ Check the connection to the WiFi router. ■ Restart the Vitoconnect: see page 16.
Illuminated in yellow. or Illuminated in red.	No Internet connection or No connection to the Viessmann server <ul style="list-style-type: none"> ■ No Wi-Fi connection <ul style="list-style-type: none"> – Check the network setting at the time of Wi-Fi commissioning. – Check the password at the time of Wi-Fi commissioning. ■ Inadequate Wi-Fi signal strength <ul style="list-style-type: none"> – Change the installation site of the Vitoconnect: see page 9. ■ Wi-Fi connection has been established, but there is no Internet connection. <ul style="list-style-type: none"> – Check the Internet connection with another device, e.g. a laptop. If an Internet connection cannot be established with other devices either, have your network settings checked by an IT professional. ■ Restart the Vitoconnect: see page 16.
Rapidly flashes red.	Software error or hardware fault <ul style="list-style-type: none"> ■ Restart the Vitoconnect: see page 16. ■ Replace the Vitoconnect, if required.
LED 🔄	
Flashes yellow.	Communication error with the Vitotrol 100, type OT1 <ul style="list-style-type: none"> ■ Check the OpenTherm connecting cable to the Vitotrol 100, type OT1: See page 16. ■ Restart the Vitoconnect: See page 16.
Rapidly flashes yellow.	No connection to the heat generator <ul style="list-style-type: none"> ■ Check the plug-and-socket connections (Optolink, USB). ■ Check the connecting cables (Optolink). ■ Restart the Vitoconnect: see page 16.
Rapidly flashes red.	Software error or hardware fault <ul style="list-style-type: none"> ■ Restart the Vitoconnect: see page 16. ■ Replace the Vitoconnect, if required.
Illuminated in red.	Fault in the control unit of the heat generator <ul style="list-style-type: none"> ■ Observe the message in the ViCare app. <div style="display: flex; align-items: center;">  <div style="margin-left: 10px;">  <p>Heat generator installation and service instructions</p> </div> </div>
Faults without LED indications	
Fault	Measures
All Vitoconnect LEDs are off.	Check the power supply connection and the wall power supply for the Vitoconnect.

Restarting the Vitoconnect





After rectifying the fault, the Vitoconnect has to be restarted.

Simultaneously press the Reset button and the operating button for approx. 15 seconds:

- LED  and  illuminated in green: The start-up phase can last up to 2 minutes.
- LED  illuminated in white: Vitoconnect is ready.

Resetting to Factory Settings

You can reset all changed values to their factory settings.

1. Press the Reset button (see above) for at least 30 seconds:
LED  flashes red.
2. Press the Reset button (see above) once again within 5 seconds.
LED  no longer illuminated.
Vitoconnect restarts.

Setting up Wi-Fi after Replacing the Router

1. Activate the Vitoconnect access point mode: see page 14.
2. Open the Wi-Fi settings of your smartphone.
3. Connect your smartphone to the "VITOCONNECT-<xxxx>" Wi-Fi.
4. Enter the WPA2 password.
Note: The WPA2 password can be found on the supplied sticker.
5. Use the Internet browser on your smartphone to access <http://vitoconnect.gateway> or <http://169.254.11.1>
6. On the starting page, select "Select router".
7. Follow the instructions on the Internet page.
8. Access point mode is automatically deactivated after 5 min.
or
Manually deactivate the Vitoconnect access point mode: see page 14.

Software Update

Any available software updates will be automatically downloaded. During the update, the LED  will be illuminated in green. This can last up to 5 minutes. Once the update is complete, the Vitoconnect will restart.

Note: During commissioning, the Vitoconnect software is automatically updated as soon as the Vitoconnect is connected to the internet.

Maintenance

The Vitoconnect is maintenance-free.

Cleaning

You can clean the surface of the appliance with a microfibre cloth. Don't use any cleaning agents.

Specification

Vitoconnect

Rated voltage	12VDC
Wi-Fi frequency	2,4 GHz
Wi-Fi encryption	Unencrypted or WPA2
Frequency band	2400.0 to 2483.5 MHz
Max. transmitting power	0.1 W (e.i.r.p.)
Internet protocol	IPv4
IP assignment	DHCP
Rated current	0.5A
Power consumption	5.5 W
Permissible ambient temperature	
■ Operation	41 to 104°F (+5 to +40°C) Installation in living spaces or boiler rooms (standard ambient conditions)
■ Storage and transport	-4 to 140°F (-20 to +60°C)

Wall power supply

Rated voltage	100 to 240VAC
Rated frequency	50/60 Hz
Output voltage	12VDC
Output current	1A
Permissible ambient temperature	
■ Operation	41 to 104°F (+5 to +40°C) Installation in living spaces or boiler rooms (standard ambient conditions)
■ Storage and transport	-4 to 140°F (-20 to +60°C)

Quick Reference

°C	°F
-40	-40
-35	-31
-25	-13
-20	-4
-18	0
-16	+3
-14	+7
-12	+10
-10	+14
-9	+16
-8	+18
-7	+19
-6	+21
-5	+23
-4	+25
-3	+27
-2	+28
-1	+30
0	+32
+1	+34
+2	+36
+3	+37
+4	+39
+5	+41
+6	+43
+7	+45
+8	+46
+9	+48
+10	+50
+12	+54
+14	+57
+16	+61
+18	+64
+20	+68
+25	+77
+30	+86
+35	+95
+40	+104
+50	+122
+60	+140
+70	+158
+80	+176
+90	+194
+100	+212
+110	+230

Printed on environmentally friendly
(recycled and recyclable) paper.



Technical information subject to change without notice.

Scan for
digital copy
of this
document



Viessmann Manufacturing Company Inc.
750 McMurray Road
Waterloo, Ontario • N2V 2G5 • Canada
TechInfo Line 1-888-484-8643
1-800-387-7373 • Fax (519) 885-0887
www.viessmann.ca • info@viessmann.ca

Viessmann Manufacturing Company (U.S.) Inc.
45 Access Road
Warwick, Rhode Island • 02886 • USA
TechInfo Line 1-888-484-8643
1-800-288-0667 • Fax (401) 732-0590
www.viessmann-us.com • info@viessmann-us.com