

PRODUCT SPECIFICATIONS

Elkay Quartz Luxe® 33" x 19" x 10" Equal Double Bowl Undermount Sink with Aqua Divide. Proprietary manufacturing process that combines natural quartz with high performance UV-stable acrylic resins results in an impact resistant, nonporous and heat-, scratch-, stain- and fade-resistant surface. Naturally sound deadening and Rear Center drain placement.

Installation Type:	Undermount
Material:	Quartz
Special Features:	Aqua Divide
Finish:	Caviar (CA), Charcoal (CH), Chestnut (CN), Parchment (PA), Ricotta (RT)
Number of Bowls:	2
Sink Dimensions:	33" x 19" x 10"
Bowl 1 Dimensions:	15-3/16" x 16-3/4" x 10"
Bowl 2 Dimensions:	15-3/16" x 16-3/4" x 10"
Drain Size:	3-1/2" (89mm)
Drain Location:	Rear Center
Minimum Cabinet Size:	36"
Mounting Hardware:	Part # 1000003442 included
Template Included:	Yes
Cutout Template #:	1000003466

Template is available for download at [elkay.com](#). CAD software will be required to open the template.

Special Note: Reserve Selection products are sold exclusively, in-store and online, through authorized wholesalers.



A Century of Tradition and Quality. For more than 100 years, Elkay has been making innovative products and providing exceptional customer care. We take pride in offering plumbing products that make life easier, inspire change and leave the world a better place.



Product Compliance: CSA B45.5/IAPMO Z124

Sinks are listed by IAPMO® as meeting the applicable requirements of the Uniform Plumbing Code®, International Plumbing Code®, and National Plumbing Code of Canada.

[Clean and Care Manual \(PDF\)](#)
[Installation Instructions \(PDF\) - 1000005238](#)
[Warranty \(PDF\)](#)

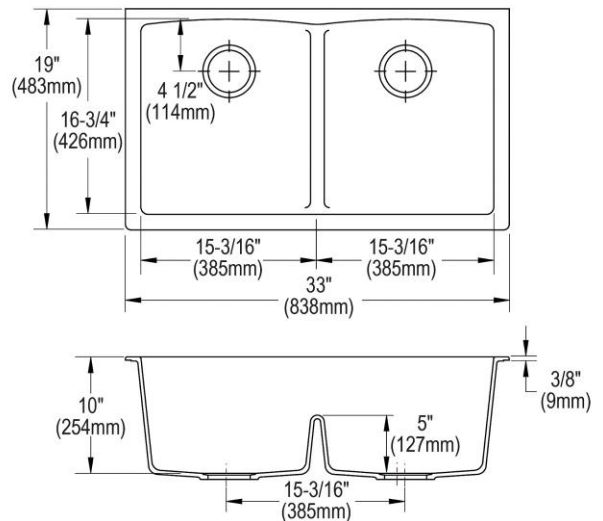



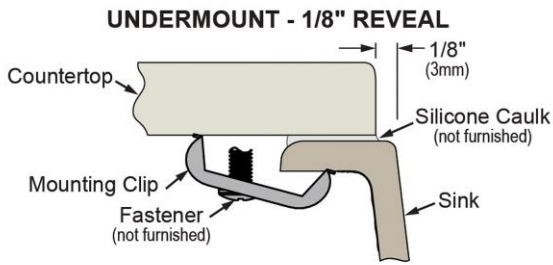

PART: _____ QTY: _____
 PROJECT: _____
 CONTACT: _____
 DATE: _____
 NOTES: _____
 APPROVAL: _____

In keeping with our policy of continuing product improvement, Elkay reserves the right to change product specifications without notice. Please visit [elkay.com](#) for the most current version of Elkay product specification sheets. This specification describes an Elkay product with design, quality, and functional benefits to the user. When making a comparison of other producers' offerings, be certain these features are not overlooked.

Installation Profile:



Designed to affix to the underside of any solid surface countertop.

Optional Accessories		
LKOBG1415SS	Elkay Stainless Steel 12-3/4" x 14-1/2" x 1" Bottom Grid Spec Sheet (PDF)	
LK99	Elkay Deluxe 3-1/2" Drain Type 304 Stainless Steel Body Strainer Basket Rubber Seal and Tailpiece Spec Sheet (PDF)	
LKQD35	Elkay Polymer 3-1/2" Disposer Flange with Removable Basket Strainer and Rubber Stopper Spec Sheet (PDF)	
LKQS35	Elkay Polymer 3-1/2" Drain Fitting with Removable Basket Strainer and Rubber Stopper Spec Sheet (PDF)	
LKEC2031	Elkay Explore Single Hole Kitchen Faucet with Pull-down Spray and Forward Only Lever Handle Spec Sheet (PDF)	
LK6000	Elkay Everyday Single Hole Deck Mount Kitchen Faucet with Pull-down Spray Forward Only Lever Handle Spec Sheet (PDF)	

In keeping with our policy of continuing product improvement, Elkay reserves the right to change product specifications without notice. Please visit elkay.com for the most current version of Elkay product specification sheets. This specification describes an Elkay product with design, quality, and functional benefits to the user. When making a comparison of other producers' offerings, be certain these features are not overlooked.