

### Features

- Frameless design emphasizes glass and creates a sleek, minimalist look
- Innovative roller design with stainless steel bearings simplifies installation and provides out-of-plumb adjustability while glass is installed
- Interior and exterior towel bars provide integrated storage on the doors
- Cushioned center guide provides smooth, quiet sliding action
- CleanCoat®+ glass coating creates a hydrophobic barrier that repels water, soap scum, and residue, saving time and protecting shower doors 10 times longer than original CleanCoat. (Based on 2021 internal wear/abrasion testing using a microfiber cloth.)
- Smooth, easy-to-clean wall jambs
- Tempered glass ensures enhanced safety and durability

### Material

- Frameless, 3/8" (10 mm) thick Crystal Clear tempered glass
- Anodized aluminum prevents rust and corrosion

### Installation

- Fits opening widths 56-5/8" – 59-5/8" (1438 – 1514 mm)
- 81-5/8" (2073 mm) high, with a lofty 75-5/8" (1921 mm) minimum head clearance
- 3" (76 mm) width adjustment
- Out-of-plumb adjustability simplifies installation
- For residential use only
- Not for use in hospitality



### Codes/Standards

ANSI Z97.1  
CAN/CGSB-12.1  
CPSC 16CFR 1201

### KOHLER® Bath and Shower Doors Ten-Year Limited Warranty

See website for detailed warranty information.

### Available Colors/Finishes

*Color tiles intended for reference only.*

Color	Code	Description
	SHP	Bright Polished Silver
	2MB	Vibrant® Brushed Moderne Brass
	BL	Matte Black
	BNK	Anodized Brushed Nickel

### Available Glass Options

Code	Description
L	Crystal Clear

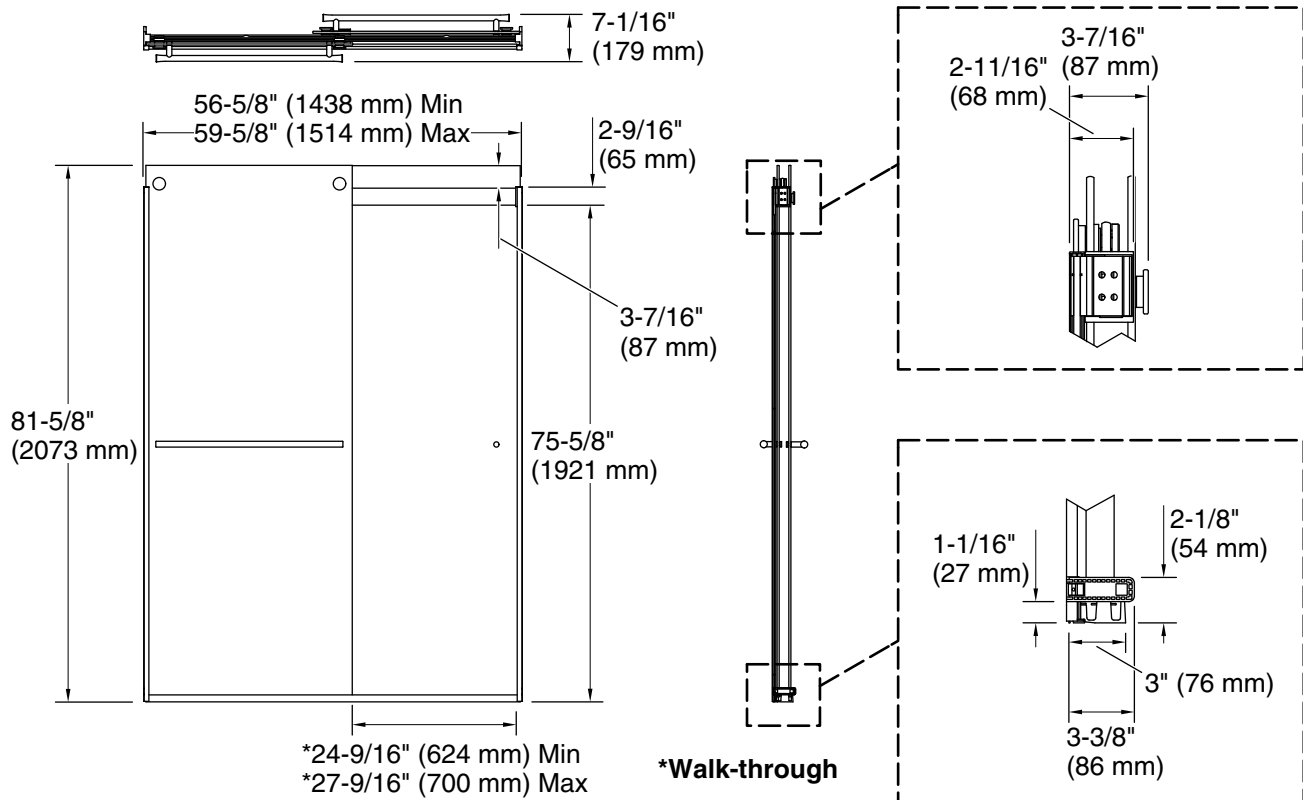

### Technical Information

All product dimensions are nominal.

Base-To-Wall	1/2" (13 mm)
Radius – Max:	
Shower Ledge Min	2-1/2" (64 mm)
Flat:	
Shower Wall Min	3-1/2" (89 mm)
Flat:	

### Notes

Install this product according to the installation instructions.

The vertical opening should be a minimum of 84-5/8" (2149 mm) to allow for installation clearance.