

**Features**

- Frameless
- 1/4" (6 mm) thick tempered glass
- CleanCoat®+ glass coating creates a hydrophobic barrier that repels water, soap scum, and residue, saving time and protecting shower doors 10 times longer than original CleanCoat. (Based on 2021 internal wear/abrasion testing using a microfiber cloth.)
- Reversible top track offers a choice of curved or flat profile
- Interior and exterior towel bars complete the look of this door
- Tempered glass ensures enhanced safety and durability

**Material**

- Anodized aluminum prevents rust and corrosion

**Installation**

- Out-of-plumb adjustability simplifies installation
- Not for use in hospitality
- For residential use only



**Codes/Standards**

ANSI Z97.1  
CAN/CGSB-12.1  
CPSC 16CFR 1201











**STERLING® Bath and Shower Doors  
Five-Year Limited Warranty**

See website for detailed warranty information.

**Available Colors/Finishes**

*Color tiles intended for reference only.*

**Color Code Description**

	S	Silver
	DR	Deep Bronze
	DR	Deep Bronze
	DR	Deep Bronze
	N	Nickel
	N	Nickel
	N	Nickel
	PBL	Matte Black
	PBL	Matte Black
	S	Silver
	S	Silver

**Available Glass Options**

**Code Description**

Boxwood™  
Cirkette™

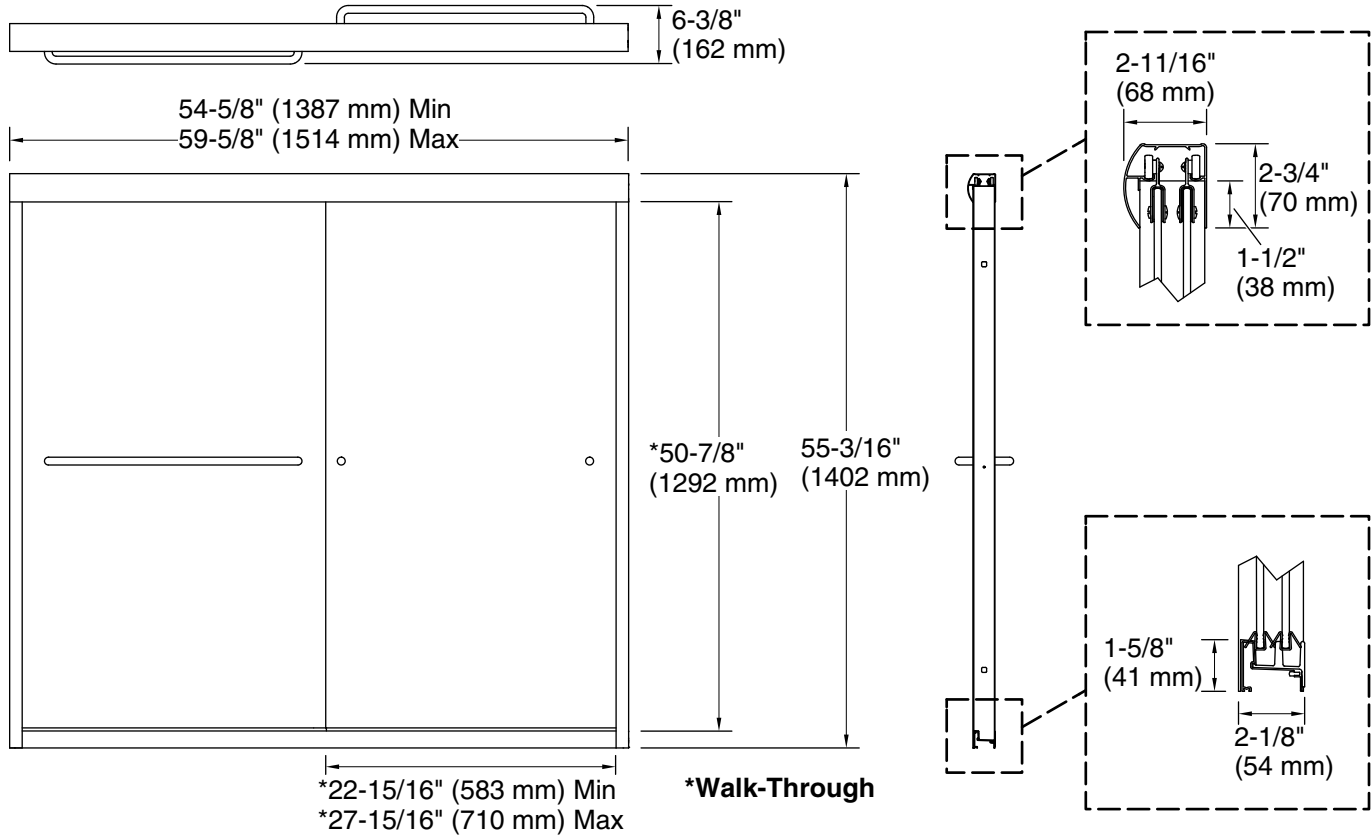

**Technical Information**

All product dimensions are nominal.

- Base-To-Wall 1/2" (13 mm)
- Radius – Max:
- Shower Ledge Min 2-1/8" (54 mm)
- Flat:
- Shower Wall Min 2-11/16" (68 mm)
- Flat:

**Notes**

Install this product according to the installation guide.

The vertical opening should be a minimum of 57-1/2" (1461 mm) to allow for installation clearance.