

9013FF
3-hole tee gusset
3-1/2" x 3-1/2"

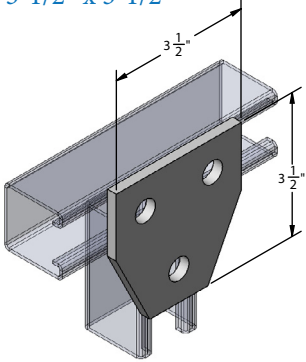

Materials/Finishes:	Zinc Plated (9013FFZ)
Thickness:	1/4"
Hole Dim:	9/16"
Wgt. each (lbs)	.70

9016FF
4-hole tee plate
3-1/2" x 5-3/8"

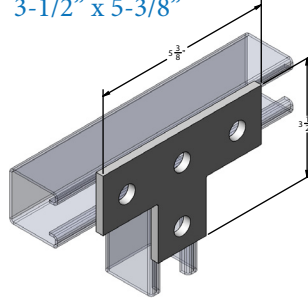

Materials/Finishes:	Zinc Plated (9016FFZ)
	T-304 Stainless (9016FFSS)
	T-316 Stainless (9016FFSX)
Thickness:	1/4"
Hole Dim:	9/16"
Wgt. each (lbs)	..75

9017FF
4-hole cross plate
5-3/8" x 5-3/8"

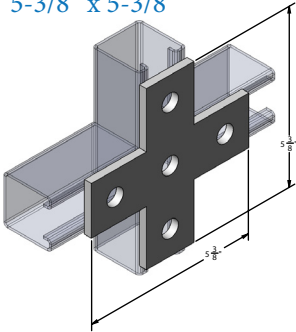

Materials/Finishes:	Zinc Plated (9017FFZ)
	T-304 Stainless (9017FFSS)
	T-316 Stainless (9017FFSX)
Thickness:	1/4"
Hole Dim:	9/16"
Wgt. each (lbs)	1.00

9018FF
4-hole tee gusset
3-1/2" x 5-3/8"

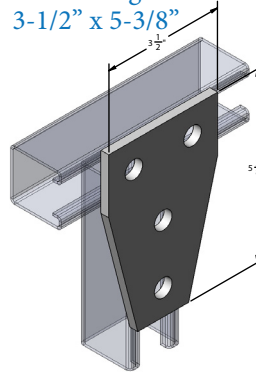

Materials/Finishes:	Zinc Plated (9018FFZ)
Thickness:	1/4"
Hole Dim:	9/16"
Wgt. each (lbs)	1.00

9019FF
5-hole tee gusset
5-3/8" x 5-3/8"

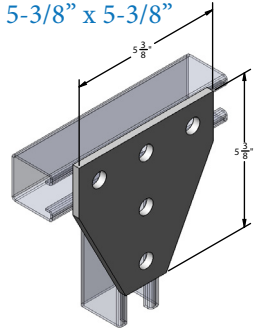

Materials/Finishes:	Zinc Plated (9019FFZ)
Thickness:	1/4"
Hole Dim:	9/16"
Wgt. each (lbs)	1.43

9021FF
7-hole cross gusset
5-3/8" x 9-1/8"

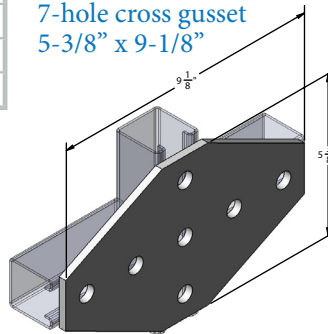

Materials/Finishes:	Zinc Plated (9021FFZ)
Thickness:	1/4"
Hole Dim:	9/16"
Wgt. each (lbs)	2.31

PROJECT INFORMATION			APPROVAL STAMP
Project:			Notes:
Address:			
Contractor:			
Engineer:			
Date:			
Approved	Approved as Noted	Not Approved	