

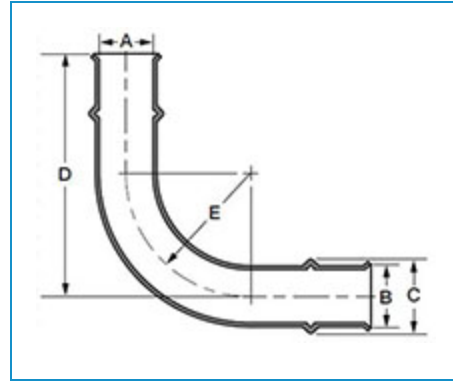

RLS LLC
833-RLS-FAST (833-757-3278)

Part Number 3031222200111, 3031 - 90° Elbow - Press x Press



[Specifications](#) | [Dimensions](#)

Specifications

Size 1	1 3/8
Size 2	1 3/8
Fitting Body Material	Refrigerant Grade Copper, per ASTM-B75 or ASTM-B743
O-Ring Material	HNBR
Maximum Rated Pressure (MRP)	700 psi
Continuous Operating Temperature	250 °F
End Type	Press End
Weight	0.98 lb

Dimensions

Angle	90 °
A	1.39 in
B	1.54 in
C	1.75 in
D	4.54 in
E	2.75 in