

## Features

- Solid brass construction ensures durability and reliability.
- KOHLER finishes resist corrosion and tarnishing, exceeding industry durability standards over two times.
- Without overflow.
- For use in non-overflow applications.



## Codes/Standards









ASME A112.18.2/CSA B125.2

## Kohler One-Year Limited Warranty

See website for detailed warranty information.

## Available Color/Finishes

*Color tiles intended for reference only.*

Color	Code	Description
	CP	Polished Chrome
	SN	Vibrant® Polished Nickel
	PB	Vibrant® Polished Brass
	BN	Vibrant® Brushed Nickel
	BN	Vibrant® Brushed Nickel
	BV	Vibrant® Brushed Bronze
	2BZ	Oil-Rubbed Bronze
	VNT	Vintage Nickel

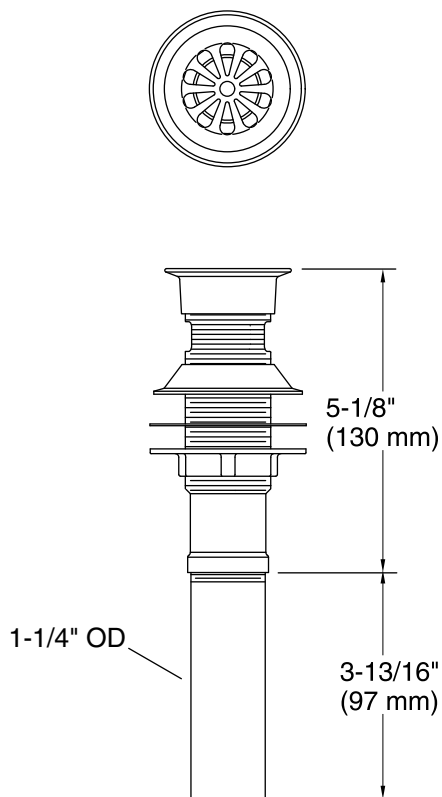

## Technical Information

All product dimensions are nominal.

## Notes

Install this product according to the installation guide.