

Features

- Vitreous china.
- Comfort Height® Elongated bowl.
- AquaPiston® flushing system.
- Includes left-hand polished chrome trip lever.
- 1.28 gpf (4.8 lpf)
- 2-1/8" fully glazed Concealed trapway.
- 12" (305 mm) rough-in.
- Less seat and supply line.
- 11-1/8" (283mm) x 8-1/2" (217mm) water area.
- 29-5/8" (752mm) x 18-7/8" (479mm) x 31-7/16" (799mm).
- Clean Caps low-profile bolt caps.

Recommended Accessories

- K- 7637 Angle Supply with Stop (single)
- K- 4733 Toilet Seat

Components

Product includes:

- K- 4434 Toilet Tank
- K- 5626 Comfort Height Elongated Bowl
- Additional included component/s: Tank cover, K-9167-L Trip lever, Bolt cap accessory pack, and Tank accessory pack.



ADA **CSA B651** **OBC**







Codes/Standards

ASME A112.19.2/CSA B45.1
 DOE - Energy Policy Act 1992
 EPA WaterSense®
 ADA
 ICC/ANSI A117.1
 CSA B651
 OBC

See website for detailed warranty information.

Available Color/Finishes

Color tiles intended for reference only.

Color	Code	Description
	0	White
	96	Biscuit
	47	Almond
	NY	Dune
	95	Ice™ Grey
	G9	Sandbar
	7	Black Black™

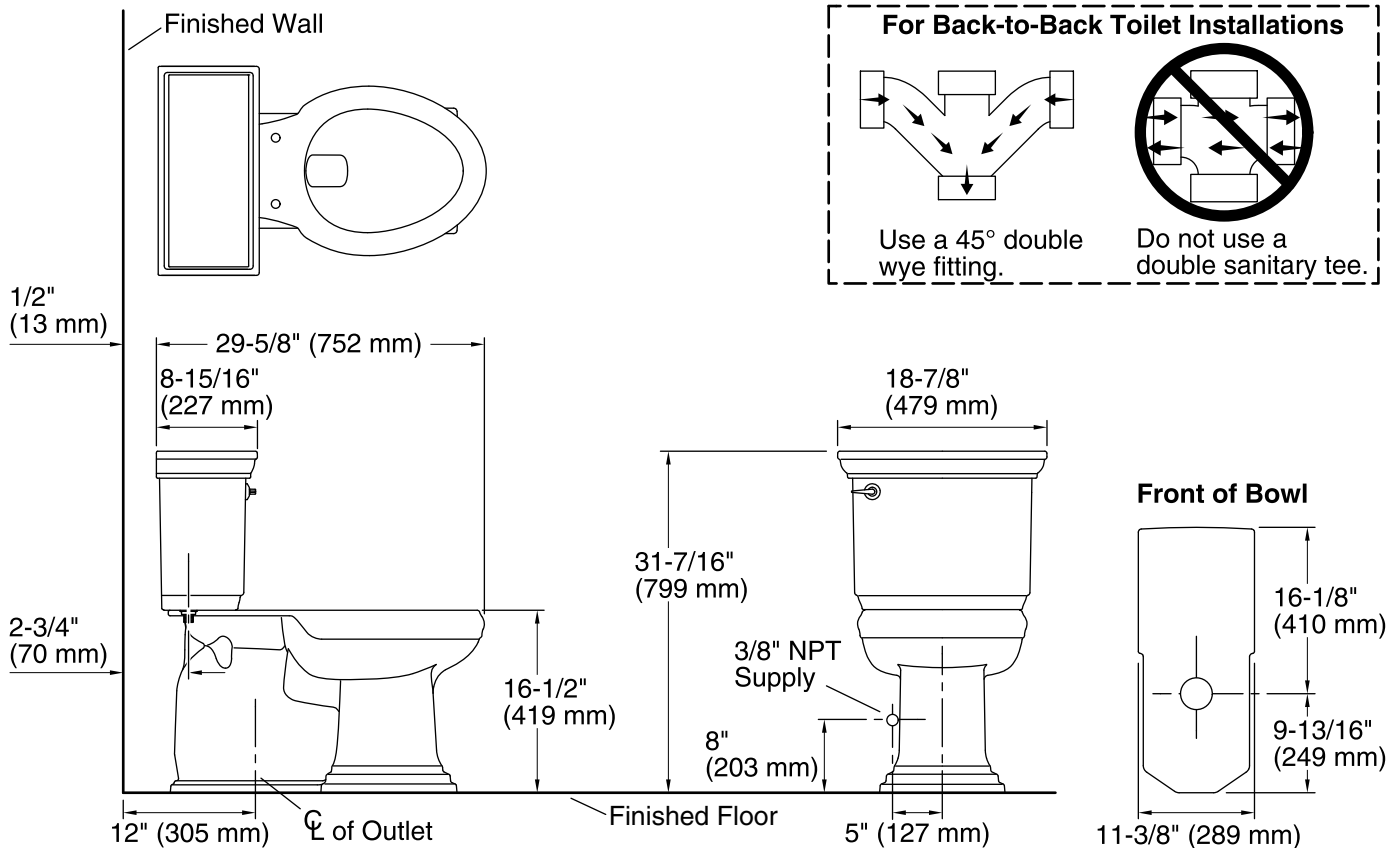

Technical Information

All product dimensions are nominal.

Toilet type:	Two-piece
Bowl shape:	Elongated front
Flush type:	AquaPiston
Trap passageway:	2" (51 mm)
Water Consumption	
Full:	1.28 gpf (4.8 lpf)
Water surface size:	11-1/8" x 8-1/2" (283 mm x 216 mm)
Rim to water surface:	5-3/8" (137 mm)
Rough-in:	12" (305 mm)

Notes

Install this product according to the installation guide.

For back-to-back toilet installations: Use only a 45° double wye fitting.

ADA, OBC, CSA B651 compliant when installed to the specific requirements of these regulations.

The Model Plumbing Codes require the installation of elongated open-front toilet seats on public bathrooms.