

Features

- Pressure-balancing diaphragm technology maintains outlet temperature within +/-3°F during water pressure fluctuations
- Antiscald protection
- A single handle controls both on/off activation and temperature setting
- MasterClean™ sprayface features an easy-to-clean surface that withstands mineral buildup
- Coordinates with other products in the Tone collection
- Requires Rite-Temp® pressure-balancing valve (sold separately)

Material

- Premium material construction with metal handle ensures reliability and durability
- KOHLER finishes resist corrosion and tarnishing

Required Products/Accessories

- K-8304 Series Rite-Temp® Valve & Cartridge Kits
- or
- K-8300 Series Rite-Temp® Valve Body Rough-ins
- K-8305 Series Rite-Temp® Cartridges

Adapters, Rough-in and Extension Kits

- 10350 Range: 3-1/2" (89 mm) - 4-1/4" (108 mm)

Recommended Products/Accessories

- K-23723 Faucet cleaner

Optional Products/Accessories

- K-10350 Deep rough-in kit
- K-10351 Test cap for K-8300 Series valve bodies
- 1307346
- 1362395



Codes/Standards







- ASME A112.18.1/CSA B125.1
- DOE - Energy Policy Act 1992

KOHLER® Faucet Lifetime Limited Warranty

See website for detailed warranty information.

Available Colors/Finishes

Color tiles intended for reference only.

Color	Code	Description
	CP	Polished Chrome
	BN	Vibrant® Brushed Nickel
	BL	Matte Black
	2MB	Vibrant® Brushed Moderne Brass
	CBL	Matte Black with Polished Chrome
	BMB	Matte Black with Moderne Brass

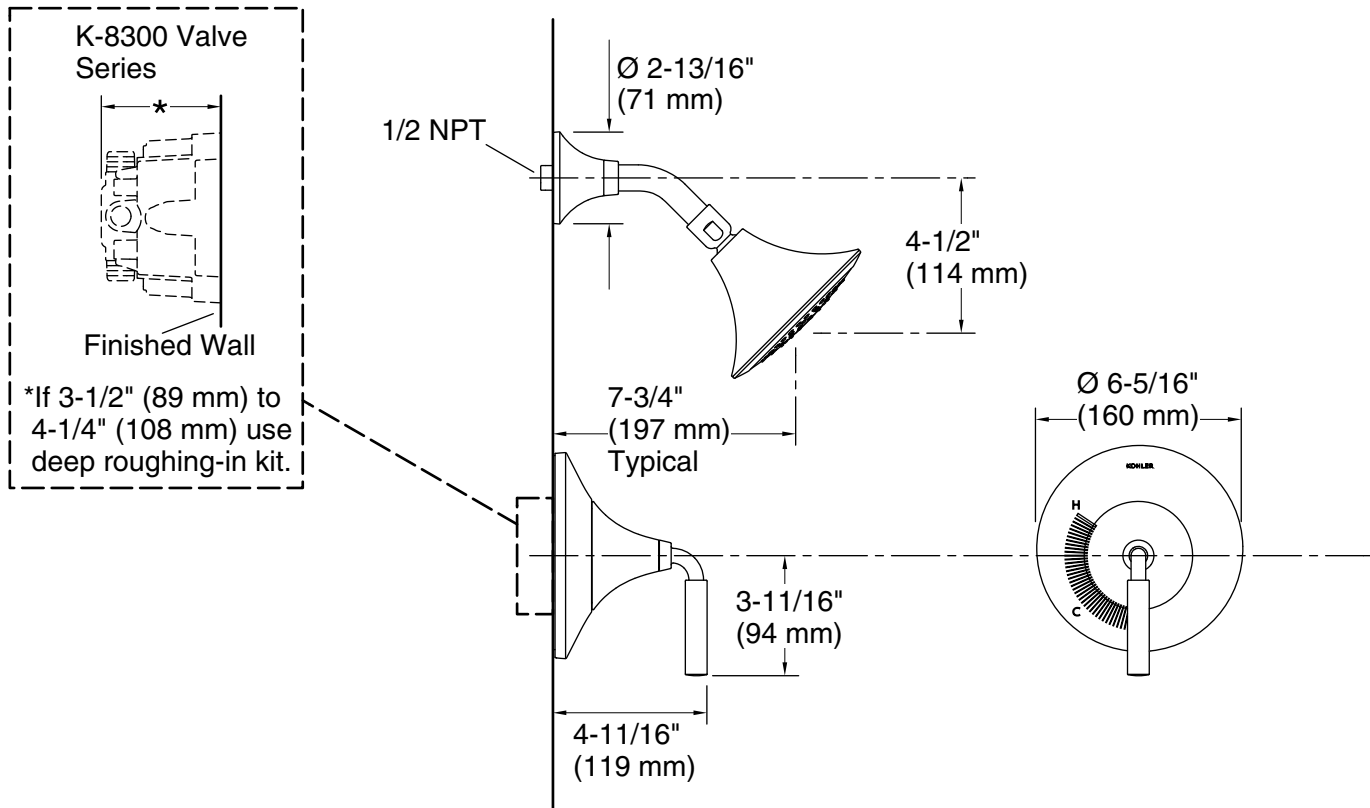

Technical Information

All product dimensions are nominal.

Drain included: No

Showerhead/Body Spray:

Rated maximum flow: 2.5 gal/min (9.5 l/min)

Pressure: 45 psi (3.1 bar)

Notes

Install this product according to the installation instructions.