

Features

- Premium construction ensures durability and reliability

Recommended Products/Accessories

- K-23723 Faucet cleaner
- K-14375 24" Double Towel Bar
- K-14377 Pivoting toilet paper holder
- K-14435 18" Towel Bar
- K-14436 24" Towel Bar
- K-14441 Towel Ring
- K-14443 Robe Hook
- K-14444 Vertical toilet paper holder

Codes/Standards









ASME A112.18.1/CSA B125.1

KOHLER® Faucet Lifetime Limited Warranty

See website for detailed warranty information.

Available Colors/Finishes

Color tiles intended for reference only.

Color	Code	Description
	CP	Polished Chrome
	SN	Vibrant™ Polished Nickel
	AF	Vibrant™ French Gold
	BN	Vibrant™ Brushed Nickel
	BV	Vibrant™ Brushed Bronze
	BL	Matte Black
	2MB	Vibrant™ Brushed Moderne Brass
	RGD	Vibrant Rose Gold
	VHR	

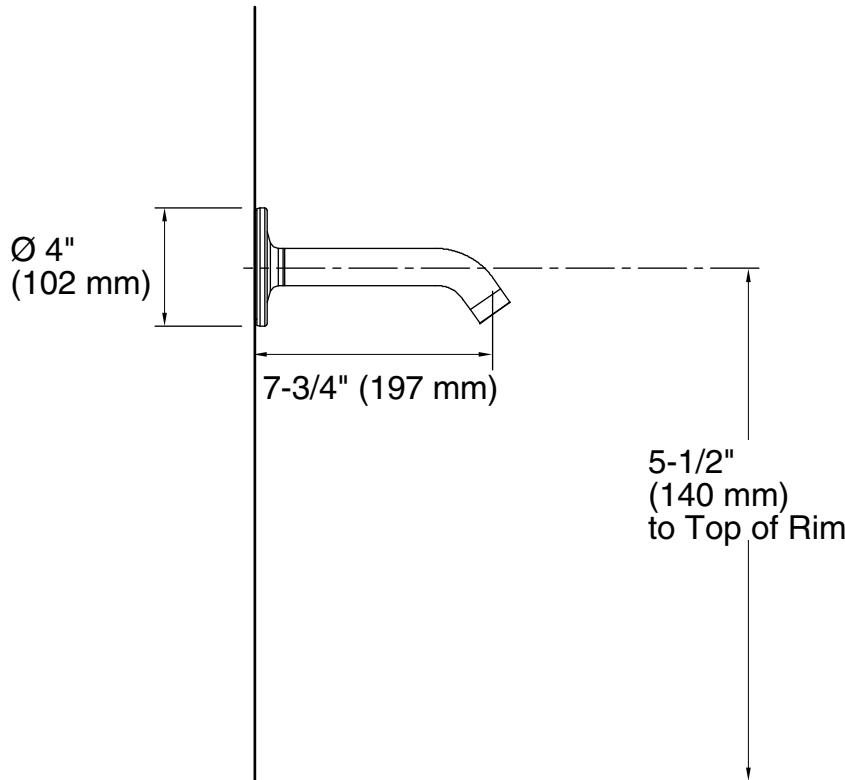

Technical Information

All product dimensions are nominal.

Showerhead/Body Spray:

Rated maximum flow: 2.5 gal/min (9.5 l/min)

Notes

Install this product according to the installation guide.