



Verdera®
15" x 30" rectangular medicine cabinet
K-35569-NFC

Features

- Front mirror, inside door mirror, and back panel mirror provide superior visibility to make grooming easier
- Three adjustable tempered-glass shelves offer additional bathroom storage
- Half-shelf adjustable accessory shelf for additional storage
- Hinges have 110° opening capability
- Box includes: Assembled mirrored cabinet, side panel kit, installation hardware

Material

- Anodized aluminum construction with a durable rustproof and chip-resistant finish
- KOHLER finishes resist corrosion and tarnishing

Installation

- Surface-mount or recessed
- Can be installed with left- or right-hand swing



Codes/Standards

None Applicable

**KOHLER® One-Year Limited
Warranty**

See website for detailed warranty information.

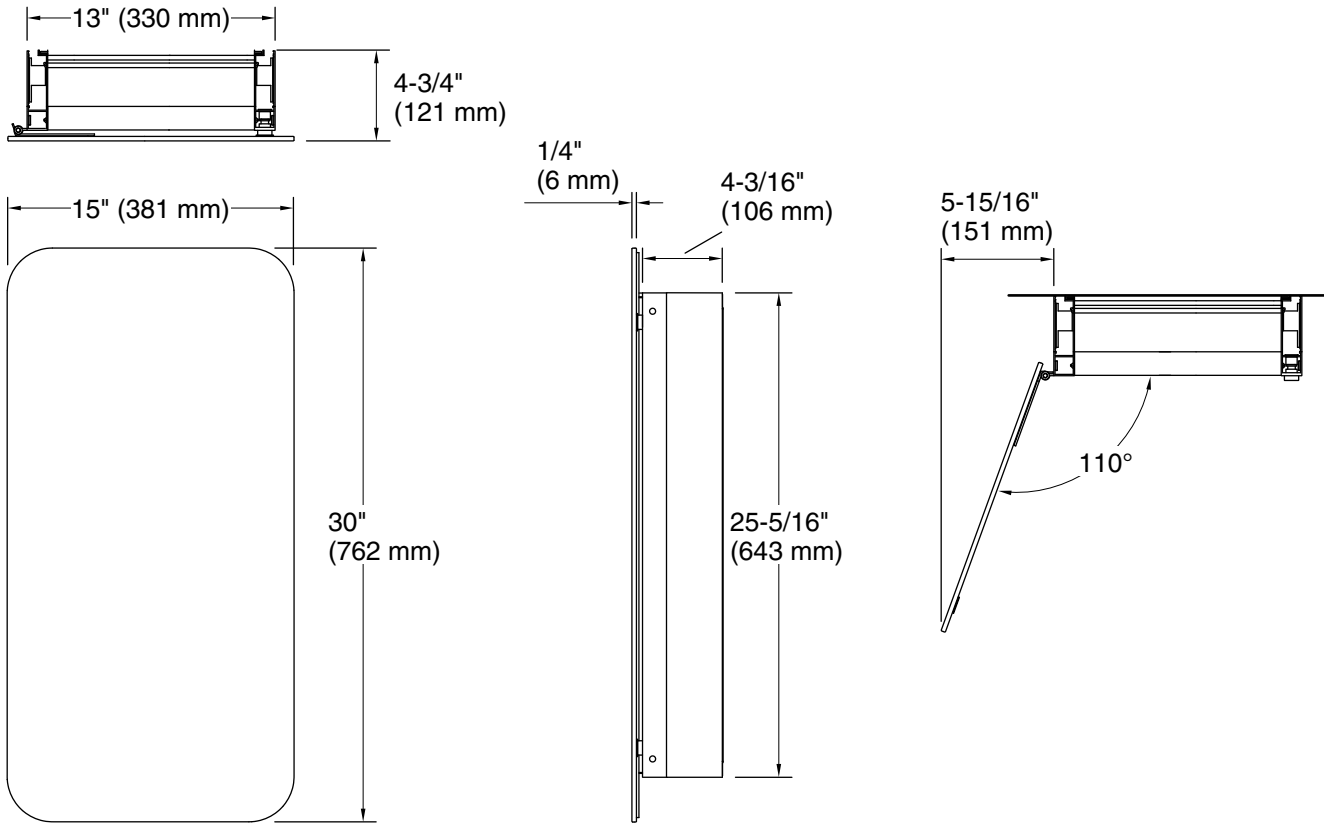

Technical Information

All product dimensions are nominal.

Lighting included: No

Notes

Install this product according to the installation instructions.