



OWNER'S MANUAL

# AIR CONDITIONER

---

Read this owner's manual thoroughly before operating the appliance and keep it handy for reference at all times.

**ENGLISH**

---

# TABLE OF CONTENTS

## 3 IMPORTANT SAFETY INSTRUCTIONS

---

### 3 READ ALL INSTRUCTIONS BEFORE USE

- 3 Safety Messages
- 4 Notes for Flammable Refrigerant

### 4 WARNING INSTRUCTIONS

- 4 Technical Safety
- 5 Installation
- 5 Power
- 6 Operation
- 7 Maintenance

### 7 CAUTION INSTRUCTIONS

- 7 Installation
- 8 Operation
- 9 Maintenance

### 9 NOTES FOR SAFETY GUIDE

- 9 Installation
- 11 Qualification of Workers
- 12 Wiring
- 12 Operation
- 13 Service and Installation
- 17 Caution

## 19 OPERATION

---

### 19 Before Use

- 19 Notes for Operation
- 19 Suggestions for Energy Saving

## 20 MAINTENANCE

---

### 20 Cleaning

- 20 Air Filter
- 20 Filter Care

### 21 Tips for Maintenance

- 21 Before Long Periods of Disuse
- 21 After Long Periods of Disuse

## 22 TROUBLESHOOTING

---

### 22 Before Calling for Service

- 22 Operation
- 24 Performance

### 25 Calling for Service

- 25 Situations in which Calling for Service is Necessary

## 26 LIMITED WARRANTY

---

### 26 USA

- 26 LIMITED WARRANTY(USA)

### 27 CANADA

- 27 LIMITED WARRANTY(CANADA)

# IMPORTANT SAFETY INSTRUCTIONS

## READ ALL INSTRUCTIONS BEFORE USE

### Safety Messages

**Your safety and the safety of others are very important.**

We have provided many important safety messages in this manual and on your appliance. Always read and follow all safety messages.



This is the safety alert symbol.

This symbol alerts you to potential hazards that can kill or injure you and others. All safety messages will follow the safety alert symbol and either the word WARNING or CAUTION.

These words mean:



### **WARNING**

You may be killed or seriously injured if you do not follow instructions.







### **CAUTION**

You may be injured or cause damage to the product if you do not follow instructions.

All safety messages will tell you what the potential hazard is, tell you how to reduce the chance of injury, and tell you what may happen if the instructions are not followed.

### Notes for Flammable Refrigerant

The following safety guidelines are intended to prevent unforeseen risks or damage from unsafe or incorrect operation of the appliance. The guidelines are separated into 'WARNING' and 'CAUTION' as described below.

|   |     |   |
|---|-----|---|
|  | A2L | This symbol indicates that this appliance uses a flammable refrigerant. If the refrigerant is leaked and exposed to an external ignition source, there is a risk of fire. |
|  | A2L |   |
|  |     | This symbol indicates that the Owner's Manual should be read carefully.   |
|  |     | This symbol indicates that service personnel should be handling this equipment with reference to the Installation Manual.   |
|  |     | This symbol indicates that information is available in the Owner's Manual or Installation Manual.   |

## WARNING INSTRUCTIONS

### WARNING

- To reduce the risk of explosion, fire, death, electric shock, injury or scalding to persons when using this product, follow basic precautions, including the following:
- 

### Technical Safety

- This appliance is not intended for use by persons (including children) with reduced physical, sensory or mental capabilities, or lack of experience and knowledge, unless they have been given supervision or instruction concerning use of the appliance by a person responsible for their safety. Children should be supervised to ensure that they do not play with the appliance.
- This appliance can be used by children aged from 8 years and above and persons with reduced physical, sensory or mental capabilities or lack of experience and knowledge if they have been given supervision or instruction concerning use of the appliance in a safe way and understand the hazards involved. Children shall not play with the appliance. Cleaning and user maintenance shall not be made by children without supervision.
- Installation or repairs made by unauthorized persons can pose hazards to you and others.
- The information contained in the manual is intended for use by a qualified service technician who is familiar with the safety procedures and equipped with the proper tools and test instruments.
- Failure to read and follow all instructions in this manual can result in equipment malfunction, property damage, personal injury and/or death.
- The refrigerant and insulation blowing gas used in the appliance require special disposal procedures. Consult a service agent or a similarly qualified person before disposing of them.
- When the power cord is to be replaced, the replacement work shall be performed by authorized personnel using only genuine replacement parts.
- If the supply cord is damaged, it must be replaced by the manufacturer or its service agents or a similarly qualified person in order to avoid a hazard.
- The appliance shall be installed in accordance with national wiring regulations.
- This appliance must be properly grounded.
- Do not cut or remove the grounding prong from the power plug.
- Attaching the earth wire to the power outlet cover screw does not ground the appliance unless the cover screw is metal, uninsulated, and the power outlet is grounded through house wiring.

- If you have any doubt whether the air conditioner is properly grounded, have the power outlet and circuit checked by a qualified electrician.
- Installation MUST conform to the local building codes or, in the absence of local codes, the National Electrical Code NFPA 70/ANSI C1-1003 or current edition and Canadian Electrical Code Part1 CSA C.22. 1.

## Installation

- Contact the dealer to have the air conditioner installed.
  - Incomplete installation performed by yourself may result in a water leakage, electric shock, and fire.
- Check the foundation for damaged on a continuous basis, especially if it has been in use for a long time.
  - It may cause injury or damage to the unit or other property.
- Contact the dealer for repairs, maintenance and to reinstall the air conditioner.
  - Incomplete installation performed by yourself may result in a water leakage, electric shock, and fire.
- Be sure to only use accessories made by LG which are specifically designed for use with the equipment and have them installed by a professional.
  - Improper installation or attachment of equipment or accessories could result in electric shock, a short circuit, leaks, fire or other damage to the equipment.
- In the case of refrigerant leakage, consult the dealer.

When installing the air conditioner in a small room, it is necessary to take proper measures so that even when it leaks, the amount of any leaked refrigerant does not exceed the limiting concentration even when it leaks.

If the refrigerant leakage exceeds the limiting concentration level, an oxygen deficiency related accident may occur.

- There is a risk of asphyxiation which could lead to serious injury or death.
- Do not install the unit in an area where there are flammable materials.
  - There is a risk of explosion that could result in serious injury or death.
- Use a vacuum pump or insert (nitrogen) gas when performing a leakage test or air purge. Do not allow air etc. to enter the refrigerant circuit (piping). Never use refrigerants that are not specified on the specification. label and in the manuals.
  - There is a risk of death, injury, fire or explosion.
- For installation of the UVnano Filter Box(a non integral duct mounted UV lamp system approved by LG Electronics), always contact the service center or a professional installation agency.
  - Otherwise, it may cause a ultraviolet(UV) radiation exposure to eyes and skins, electrical shock, or injury.
- Do not install indoor units in laundry rooms.
- All communication and power wiring must be connected to the terminals using UL certified connector.

## Power

- Do not attempt to do electrical work or grounding work unless you are licensed to do so. Consult with the dealer for electrical work and grounding work.
  - There is a risk.
- Do not modify or extend the power cable.
  - There is risk of fire or electric shock.
- Be sure to establish an earth.
  - There is risk of fire or electric shock.
- Be sure to install an earth leakage breaker.
  - There is risk of fire or electric shock.

## 6 IMPORTANT SAFETY INSTRUCTIONS

---

- Always install a dedicated circuit and breaker.
  - Improper wiring or installation may cause fire or electric shock.
- Do not turn on the breaker or power if the front panel, cabinet, top cover, or control box cover are removed or opened.
  - Doing so could cause fire, electric shock, explosion or death.
- Do not use a defective or underrated circuit breaker. Use this appliance on a dedicated circuit.
  - There is a risk of fire or electric shock.
- Consult with the installation contractor for cleaning or maintenance. Turn off all electrical power before doing any cleaning or maintenance.
  - There is a risk of water leakage, electric shock or serious injury.
- Take care to ensure that the power cable cannot be pulled out or damaged during operation.
  - There is a risk of fire or electric shock.
- Do not place anything on the power cable.
  - There is a risk of fire or electric shock.
- Do not turn off the power immediately after stopping operation. Always wait for at least five minutes before turning off the power.
  - Otherwise, water leakage may occur.
- Indoor/outdoor wiring connections must be secured tightly and the cable should be routed properly so that there is no force pulling the cable from the connection terminals.
  - Improper or loose connections can cause heat generation or fire.
- Do not touch (operate) the product with wet hands.
  - There is a risk of electrical shock.
- When installing the product vertical standing position, vertical drain pan(accessory kit) must be installed.
  - Otherwise, drain water leakage will occur and can cause hazardous damage.

### Operation

- Be sure to use only those parts which are listed in the SVC parts list. Never attempt to modify the equipment.
  - The use of inappropriate parts can cause an electrical shock or fire.
- Do not install the air conditioner at any place where flammable gas may leak out. If the gas leaks out and stays around the air conditioner, a fire may break out.
  - There is a risk of explosion, fire and serious injury.
- Never use flammable spray such as hair spray, lacquer or paint near the unit.
  - Flammable spray may cause a fire.
- If equipment utilizing a burner is used in the same room as the air conditioner, there is the danger of oxygen deficiency, which could lead to asphyxiation. Be sure to ventilate the room sufficiently to avoid this hazard.
  - There is a risk of serious injury or death.
- Do not put fingers or other objects into the air inlet or air outlet. Never remove the fan guard of the unit.
  - The fan rotates at a high speed and will cause injury.
- Never sprinkle or spill water or liquids on unit.
  - Doing so could cause fire, failure of the product, or electric shock.
- Never let the indoor unit or the remote controller get wet.
  - Water can cause an electric shock or a fire.

- Do not let the air conditioner run while a door or window is open on a day with high humidity. This could result in excessive moisture and water damage.
  - Excess moisture may collect and cause water damage to walls or furniture.
- If there are any abnormalities in the operation of the air conditioner such as strange sounds, smoke or fire. turn off the power and contact the dealer immediately.
  - There is a risk of severe injury or death.
- Take care to ensure that nobody can step on or fall onto the outdoor unit.
  - This could result in personal injury and product damage.
- Stop operation and close all window in storm or hurricane. If possible, remove the product from the window before the hurricane arrives.
  - There is a risk of property damage, product failure, or electric shock.
- If the product becomes soaked (flooded or submerged), contact the dealer.
  - There is a risk of fire or electric shock.
- Do not use the product in a tightly closed space for a long time.
  - Doing so could result in a state of oxygen deficiency.

## Maintenance

The heat exchanger fins are sharp edges enough to cut. To avoid injury, wear gloves or cover the fins while working around them.

- Tear apart and throw away plastic packaging bags so that children will not play with them.
  - Children playing with plastic bags are at risk of death by suffocation.
- Safely dispose of the packing materials. Packing materials, such as nails and other metal or wooden parts.
  - These materials could cause puncture wounds or other injuries.

## CAUTION INSTRUCTIONS

### CAUTION

- To reduce the risk of minor injury to persons, malfunction, or damage to the product or property when using this product, follow basic precautions, including the following:

## Installation

- If the refrigerant gas leaks during the installation, ventilate the area immediately.
  - Such leakage it can be harmful for your health.
- Always check for gas (refrigerant) leakage after installation or repair of product.
  - Low refrigerant levels may cause product failure.
- Keep the product level, even when installing it.
  - This will help to avoid vibration or water leakage.
- Use two or more people to lift and transport the product.
  - This will help to avoid personal injury.
- Installation work must be performed in accordance with the National Electric Code by qualified and authorized personnel only.
- Do not place objects in direct proximity of the outside unit. Do not let leaves and other debris accumulate around the unit. Leaves are a hotbed for small animals, which can enter the unit. Once inside

## 8 IMPORTANT SAFETY INSTRUCTIONS

---

the unit, these animals can lead to the unit malfunctioning, and end up causing in smoke or fire when they make contact with electrical parts.

- There is a risk of fire or electric shock.
- Do not install the product where it will be exposed to sea wind (salt spray) directly.
  - This can cause corrosion on the product. Corrosion, particularly on the condenser and evaporator fins, could cause product malfunction or inefficient operation.
- Make sure that the drainpipe is installed properly to drain water. Arrange the drain hose to ensure smooth drainage.
  - Incomplete drainage may lead to water damage done to the building, furniture, etc. If no water is discharged from the drainpipe while the air conditioner or heat pump is in the cooling mode, it may be because the drainpipe has become clogged with dust or dirt, and could result in water leakage in the indoor unit. In such a situation, stop operating the air conditioner or heat pump and contact the dealer.
- Do not install the product where the noise or hot air from the outdoor unit could be harmful to your immediate surroundings.
  - Improper placement could cause problems for your neighbors.
- The Limited Warranty is void and of no effect, and LG will have no liability hereunder to any Customer or third party, to the extent any of the following occur: acts, omissions, and conduct of any and all third parties including, but not limited to, the installing contractor and any repairs, service or maintenance by unauthorized or unqualified persons.
- Do not install the unit in potentially explosive atmospheres.

### Operation

- If refrigerant gas leaks while the unit is being repaired do not touch the leaking refrigerant gas.
  - The refrigerant gas can cause frostbite (cold burn).
- Do not mix air or gases other than the specified refrigerant used in the system.
  - Air entering the refrigerant system can lead to excessively high pressure causing equipment damage or injury.
- Make sure that there are no obstacles close to the outdoor unit. The presence of obstacles close to the outdoor unit may reduce the performance of outdoor unit or increase its operating sound.
  - This could cause product failure.
- Do not use the air conditioner for any other purposes other than comfort cooling or heating. Do not use the unit for cooling precision instruments, food, plants, animals or works of art.
  - Doing so could lead to risk of damage or loss of property.
- Replace all the batteries in the remote control with new ones of the same type. Do not mix old and new batteries or different types of batteries.
  - Doing so could lead to a risk of fire or explosion.
- Do not recharge or disassemble the batteries. Do not dispose of batteries in a fire.
  - They may burn or explode.
- If the liquid from the batteries gets onto your skin or clothes, wash it well with clean water. Do not use the remote if the batteries have leaked.
  - The chemicals in batteries could cause burns or other health hazards.
- If you ingest the liquid from the batteries, brush your teeth and see a doctor. Do not use the remote if the batteries have leaked.
  - The chemicals in batteries could cause burns or other health hazards.
- Do not step on or put anything on the product. (outdoor units)
  - Doing so could lead to a risk of personal injury and product failure.
- The appliance is not intended for use by young children or infirm persons without supervision.

- Do not allow a child to mount on the unit or place any object on it. Do not let children play on and around the unit.
  - Falling or tumbling may result in injury. If a child touches the unit carelessly, it may result in injury.
- Do not drink the water drained from the product.
  - It is not sanitary and could cause serious health issues.

## Maintenance

- Contact the dealer for repair or maintenance.
- Do not wipe the controller operation panel with benzine, thinner, chemical dust cloths, etc. The panel may get discolored or the coating may peel off. If it is very dirty, soak a cloth in water-diluted neutral detergent, squeeze it well and wipe the panel clean. Then wipe it dry it with another dry cloth.
  - There is a risk of damage to the plastic parts of the product.
- Do not insert hands or other objects through the air inlet or outlet while the product is operating.
  - There are sharp and moving parts that could cause personal injury.
- Use a firm stool or ladder when cleaning or maintaining the product.
  - Be careful and avoid personal injury.
- Do not touch the metal parts of the product when removing the air filter. They are very sharp!
  - There is a risk of personal injury.
- Do not drink the water drained from the product.
  - It is not sanitary and could cause serious health issues.
- Do not operate the air conditioner when using a room fumigation-type insecticide.
  - Failure to do so could lead to the chemicals becoming deposited in the unit, which could endanger the health of those who are hypersensitive to chemicals.

## NOTES FOR SAFETY GUIDE

### Installation

- Always perform grounding.
  - Otherwise, it may cause electrical shock.
- For installation of the product, always contact the service center or a professional installation agency.
  - Otherwise, it may cause a fire, electrical shock, explosion or injury.
- Securely attach the electrical part cover to the indoor unit and the service panel to the outdoor unit.
  - If the electrical part cover of the indoor unit and the service panel of the outdoor unit are not attached securely, it could result in a fire or electric shock due to dust, water, etc.
- Always install an air leakage breaker and a dedicated switching board.
  - No installation may cause a fire and electrical shock.
- Do not keep or use flammable gases or combustibles near the air conditioner.
  - Otherwise, it may cause a fire or the failure of product.
- Ensure that an installation frame of the outdoor unit is not damaged due to use for a long time.
  - It may cause injury or an accident.
- Do not disassemble or repair the product randomly.
  - It will cause a fire or electrical shock.
- Do not install the product at a place that there is concern of falling down.
  - Otherwise, it may result in personal injury.

## 10 IMPORTANT SAFETY INSTRUCTIONS

---

- Use caution when unpacking and installing.
  - Sharp edges may cause injury.
- Use a vacuum pump or Inert (nitrogen) gas when doing leakage test or air purge. Do not compress air or Oxygen and Do not use Flammable gases. Otherwise, it may cause fire or explosion. There is the risk of death, injury, fire or explosion.
  - Consult your local dealer regarding what to do in case of refrigerant leakage. When the air conditioner is to be installed in a small room, it is necessary to take proper measures so that the amount of any leaked refrigerant does not exceed the concentration limit in the event of a leakage. Otherwise, this may lead to an accident due to oxygen depletion.
- Carry out the specified installation work after taking into account earthquakes. Failure to do so during installation work may result in the unit falling and causing accidents.
- Make sure that a separate power supply circuit is provided for this unit and that all electrical work is carried out by qualified personnel according to local laws and regulations and this installation manual. An insufficient power supply capacity or improper electrical construction may lead to electric shocks or fire.
- Be sure to switch off the unit before touching any electrical parts.
- Make sure that all wiring is secured, the specified wires are used, and that there is no strain on the terminal connections or wires.
- If refrigerant gas leaks during installation, ventilate the area immediately. Toxic gas may be produced if the refrigerant gas comes into contact with fire.
- Make sure to be materials in a compartment handling air for circulation through a duct supplying only one room.
- Do not store or use flammable gas or combustibles near the unit.
  - There is risk of fire, explosion, and physical injury or death.
- Do not use means to accelerate the defrosting process or to clean, other than those recommended by the manufacturer.
- The appliance shall be stored in a room without continuously operating ignition sources. (For example: open flames, an operating gas appliance or an operating electric heater.)
- Do not pierce or burn.
- Be aware that refrigerants may not contain an odour.
- The manufacturer may provide other suitable examples or may provide additional information about the refrigerant odour.
- Pipe-work including, pipe routing, and installation shall include protection from physical damage in operation and service, and be in compliance with national and local codes and standards, such as ASHRAE 15, ASHRAE 15.2, IAPMO Uniform Mechanical Code, ICC International Mechanical Code, or CSA B52. All field joints shall be accessible for inspection prior to being covered or enclosed.
- An unventilated area where the appliance using flammable refrigerants is installed shall be so constructed that should any refrigerant leak, it will not stagnate so as to create a fire or explosion hazard.
- Field-made refrigerant joints indoors shall be tightness tested. The test method shall have a sensitivity of 5 grams per year of refrigerant or better under a pressure of at least 0,25 times the maximum allowable pressure. No leak shall be detected;
- If appliances connected via an air duct system to one or more rooms with A2L REFRIGERANTS are installed in a room with an area less than  $A_{min}$  as determined in standard, that room shall be without continuously operating open flames (e.g. an operating gas appliance) or other POTENTIAL IGNITION SOURCES (for e.g., an operating electric heater, hot surfaces). A flame-producing device may be installed in the same space if the device is provided with an effective flame arrest.
- After completion of field piping for split systems, the field pipework shall be pressure tested with an inert gas and then vacuum tested prior to refrigerant charging, according to the following requirements:
  - The minimum test pressure for the low side of the system shall be the low side design pressure and the minimum test pressure for the high side of the system shall be the high side design pressure,

unless the high side of the system, cannot be isolated from the low side of the system in which case the entire system shall be pressure tested to the low side design pressure.

- The test pressure after removal of pressure source shall be maintained for at least 1 h with no decrease of pressure indicated by the test gauge, with test gauge resolution not exceeding 5% of the test pressure.
- During the evacuation test, after achieving a vacuum level specified in the manual or less, the refrigeration system shall be isolated from the vacuum pump and the pressure shall not rise above 1500 microns within 10 min. The vacuum pressure level shall be specified in the manual, and shall be the lessor of 500 microns or the value required for compliance with national and local codes and standards, which may vary between residential, commercial, and industrial buildings.

## Qualification of Workers

The manual shall contain specific information about the required qualification of the working personnel for maintenance, service and repair operations. Every working procedure that affects safety means shall only be carried out by qualified person by manufacturer.

- Examples for such working procedures are:
  - Breaking into the refrigerating circuit;
  - Opening of sealed components;
  - Opening of ventilated enclosures.
- Refrigerant tubing shall be protected or enclosed to avoid damage.
- Flexible refrigerant connectors (such as connecting lines between the indoor and outdoor unit) that may be displaced during normal operations shall be protected against mechanical damage.
- A brazed, welded, or mechanical connection shall be made before opening the valves to permit refrigerant to flow between the refrigerating system parts.
- Keep any required ventilation openings clear of obstruction.
- Mechanical connections (mechanical connectors or flared joints) shall be accessible for maintenance purposes.
- Flexible pipe elements shall be protected against mechanical damage, excessive stress by torsion, or other forces. They should be checked for mechanical damage annually.
- Protection devices, piping and fittings shall be protected as far as possible against adverse environmental effects, for example, the danger of water collecting and freezing in relief pipes or the accumulation of dirt and debris.
- Precautions shall be taken to avoid excessive vibration or pulsation to refrigerating piping.
- Piping in refrigerating systems shall be so designed and installed to minimize the likelihood hydraulic shock damaging the system.
- Provision shall be made for expansion and contraction of long runs of piping.
- Steel pipes and components shall be protected against corrosion with a rustproof coating before applying any insulation.
- Ducts connected to an appliance shall not contain a potential ignition source.
- The supply and return air shall be directly ducted to the space.
- Open areas such as false ceilings shall not be used as a return air duct.
- Only auxiliary devices approved by the appliance manufacturer or declared suitable with the refrigerant shall be installed in connecting ductwork.
- Auxiliary devices which can be potential ignition source shall not be installed in connecting ductwork. Examples of potential ignition sources are UV lights, electric heaters with a temperature exceeding 700 °C, pilot flames, brushed motors and similar devices.
- For duct connected appliances, false ceilings or drop ceilings may be used as a return air plenum if a REFRIGERANT DETECTION SYSTEM is provided in the appliance and any external connections are also provided with a sensor immediately below the return air plenum duct joint.

### Wiring

- High voltage electricity is required to operate this system. Adhere to applicable building codes: National Electrical Code (NEC) for U.S. and Mexico, Canada Electrical Code (CE) for Canada and these instructions when wiring.
  - Improper connections and inadequate grounding can cause accidental injury or death.
- Always ground the unit following local, state, and national Codes.
  - There is risk of fire, electric shock, and physical injury or death.
- Properly size all circuit breakers or fuses.
  - There is risk of fire, electric shock, explosion, physical injury or death.
- The information contained in this manual is intended for use by an industry-qualified, experienced, certified electrician familiar with NEC for U.S. and Mexico, or CE for Canada who is equipped with the proper tools and test instruments.
  - Failure to carefully read and follow all instructions in this manual can result in equipment malfunction, property damage, personal injury or death.
- Refer to local, state, and federal codes, and use power wires of sufficient current capacity and rating.
  - Wires that are too small may generate heat and cause a fire.
- All electric work must be performed by a licensed electrician and conform to local building codes or, in the absence of local codes, with NEC for U.S. and Mexico, or CE for Canada, and the instructions given in this manual.
  - If the power source capacity is inadequate or the electric work is not performed properly, it may result in fire, electric shock, physical injury or death.
- Secure all field wiring connections with appropriate wire strain relief.
  - Improperly securing wires will create undue stress on equipment power lugs. Inadequate connections may generate heat, cause a fire and physical injury or death.
- Properly tighten all power lugs.
  - Loose wiring may overheat at connection points, causing a fire, physical injury or death.
- Do not change the settings of the protection devices.
  - If the pressure switch, thermal switch, or other protection devices are bypassed or forced to work improperly, or parts other than those specified by LG are used, there is risk of fire, electric shock, explosion, and physical injury or death.
- The appliance shall be installed in accordance with national wiring regulations.
- Means for disconnection must be incorporated in the fixed wiring in accordance with the wiring rules.
- If the supply cord is damaged, it must be replaced by the manufacturer, its service agent or similarly qualified persons in order to avoid a hazard.

---

### NOTE

- Do not supply power to the unit until all electrical wiring, controls wiring, piping, installation, and refrigerant system evacuation are completed.
- 

### Operation

- Unplug the unit if strange sounds, smell, or smoke comes from it.
  - Otherwise, it may cause electrical shock or a fire.
- Keep the flames away.
  - Otherwise, it may cause a fire.
- Take the power plug out if necessary, holding the head of the plug and do not touch it with wet hands.
  - Otherwise, it may cause a fire or electrical shock.

- Do not open the suction inlet of the indoor/outdoor unit during operation.
  - Otherwise, it may electrical shock and failure.
- Do not allow water to run into electrical parts.
  - Otherwise, it may cause the failure of machine or electrical shock.
- Never touch the metal parts of the unit when removing the filter.
  - They are sharp and may cause injury.
- Do not step on the indoor/outdoor unit and do not put anything on it.
  - It may cause an injury through dropping of the unit or falling down.
- When the product is submerged into water, always contact the service center.
  - Otherwise, it may cause a fire or electrical shock.
- Take care so that children may not step on the outdoor unit.
  - Otherwise, children may be seriously injured due to falling down.
- The appliance shall be stored so as to prevent mechanical damage from occurring.
- This appliance is not intended for use by persons (including children) with reduced physical, sensory or mental capabilities or lack of experience and knowledge, unless they have been given supervision or instruction concerning use of the appliance by a person responsible for their safety. Children should be supervised to ensure that they do not play with the appliance.
- LEAK DETECTION SYSTEM installed. Unit must be powered except for service. This unit is equipped with a refrigerant leak detector for safety. To be effective, the unit must be electrically powered at all times after installation, other than when servicing.

## Service and Installation

### Checks to the area

Prior to beginning work on systems containing flammable refrigerants, safety checks are necessary to ensure that the risk of ignition is minimized. For repair to the refrigerating system, the following precautions shall be complied with prior to conducting work on the system.

### Work procedure

Work shall be undertaken under a controlled procedure so as to minimize the risk of a flammable gas or vapour being present while the work is being performed.

### General work area

All maintenance staff and others working in the local area shall be instructed on the nature of work being carried out. Work in confined spaces shall be avoided.

### Checking for presence of refrigerant

The area shall be checked with an appropriate refrigerant detector prior to and during work, to ensure the technician is aware of potentially flammable atmospheres. Ensure that the leak detection equipment being used is suitable for use with flammable refrigerants, i.e. non-sparking, adequately sealed or intrinsically safe.

### Presence of fire extinguisher

If any hot work is to be conducted on the refrigerating equipment or any associated parts, appropriate fire extinguishing equipment shall be available to hand. Have a dry powder or CO<sub>2</sub> fire extinguisher adjacent to the charging area.

## 14 IMPORTANT SAFETY INSTRUCTIONS

---

### No ignition sources

No person carrying out work in relation to a refrigerating system which involves exposing any pipe work shall use any sources of ignition in such a manner that it may lead to the risk of fire or explosion.

All possible ignition sources, including cigarette smoking, should be kept sufficiently far away from the site of installation, repairing, removing and disposal, during which refrigerant can possibly be released to the surrounding space. Prior to work taking place, the area around the equipment is to be surveyed to make sure that there are no flammable hazards or ignition risks. "No Smoking" signs shall be displayed.

### Ventilated area

Ensure that the area is in the open or that it is adequately ventilated before breaking into the system or conducting any hot work. A degree of ventilation shall continue during the period that the work is carried out.

The ventilation should safely disperse any released refrigerant and preferably expel it externally into the atmosphere.

### Checks to the refrigerating equipment

Where electrical components are being changed, they shall be fit for the purpose and to the correct specification.

At all times the manufacturer's maintenance and service guidelines shall be followed. If in doubt consult the manufacturer's technical department for assistance.

The following checks shall be applied to installations using flammable refrigerants:

- The actual refrigerant charge is in accordance with the room size within which the refrigerant containing parts are installed
- The ventilation machinery and outlets are operating adequately and are not obstructed
- If an indirect refrigerating circuit is being used, the secondary circuit shall be checked for the presence of refrigerant
- Marking to the equipment continues to be visible and legible. Markings and signs that are illegible shall be corrected
- Refrigerating pipe or components are installed in a position where they are unlikely to be exposed to any substance which may corrode refrigerant containing components, unless the components are constructed of materials which are inherently resistant to being corroded or are suitably protected against being so corroded.

### Checks to the area

Repair and maintenance to electrical components shall include initial safety checks and component inspection procedures. If a fault exists that could compromise safety, then no electrical supply shall be connected to the circuit until it is satisfactorily dealt with. If the fault cannot be corrected immediately but it is necessary to continue operation, an adequate temporary solution shall be used. This shall be reported to the owner of the equipment so all parties are advised.

Initial safety checks shall include:

- Capacitors are discharged: this shall be done in a safe manner to avoid possibility of sparking.
- No live electrical components and wiring are exposed while charging, recovering or purging the system.
- Continuity of earth bonding

### Repairs to sealed components

Sealed electrical components shall be replaced.

### Repair to intrinsically safe components

Intrinsically safe components must be replaced.

## Cabling

Check that cabling will not be subject to wear, corrosion, excessive pressure, vibration, sharp edges or any other adverse environmental effects. The check shall also take into account the effects of aging or continual vibration from sources such as compressors or fans.

## Detection of flammable refrigerants

Under no circumstances shall potential sources of ignition be used in the searching for or detection of refrigerant leaks. A halide torch (or any other detector using a naked flame) shall not be used.

## Leak detection methods

The following leak detection methods are deemed acceptable for all refrigerant systems.

Electronic leak detectors may be used to detect refrigerant leaks but, in the case of FLAMMABLE REFRIGERANTS, the sensitivity may not be adequate, or may need re-calibration. (Detection equipment shall be calibrated in a refrigerant-free area.) Ensure that the detector is not a potential source of ignition and is suitable for the refrigerant used. Leak detection equipment shall be set at a percentage of the LFL of the refrigerant and shall be calibrated to the refrigerant employed, and the appropriate percentage of gas (25 % maximum) is confirmed.

Leak detection fluids are also suitable for use with most refrigerants but the use of detergents containing chlorine shall be avoided as the chlorine may react with the refrigerant and corrode the copper pipe-work.

## NOTE

- Examples of leak detection fluids are.
  - Bubble method.
  - Fluorescent method agents.

If a leak is suspected, all naked flames shall be removed / extinguished.

If a leakage of refrigerant is found which requires brazing, all of the refrigerant shall be recovered from the system, or isolated (by means of shut off valves) in a part of the system remote from the leak. Removal of refrigerant shall be according to removal and evacuation procedure.

## Removal and evacuation

When breaking into the refrigerant circuit to make repairs or for any other purpose conventional procedures shall be used. However, for flammable refrigerants it is important that best practice be followed, since flammability is a consideration.

The following procedure shall be adhered to:

- Safely remove refrigerant following local and national regulations;
- Evacuate;
- Purge the circuit with inert gas (optional for A2L);
- Evacuate (optional for A2L);
- Continuously flush or purge with inert gas when using flame to open circuit; and
- Open the circuit.

The refrigerant charge shall be recovered into the correct recovery cylinders if venting is not allowed by local and national codes. For appliances containing flammable refrigerants, the system shall be purged with oxygen-free nitrogen to render the appliance safe for flammable refrigerants. This process might need to be repeated several times.

Compressed air or oxygen shall not be used for purging refrigerant systems.

For appliances containing flammable refrigerants, refrigerants purging shall be achieved by breaking the vacuum in the system with oxygen-free nitrogen and continuing to fill until the working pressure is achieved, then venting to atmosphere, and finally pulling down to a vacuum (optional for A2L). This process shall be repeated until no refrigerant is within the system (optional for A2L). When the final oxygen

free nitrogen charge is used, the system shall be vented down to atmospheric pressure to enable work to take place.

The outlet for the vacuum pump shall not be close to any potential ignition sources, and ventilation shall be available.

### Charging procedures

In addition to conventional charging procedures, the following requirements shall be followed.

- Ensure that contamination of different refrigerants does not occur when using charging equipment. Hoses or lines shall be as short as possible to minimize the amount of refrigerant contained in them.
- Cylinders shall be kept in an appropriate position according to the instruction.
- Ensure that the refrigerating system is earthed prior to charging the system with refrigerant.
- Label the system when charging is complete (if not already).
- Extreme care shall be taken not to overfill the refrigerating system.

Prior to recharging the system, it shall be pressure tested with the appropriate purging gas.

The system shall be leak-tested on completion of charging but prior to commissioning. A follow up leak test shall be carried out prior to leaving the site.

### Decommissioning

Before carrying out this procedure, it is essential that the technician is completely familiar with the equipment and all its detail.

It is recommended good practice that all refrigerants are recovered safely.

Prior to the task being carried out, an oil and refrigerant sample shall be taken in case analysis is required prior to re-use of recovered refrigerant.

It is essential that electrical power is available before the task is commenced.

- a) Become familiar with the equipment and its operation.
- b) Isolate system electrically.
- c) Before attempting the procedure ensure that:
  - Mechanical handling equipment is available, if required, for handling refrigerant cylinders
  - All personal protective equipment is available and being used correctly
  - The recovery process is supervised at all times by a competent person
  - Recovery equipment and cylinders conform to the appropriate standards.
- d) Pump down refrigerant system, if possible.
- e) If a vacuum is not possible, make a manifold so that refrigerant can be removed from various parts of the system.
- f) Make sure that cylinder is situated on the scales before recovery takes place.
- g) Start the recovery machine and operate in accordance with instructions.
- h) Do not overfill cylinders. (No more than 80 % volume liquid charge).
- i) Do not exceed the maximum working pressure of the cylinder, even temporarily.
- j) When the cylinders have been filled correctly and the process completed, make sure that the cylinders and the equipment are removed from site promptly and all isolation valves on the equipment are closed off.
- k) Recovered refrigerant shall not be charged into another refrigerating system unless it has been cleaned and checked.

### Labelling

Equipment shall be labelled stating that it has been de-commissioned and emptied of refrigerant.

The label shall be dated and signed.

Ensure that there are labels on the equipment stating the equipment contains flammable refrigerant.

## Recovery

When removing refrigerant from a system, either for servicing or decommissioning, it is recommended good practice that all refrigerants are removed safely.

When transferring refrigerant into cylinders, ensure that only appropriate refrigerant recovery cylinders are employed.

Ensure that the correct number of cylinders for holding the total system charge is available.

All cylinders to be used are designated for the recovered refrigerant and labelled for that refrigerant (i.e. special cylinders for the recovery of refrigerant).

Cylinders shall be complete with pressure-relief valve and associated shut-off valves in good working order.

Empty recovery cylinders are evacuated and, if possible, cooled before recovery occurs.

The recovery equipment shall be in good working order with a set of instructions concerning the equipment that is at hand and shall be suitable for the recovery of the flammable refrigerant.

If in doubt, the manufacturer should be consulted. In addition, a set of calibrated weighing scales shall be available and in good working order.

Hoses shall be complete with leak-free disconnect couplings and in good condition.

The recovered refrigerant shall be processed according to local legislation in the correct recovery cylinder, and the relevant waste transfer note arranged.

Do not mix refrigerants in recovery units and especially not in cylinders.

If compressor or compressor oils are to be removed, ensure that they have been evacuated to an acceptable level to make certain that flammable refrigerant does not remain within the lubricant.

The compressor body shall not be heated by an open flame or other ignition sources to accelerate this process.

When oil is drained from a system, it shall be carried out safely.

## Caution

### Installation

- Install the drain hose to ensure that drain can be securely done.
  - Otherwise, it may cause water leakage.
- Install the product so that the noise or hot wind from the outdoor unit may not cause any damage to the neighbors.
  - Otherwise, it may cause dispute with the neighbors.
- Always inspect gas leakage after the installation and repair of product.
  - Otherwise, it may cause the failure of product.
- Keep level parallel in installing the product.
  - Otherwise, it may cause vibration or water leakage.
- Do not install the unit in potentially explosive atmospheres.
- The installation of pipe-work shall be kept to a minimum.
- Any person who is involved with working on or breaking into a refrigerant circuit should hold a current valid certificate from an industry-accredited assessment authority, which authorises their competence to handle refrigerants safely in accordance with an industry recognised assessment specification.
- When mechanical connectors are reused indoors, sealing parts shall be renewed.
- When flared joints are reused indoors, the flare part shall be re-fabricated.

## 18 IMPORTANT SAFETY INSTRUCTIONS

---

### Operation

- Avoid excessive cooling and perform ventilation sometimes.
  - Otherwise, it may do harm to your health.
- Use a soft cloth to clean. Do not use wax, thinner, or a strong detergent.
  - The appearance of the air conditioner may deteriorate, change color, or develop surface flaws.
- Do not use an appliance for special purposes such as preserving animals vegetables, precision machine, or art articles.
  - Otherwise, it may damage your properties.
- Do not place obstacles around the flow inlet or outlet.
  - Otherwise, it may cause the failure of appliance or an accident.
- This appliance is not intended for the purposes of cooling INFORMATION TECHNOLOGY EQUIPMENT.
- Servicing shall only be performed as recommended by the equipment manufacturer. Maintenance and repair requiring the assistance of other skilled personnel shall be carried out under the supervision of the person competent in the use of flammable refrigerants.

### Service

- Servicing shall be performed only as recommended by the manufacturer.

**SAVE THESE INSTRUCTIONS**

---

# OPERATION

## Before Use

### Notes for Operation

- Speed up the fan to cool or warm indoor air quickly, within a short period of time.
- Turn off the appliance and periodically open windows for ventilation. The indoor air quality may deteriorate if the appliance is used for long periods.
- Clean the air filter once every 2 weeks. Dust and impurities collected in the air filter may block the airflow or reduce the appliance performance.

### Suggestions for Energy Saving

- Do not over-cool the space. This may be harmful to your health and may consume more electricity.
- Block sunlight with blinds or curtains while you are operating the appliance.
- Keep doors or windows closed tightly while you are operating the appliance.

# MAINTENANCE

## Cleaning

### Air Filter

**⚠ WARNING**

- Before cleaning or performing maintenance, disconnect the power supply and wait until the fan stops.
- When you remove the air filter, do not touch the metal parts of the indoor unit. Doing so may cause an injury.

Air filters must be purchased separately. Dirty filters greatly restrict the flow of air and may cause damage to the moving parts. If the filters become clogged the Electric Heaters and blower motor could overheat resulting in a potentially dangerous situation. The filters should be replaced at least once a month. On new construction, check the filters every week for the first four weeks and every three weeks after that, especially if the indoor fan is running continuously. When replacing the Filter you must use filters that are the same size as those recommended in Table.

| Platform<br>(Model)   | Capacity              | Disposable<br>Filter Size for<br>Bulit-in Filter<br>Compartment |
|---|-----------------------|---|
|   | Unit : kBtu/<br>h(RT) | Unit : Inch<br>(mm)   |
| NA<br>(ZRNU**3NAA<br>A)<br>** : 12, 18, 24,<br>30<br>(ZNNR**GAEA<br>0)<br>** : 12, 18, 24<br>(ZNNR**GAEH<br>0)<br>** : 18, 24<br>(ZMNR**GNAA<br>0)<br>** : 12, 18, 24 | 12 (1.0)              | 16 x 20 x 1 (406<br>x 508 x 25)                                 |
|   | 18 (1.5)              |   |
|   | 24 (2.0)              |   |
|   | 30 (2.5)              |   |

| Platform<br>(Model)   | Capacity              | Disposable<br>Filter Size for<br>Bulit-in Filter<br>Compartment |
|---|-----------------------|---|
|   | Unit : kBtu/<br>h(RT) | Unit : Inch<br>(mm)   |
| NB<br>(ZRNU**3NBA<br>A)<br>** : 36, 42, 48<br>(ZNNR**GBEA<br>0)<br>** : 30, 36<br>(ZNNR**GBEH<br>0)<br>** : 30, 36, 42,<br>48<br>(ZMNR**GNBA<br>0)<br>** : 30, 36 | 30 (2.5)              | 20 x 20 x 1 (508<br>x 508 x 25)                                 |
|   | 36 (3.0)              |   |
|   | 42 (3.5)              |   |
| NC<br>(ZRNU**3NCA<br>A)<br>** : 54, 60<br>(ZNNR60GCEA<br>0)   | 54 (4.5)              | 24 x 20 x 1 (610<br>x 508 x 25)                                 |
|   | 60 (5.0)              |   |

**NOTE**

- Filters should be used a rating of MERV 6 or less. If you use filters that has a rating MERV 7 or above, it can cause reduced cooling & heating capacity.

### Filter Care

Inspect the air filter every month. If dirty, wash reusable filters with a mild detergent. Replace disposable filters with new filters. Filters should be clean to assure maximum efficiency and adequate air circulation. Drapes, furniture or other obstructions blocking your supply and return air grilles will also decrease efficiency.

### Cleaning the Air Filter

Permanent type, washable, High-velocity filters may be cleaned with a vacuum cleaner or taken away from the unit & washed with a garden hose. Be sure to shake off excess water and allow filter to completely dry before re-installing the filter.

- 1 Before performing maintenance, turn off the power and check the fan to stop.
- 2 Slide the doors('A' & 'B') by pushing them to the opposite direction.

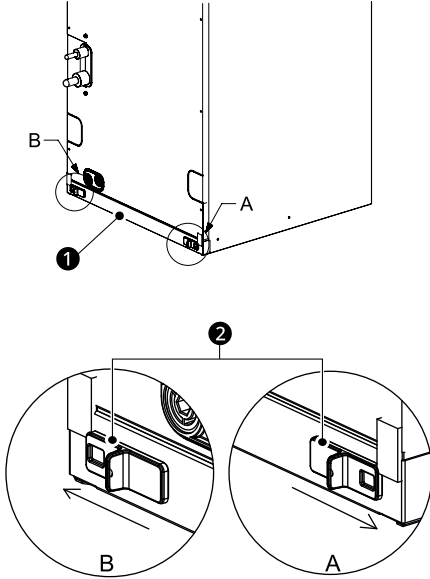

- ① Air Filter Cover
- ② Door

- 3 Remove the Air filter cover.

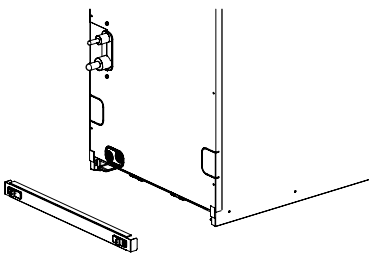

- 4 Take out the dirty filter or replace it with a new one.

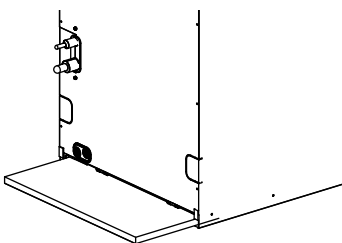

- 5 To assemble in reverse order.

## Tips for Maintenance

### Before Long Periods of Disuse

- 1 Operate the air conditioner in the **Fan mode** for 2 to 3 hours.
  - This will dry out the internal mechanisms.
- 2 Turn off the appliance.
- 3 Turn off the breaker.

### After Long Periods of Disuse

- 1 Clean the air filter and install it in the indoor unit.
- 2 Check that the air inlet and outlet of the indoor/outdoor unit are not blocked.
- 3 Check that the ground wire is connected correctly.
  - The ground wire may be connected to the side of the indoor unit.

# TROUBLESHOOTING

## Before Calling for Service

Please check the following before you contact the service center. If the problem persists, contact your local service center.

### NOTE

- Some functions may not be supported, depending on the model.

## Operation

| Problem                                      | Possible Cause & Solution   |
|--|---|
| <b>The appliance does not work normally.</b> | <b>Burning smell and strange sounds are coming from the appliance.</b> <ul style="list-style-type: none"> <li>• Turn off the appliance, switch off or disconnect the power supply, and contact a service center.</li> </ul>   |
|  | <b>Water leaks from the indoor unit even when the humidity level is low.</b> <ul style="list-style-type: none"> <li>• Turn off the appliance, switch off or disconnect the power supply, and contact a service center.</li> </ul>   |
|  | <b>The power cable is damaged or it is generating excessive heat.</b> <ul style="list-style-type: none"> <li>• Turn off the appliance, switch off or disconnect the power supply, and contact a service center.</li> </ul>  |
|  | <b>A switch, a circuit breaker (safety, ground) or a fuse is not operating properly.</b><br><b>Has the fuse blown or has the circuit breaker been tripped?</b> <ul style="list-style-type: none"> <li>• Turn off the appliance, switch off or disconnect the power supply, and contact a service center.</li> </ul>   |
|  | <b>The appliance generates an error code from its self-diagnosis.</b> <ul style="list-style-type: none"> <li>• Turn off the appliance, switch off or disconnect the power supply, and contact a service center.</li> </ul>  |
| <b>The fan speed cannot be adjusted.</b>     | <b>The Jet mode or Auto Operation mode is selected.</b> <ul style="list-style-type: none"> <li>• In some operating modes, you cannot adjust the fan speed. Select an operating mode in which you can adjust the fan speed.</li> </ul>   |
|  | <b>The airflow generated by the air conditioner may be automatically adjusted during operation.</b> <ul style="list-style-type: none"> <li>• When the air conditioner reaches the set temperature, it reduces the airflow rate to avoid generating cool airflow when heating, or to minimize energy consumption and indoor humidity change when cooling.</li> </ul> |
| <b>The temperature cannot be adjusted.</b>   | <b>The Fan mode or Jet mode is selected.</b> <ul style="list-style-type: none"> <li>• In some operating modes, you cannot adjust the temperature. Select an operating mode in which you can adjust the temperature.</li> </ul>  |
| <b>The appliance stops during operation.</b> | <b>The appliance is suddenly turned off.</b> <ul style="list-style-type: none"> <li>• The <b>Off Timer</b> function may have timed out, which turns the appliance off. Check the timer settings.</li> </ul>   |
|  | <b>Have you made a mistake in time operation?</b> <ul style="list-style-type: none"> <li>• Set the timer correctly.</li> </ul>  |
|  | <b>A power failure has occurred during operation.</b> <ul style="list-style-type: none"> <li>• Wait for the power to come back on. If you have the <b>Auto Restart</b> function enabled, your appliance will resume its last operation several minutes after power is restored.</li> </ul>  |

| Problem                                      | Possible Cause & Solution   |
|--|---|
| <b>The appliance does not work.</b>          | <b>A fuse blew or the power supply is blocked.</b> <ul style="list-style-type: none"> <li>• Replace the fuse or check if the circuit breaker has tripped.</li> </ul>  |
|  | <b>The appliance is unplugged.</b> <ul style="list-style-type: none"> <li>• Check whether the power cord is plugged into the outlet or the power isolators are switched on.</li> </ul>  |
|  | <b>A power failure has occurred.</b> <ul style="list-style-type: none"> <li>• Turn off the appliance when a power failure occurs.</li> <li>• When the power is restored, wait 3 minutes, and then turn on the appliance.</li> </ul>   |
|  | <b>The voltage is too high or too low.</b> <ul style="list-style-type: none"> <li>• Check if the circuit breaker has tripped.</li> </ul>  |
|  | <b>The appliance was turned off automatically at a preset time.</b> <ul style="list-style-type: none"> <li>• Turn the appliance on.</li> </ul>  |
|  | <b>The battery orientation in the wireless remote control is incorrect.</b> <ul style="list-style-type: none"> <li>• Make sure that the batteries are inserted correctly in your wireless remote control.</li> <li>• If the batteries are placed correctly, but the appliance still does not operate, replace the batteries and try again.</li> </ul> |
|  | <b>Are the indoor unit's air inlet or outlet vents obstructed?</b> <ul style="list-style-type: none"> <li>• Remove the obstacles.</li> </ul>  |
| <b>The appliance does not emit cool air.</b> | <b>Air is not circulating properly.</b> <ul style="list-style-type: none"> <li>• Make sure that there are no curtains, blinds, or pieces of furniture blocking the front of the appliance.</li> </ul>   |
|  | <b>The air filter is dirty.</b> <ul style="list-style-type: none"> <li>• Clean the air filter once every 2 weeks.</li> <li>• See "Cleaning the Air Filter" for more information.</li> </ul>   |
|  | <b>The room temperature is too high.</b> <ul style="list-style-type: none"> <li>• In summer, cooling the indoor air fully may take some time. In this case, select the <b>Jet</b> mode to cool the indoor air quickly.</li> </ul>   |
|  | <b>The room may have been very hot when the room air conditioner was first turned on.</b> <ul style="list-style-type: none"> <li>• Allow time for it to cool down.</li> </ul>   |
|  | <b>Cold air is escaping from the room.</b> <ul style="list-style-type: none"> <li>• Make sure that no cold air is escaping through the ventilation points in the room.</li> </ul>   |
|  | <b>The desired temperature is higher than the current temperature.</b> <ul style="list-style-type: none"> <li>• Set the desired temperature to a level lower than the current temperature.</li> </ul>   |
|  | <b>There is a heating source nearby.</b> <ul style="list-style-type: none"> <li>• Avoid using heat generators like electric ovens or gas hobs while the air conditioner is in operation.</li> </ul>   |
|  | <b>Fan mode is selected.</b> <ul style="list-style-type: none"> <li>• During <b>Fan</b> mode, air blows from the appliance without cooling or heating the indoor air.</li> <li>• Switch the operating mode to a cooling operation.</li> </ul>   |
|  | <b>Outside temperature is too high.</b> <ul style="list-style-type: none"> <li>• The cooling effect may not be sufficient.</li> </ul>   |
| <b>The appliance does not emit warm air.</b> | <b>When the Heating mode starts, the vane is almost closed, and no air comes out, even though the outdoor unit is operating.</b> <ul style="list-style-type: none"> <li>• This is normal. Please wait until the appliance has generated enough warm air to blow through the indoor unit.</li> </ul>   |

| Problem  | Possible Cause & Solution   |
|--|---|
| The appliance does not emit warm air.                            | <b>The outdoor unit is in Defrosting mode.</b> <ul style="list-style-type: none"> <li>In <b>Heating</b> mode, ice and frost is built up on the coils when the outside temperature falls. The <b>Defrosting</b> mode reduces a layer of frost on the coil, and it should finish in approximately 15 minutes.</li> </ul>                |
|  | <b>Outside temperature is too low.</b> <ul style="list-style-type: none"> <li>The heating effect may not be sufficient.</li> </ul>  |
| The air conditioner changes generated airflow during operation.  | <b>When the appliance reaches the desired temperature, the airflow rate reduces in order to avoid generating cool airflow during heating, or to minimize energy consumption and indoor humidity change during cooling.</b> <ul style="list-style-type: none"> <li>This symptom is normal.</li> </ul>                                  |
| It seems that condensation is leaking from the air conditioner.  | <b>Condensation occurs when the airflow from the air conditioner cools the warm room air.</b> <ul style="list-style-type: none"> <li>This symptom is normal.</li> </ul>   |
| R32 refrigerant leakage detecting system(Optional) is activated. | <b>Are there error code such as 228, 229 and 230?</b> <ul style="list-style-type: none"> <li>Ventilate the room and contact authorized personnel immediately.</li> <li>If there is an error code of 236, the refrigerant leak detector has a lifetime of less than 6 months.<br/>Contact authorized personnel immediately.</li> </ul> |

## Performance

| Problem   | Possible Cause & Solution  |
|---|--|
| The indoor unit is still operating even when the appliance has been turned off. | <b>The Auto Clean function is being operated.</b> <ul style="list-style-type: none"> <li>Allow the <b>Auto Clean</b> function to continue since it reduces any remaining moisture inside the indoor unit. If you do not want this function, you can turn the indoor unit off.</li> </ul>   |
| The air outlet on the indoor unit is discharging mist.                          | <b>The cooled air from the appliance makes mist.</b> <ul style="list-style-type: none"> <li>When the room temperature decreases, this phenomenon will disappear.</li> </ul>  |
| Water leaks from the outdoor unit.  | <b>In the heating operations, condensed water drops from the heat exchanger.</b> <ul style="list-style-type: none"> <li>Install a drain hose under the base pan. Contact the installer.</li> </ul>   |
| There is noise or vibration.  | <b>A clicking sound can be heard when the appliance starts or stops due to movement of the reversing valve.</b><br><br><b>Creaking sound: The plastic parts of the indoor unit creak when they shrink or expand due to sudden temperature changes.</b> <ul style="list-style-type: none"> <li>Noise is normal during or after operation. It is not a sign of malfunction.</li> </ul>               |
|   | <b>Flowing sound: This is the flow of refrigerant through the appliance.</b><br><br><b>Blowing sound: This sound generates when compressed air is released into the atmosphere.</b><br><br><b>This is the sound of the dehumidifying water being processed inside the air conditioning unit.</b> <ul style="list-style-type: none"> <li>These are normal symptoms. The noise will stop.</li> </ul> |
| Crack sound is heard.   | <b>This sound is generated by the expansion or constriction of the front panel, etc. due to changes of temperature.</b> <ul style="list-style-type: none"> <li>These are normal symptoms. The noise will stop.</li> </ul>  |

| Problem   | Possible Cause & Solution  |
|---|--|
| <b>The indoor unit gives off an odor.</b>                     | <b>Odors (such as cigarette smoke) may be absorbed into the indoor unit and discharged with airflow.</b> <ul style="list-style-type: none"> <li>• If the smell does not disappear, you need to wash the filter. If this does not work, contact the service center to clean your heat exchanger.</li> </ul> |
|   | <b>Check that this is not a damp smell exuded by the walls, carpet, furniture or cloth items in the room.</b> <ul style="list-style-type: none"> <li>• If the smell comes out from walls, carpet, furniture or cloth item, clean it.</li> </ul>  |
| <b>Remote control display is faint, or no display at all.</b> | <b>Are the batteries depleted?</b> <ul style="list-style-type: none"> <li>• Replace the batteries with a new one.</li> </ul>   |
|   | <b>Are the batteries inserted in the opposite + and - directions?</b> <ul style="list-style-type: none"> <li>• Make sure that the + and - terminals of the batteries are oriented correctly.</li> </ul>  |

## Calling for Service

### Situations in which Calling for Service is Necessary

If the appliance is in one of the following situations, please call the service.

- Anything abnormal, such as a burning smell, loud noises, etc., occur;
  - Turn off the appliance and circuit breaker.
  - Never try to repair or restart the appliance yourself.
- Main power cord is too hot or damaged.
- Error code is generated by self diagnosis.
- Water leaks from the appliance even if the humidity is low.
- Any switch, circuit breaker(safety, earth) or fuse fails to work properly.

#### NOTE

- The user is responsible for routine checks and cleaning to avoid poor appliance performance.
- In cases involving unusual or special situations and circumstances servicing must be carried out only by trained service personnel.

# LIMITED WARRANTY

## USA

### LIMITED WARRANTY(USA)

The product's full Limited Warranty terms and conditions and arbitration requirements are available at <https://www.lghvac.com>.

# CANADA

## LIMITED WARRANTY(CANADA)

THE PRODUCT'S FULL LIMITED WARRANTY TERMS AND CONDITIONS ARE AVAILABLE AT [HTTPS://WWW.LGHVAC.COM](https://www.lghvac.com).

**ARBITRATION NOTICE:** THIS LIMITED WARRANTY CONTAINS AN ARBITRATION PROVISION THAT REQUIRES YOU AND LG TO RESOLVE DISPUTES BY BINDING ARBITRATION INSTEAD OF IN COURT, UNLESS THE LAWS OF YOUR PROVINCE OR TERRITORY DO NOT PERMIT THAT, OR, IN OTHER JURISDICTIONS, IF YOU CHOOSE TO OPT OUT. FOR FURTHER CLARITY, THIS ARBITRATION PROVISION IS NOT APPLICABLE TO CONSUMERS RESIDING IN ONTARIO AND QUÉBEC. IN ARBITRATION, CLASS ACTIONS AND JURY TRIALS ARE NOT PERMITTED. PLEASE SEE THE SECTION TITLED "PROCEDURE FOR RESOLVING DISPUTES" BELOW.

**DISCLAIMER:** IF YOU ARE A CONSUMER SUBJECT TO QUÉBEC AND ONTARIO'S CONSUMER PROTECTION ACT, THE EXCLUSION OF WARRANTIES CONTAINED IN THIS SECTION DO NOT EXCLUDE OR LIMIT THE RIGHTS AND REMEDIES THAT YOU MAY HAVE UNDER SUCH ACT, INCLUDING THE RIGHT TO MAKE A CLAIM UNDER ANY OF THE STATUTORY WARRANTIES PROVIDED THEREUNDER.

### PROCEDURE FOR RESOLVING DISPUTES:

EXCEPT WHERE PROHIBITED AT LAW (INCLUDING WITH RESPECT TO QUÉBEC AND ONTARIO CONSUMERS), ALL DISPUTES BETWEEN YOU AND LG ARISING OUT OF OR RELATING IN ANY WAY TO THIS LIMITED WARRANTY OR THE PRODUCT SHALL BE RESOLVED EXCLUSIVELY THROUGH BINDING ARBITRATION, AND NOT IN A COURT OF GENERAL JURISDICTION. EXCEPT WHERE PROHIBITED AT LAW (INCLUDING WITH RESPECT TO QUÉBEC AND ONTARIO CONSUMERS), YOU AND LG BOTH IRREVOCABLY AGREE TO WAIVE THE RIGHT TO A JURY TRIAL AND TO BRING OR PARTICIPATE IN A CLASS ACTION.

**Definitions.** For the purposes of this section, references to "LG" mean LG Electronics Canada, Inc., its parents, subsidiaries and affiliates, and each of their officers, directors, employees, agents, beneficiaries, predecessors in interest, successors, assigns and suppliers; references to "dispute" or "claim" shall include any dispute, claim or controversy of any kind whatsoever (whether based in contract, tort, statute, regulation, ordinance, fraud, misrepresentation or any other legal or equitable theory) arising out of or relating in any way to the sale, condition or performance of the product or this Limited Warranty.

**Notice of Dispute.** In the event you intend to commence an arbitration proceeding, you must first notify LG in writing at least 30 days in advance of initiating the arbitration by sending a letter to LGECI Legal Team at 20 Norelco Drive, North York, Ontario, Canada M9L 2X6 (the "Notice of Dispute"). You and LG agree to engage in good faith discussions in an attempt to amicably resolve your claim. The notice must provide your name, address, and telephone number; identify the product that is the subject of the claim; and describe the nature of the claim and the relief being sought. If you and LG are unable to resolve the dispute within 30 days of LG's receipt of the Notice of Dispute, the dispute shall be resolved by binding arbitration in accordance with the procedure set out herein. You and LG both agree that, during the arbitration proceeding, the terms (including any amount) of any settlement offer made by either you or LG will not be disclosed to the arbitrator until the arbitrator determines the dispute.

**Agreement to Binding Arbitration and Class Action Waiver.** Upon failure to resolve the dispute during the 30 day period after LG's receipt of the Notice of Dispute, you and LG agree to resolve any claims between you and LG only by binding arbitration on an individual basis, unless you opt out as provided below, or you reside in a jurisdiction that prevents full application of this clause in the circumstances of the claims at issue (in which case if you are a consumer, this clause will only apply if you expressly agree to the arbitration). To the extent permitted by applicable law, any dispute between you and LG shall not be combined or consolidated with a dispute involving any other person's or entity's product or claim. More specifically, without limitation of the foregoing, except to the extent such a prohibition is not permitted at law, any dispute between you and LG shall not under any circumstances proceed as part of a class or representative action. Instead of arbitration, either party may bring an individual action in small claims court, but that small claims court action may not be brought on a class or representative basis except to the extent this prohibition is not permitted at law in your province or territory of jurisdiction as it relates to the claims at issue between you and LG. This does not apply to consumers in Ontario and Québec. In accordance with provincial legislation, the consumer and LG may agree to resolve the dispute using any procedure available, including commencing the action before the competent courts of those provinces.

**Arbitration Rules and Procedures.** To begin arbitration of a claim, either you or LG must make a written demand for arbitration. The arbitration will be private and confidential, and conducted on a simplified and

expedited basis before a single arbitrator chosen by the parties under the provincial or territorial commercial arbitration law and rules of the province or territory of your residence. You must also send a copy of your written demand to LG at LG Electronics, Canada, Inc., Attn: Legal Department- Arbitration, 20 Norelco Drive, North York, Ontario M9L 2X6. This arbitration provision is governed by your applicable provincial or territorial commercial arbitration legislation. For consumers in Ontario and Québec, the applicable arbitration legislation only applies if consumers agree to submit the dispute to arbitration. Judgment may be entered on the arbitrator's award in any court of competent jurisdiction. All issues are for the arbitrator to decide, except that, issues relating to the scope and enforceability of the arbitration provision and to the arbitrability of the dispute are for the court to decide. The arbitrator is bound by the terms of this provision.

**Governing Law.** The law of the province or territory of your purchase shall govern this Limited Warranty and any disputes between you and LG except to the extent that such law is preempted by or inconsistent with applicable federal or provincial/territorial law. Should arbitration not be permitted for any claim, action, dispute or controversy between you and LG, you and LG attorn to the exclusive jurisdiction of the courts of the province or territory of your purchase for the resolution of the claim, action, dispute or controversy between you and LG.

**Fees/Costs.** You do not need to pay any fee to begin an arbitration. Upon receipt of your written demand for arbitration, LG will promptly pay all arbitration filing fees unless you seek more than \$25,000 in damages, in which case the payment of these fees will be governed by the applicable arbitration rules. Except as otherwise provided for herein, LG will pay all filing, administration and arbitrator fees for any arbitration initiated in accordance with the applicable arbitration rules and this arbitration provision. If you prevail in the arbitration, LG will pay your attorneys' fees and expenses as long as they are reasonable, by considering factors including, but not limited to, the purchase amount and claim amount. Notwithstanding the foregoing, if applicable law allows for an award of reasonable attorneys' fees and expenses, an arbitrator can award them to the same extent that a court would. If the arbitrator finds either the substance of your claim or the relief sought in the demand is frivolous or brought for an improper purpose (as measured by the applicable laws), then the payment of all arbitration fees will be governed by the applicable arbitration rules. In such a situation, you agree to reimburse LG for all monies previously disbursed by it that are otherwise your obligation to pay under the applicable arbitration rules. Except as otherwise provided for, LG waives any rights it may have to seek attorneys' fees and expenses from you if LG prevails in the arbitration.

**Hearings and Location.** If your claim is for \$25,000 or less, you may choose to have the arbitration conducted solely (1) on the basis of documents submitted to the arbitrator, (2) through a telephonic hearing, or (3) by an in-person hearing as established by the applicable arbitration rules. If your claim exceeds \$25,000, the right to a hearing will be determined by the applicable arbitration rules. Any in-person arbitration hearings will be held at the nearest, most mutually-convenient arbitration location available within the province or territory in which you reside unless you and LG both agree to another location or agree to a telephonic arbitration.

**Severability and Waiver.** If any portion of this Limited Warranty (including these arbitration procedures) is unenforceable, the remaining provisions will continue in full force and effect to the maximum extent permitted by applicable law. Should LG fail to enforce strict performance of any provision of this Limited Warranty (including these arbitration procedures), it does not mean that LG intends to waive or has waived any provision or part of this Limited Warranty.

**Opt Out.** The arbitration provision requires you and LG to resolve disputes by binding arbitration instead of court, unless the laws of your province or territory do not permit that, or, in other jurisdictions, if you choose to opt out. The arbitration provision does not apply to consumers in Ontario and Québec.

For individuals that fall within the binding arbitration provisions, you may opt out of this dispute resolution procedure. If you opt out, neither you nor LG can require the other to participate in an arbitration proceeding. To opt out, you must send notice to LG no later than 30 calendar days from the date of the first consumer purchaser's purchase of the product by either (i) sending an e-mail to [optout@lge.com](mailto:optout@lge.com), with the subject line: "Arbitration Opt Out;" or (ii) calling 1-800-980-2973. You must include in the opt out e-mail or provide by telephone: (a) your name and address; (b) the date on which the product was purchased; (c) the product model name or model number; and (d) the serial number (the serial number can be found (i) on the product; or (ii) online by accessing [https://www.lg.com/ca\\_en/findmodel\\_serial/](https://www.lg.com/ca_en/findmodel_serial/)).

In the event that you "Opt Out", the law of the province or territory of your residence shall govern this Limited Warranty and any disputes between you and LG except to the extent that such law is preempted by or inconsistent with applicable federal or provincial/territorial law. Should arbitration not be permitted

---

for any claim, action, dispute or controversy between you and LG, you and LG agree to attorn to the exclusive jurisdiction of the courts of the province or territory of your residence for the resolution of the claim, action, dispute or controversy between you and LG.

You may only opt out of the dispute resolution procedure in the manner described above (that is, by e-mail or telephone); no other form of notice will be effective to opt out of this dispute resolution procedure. Opting out of this dispute resolution procedure will not affect the coverage of the Limited Warranty in any way, and you will continue to enjoy the full benefits of the Limited Warranty. If you keep this product and do not opt out, then you accept all terms and conditions of the arbitration provision described above.

**Conflict of Terms.** In the event of a conflict or inconsistency between the terms of this Limited Warranty and the End User License Agreement (“EULA”) in regards to dispute resolution, the terms of this Limited Warranty shall control and govern the rights and obligations of the parties and shall take precedence over the EULA.





|        |   |
|--------|---|
| US     | Please call the installing contractor of your product, as warranty service will be provided by them.                  |
| CANADA | Service Call Number: (888) LG Canada, (888) 542-2623<br>Numéro pour les appels de service : LG Canada, 1-888-542-2623 |