

Features

- For use with the K-3950 Tresham two-piece toilet
- Coordinates with other products in the Tresham collection

Material

- Premium metal construction for durability and reliability
- KOHLER finishes resist corrosion and tarnishing

Recommended Products/Accessories

K-23723 Faucet cleaner



ADA

CSA B651

OBC

Codes/Standards

ASME A112.18.1/CSA B125.1

ADA

ICC/ANSI A117.1

CSA B651







OBC

KOHLER® One-Year Limited Warranty

See website for detailed warranty information.

Available Colors/Finishes

Color tiles intended for reference only.

Color	Code	Description
	SN	Vibrant™ Polished Nickel
	AF	Vibrant™ French Gold
	BN	Vibrant™ Brushed Nickel
	BV	Vibrant™ Brushed Bronze
	2BZ	Oil-Rubbed Bronze
	2MB	Vibrant™ Brushed Moderne Brass

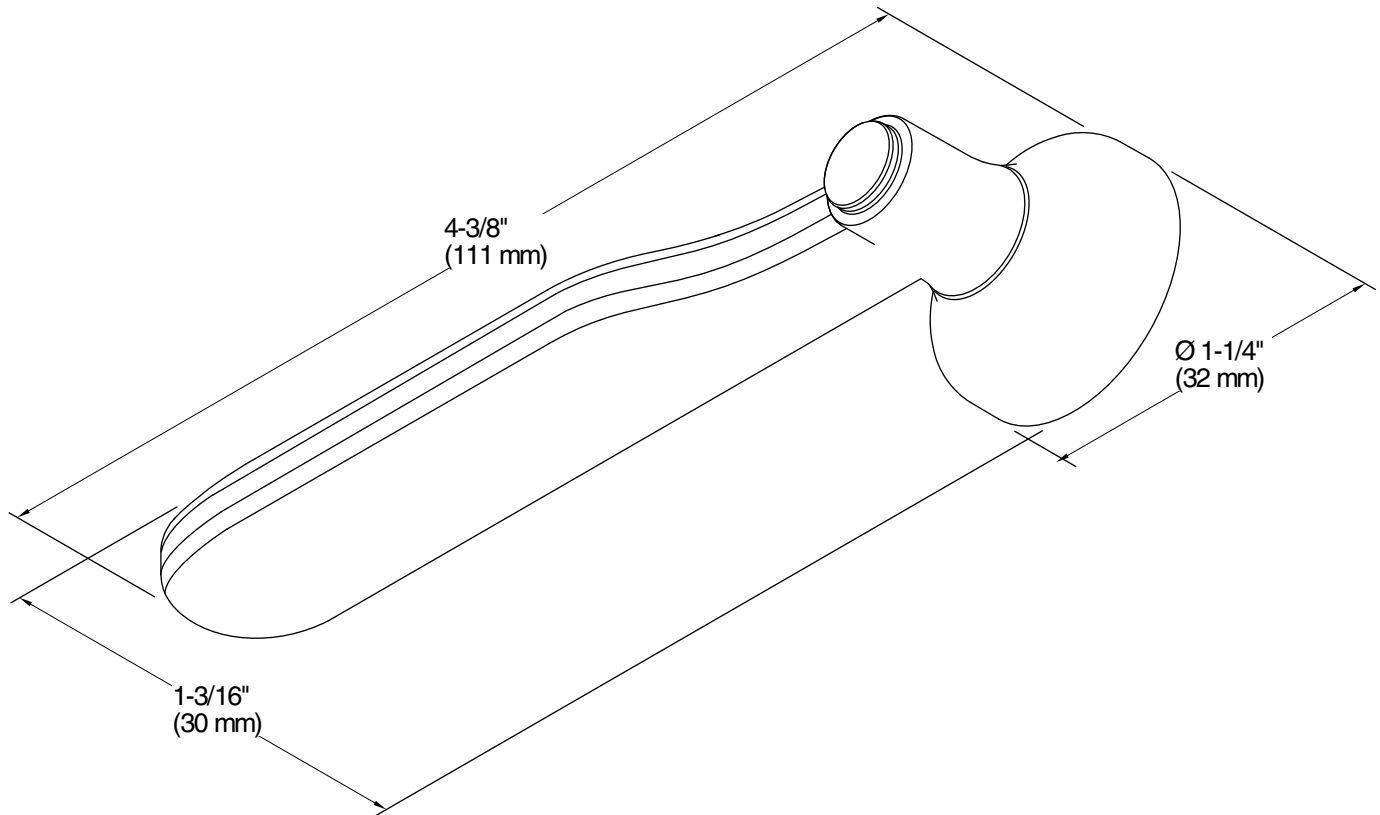

Technical Information

All product dimensions are nominal.

Material: Metal

Notes

ADA, OBC, CSA B651 compliant when installed to the specific requirements of these regulations.