

Features

- High-arch spout with 360° spout rotation offers superior clearance for filling pots and cleaning.
- KOHLER ceramic disc valves exceed industry longevity standards for a lifetime of durable performance.
- Single lever handle is simple to use and makes adjusting water temperature easy.
- Temperature memory allows faucet to be turned on and off at the temperature set during prior usage.
- 1.5 gpm (5.7 lpm) maximum flow rate at 60 psi (4.14 bar).

Material

- Premium metal construction for durability and reliability.
- KOHLER finishes resist corrosion and tarnishing.

Installation

- Single-hole installation (three-hole escutcheon sold separately).
- Flexible supply lines simplify installation.
- Available with 7" (178mm) swing spout reach.

Adapters, Rough-in and Extension Kits

1012715	Range: 3-1/4" (83 mm) - 5-3/8" (137 mm)
1030920	Range: 2-5/8" (67 mm) - 3-3/4" (95 mm)

Recommended Products/Accessories

K-99272 Three-Hole Kitchen Faucet Escutcheon
K-77685 Single-Cartridge Water Filtration System
K-77686 Double-Cartridge Water Filtration System
K-77687 single replacement filter cartridge
K-77688 Replacement Filter Cartridges, Two-Pack
K-23723 Faucet cleaner

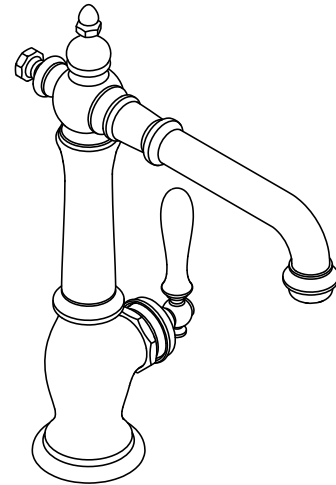

ADA

CSA B651

Codes/Standards





ASME A112.18.1/CSA B125.1
NSF/ANSI 61
NSF/ANSI 372
All applicable US Federal and State material regulations
DOE - Energy Policy Act 1992
California Energy Commission (CEC)
ADA
ICC/ANSI A117.1
CSA B651

KOHLER® Faucet Lifetime Limited Warranty

See website for detailed warranty information.

Available Colors/Finishes

Color tiles intended for reference only.

Color	Code	Description
	CP	Polished Chrome
	SN	Vibrant® Polished Nickel
	VS	Vibrant® Stainless
	2BZ	Oil-Rubbed Bronze
	2MB	Vibrant® Brushed Moderne Brass

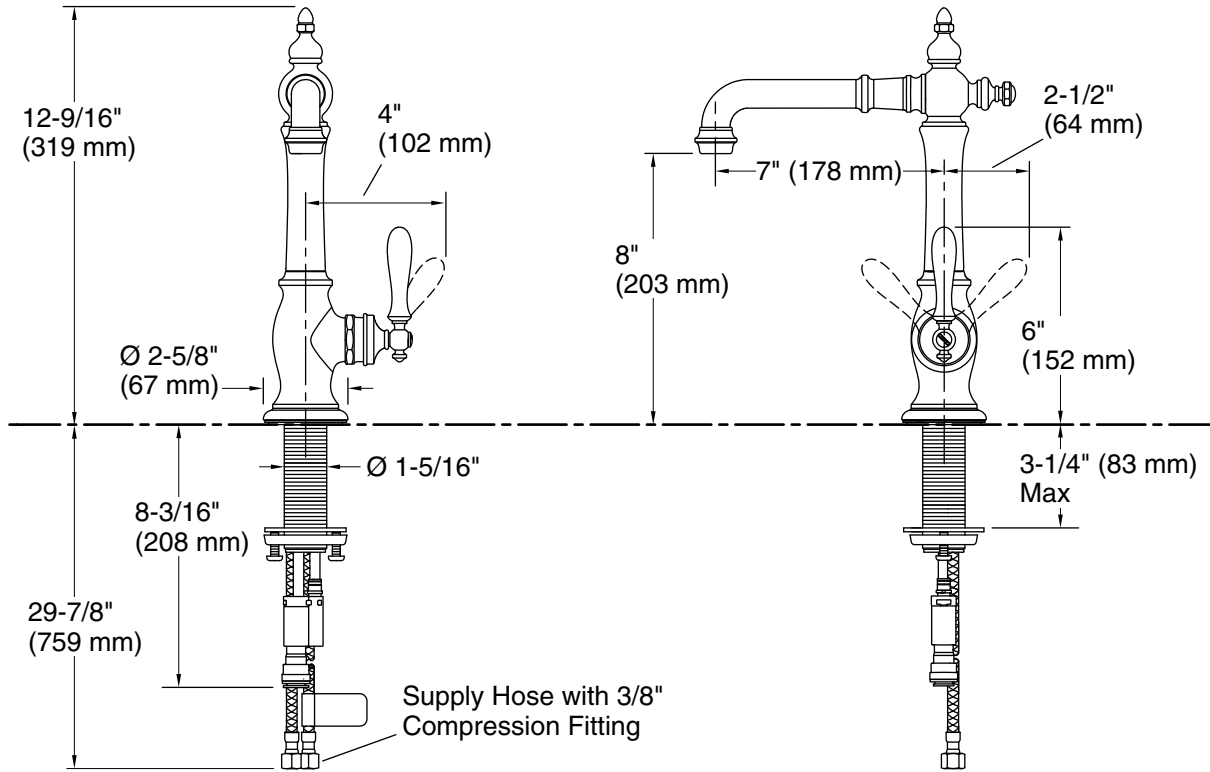

Technical Information

All product dimensions are nominal.

Spout:

Spout reach: 7" (178 mm)

Notes

Install this product according to the installation guide.

ADA, CSA B651 compliant when installed to the specific requirements of these regulations.