

Features

- 21" (533 mm) minimum base cabinet width
- Single bowl
- 9" (229 mm) depth provides generous workspace
- Rear drain placement increases cabinet storage space underneath sink
- Rounded 3/8" (10 mm) corners are easy to clean
- Matte finish offers rich, dimensional color

Material

- KOHLER Neoroc® composite is durable and built to withstand day-to-day cleaning tasks
- Solid color throughout the sink
- Heat-resistant up to 750°F
- Scratch-, stain-, chip-, and thermal-shock-resistant

Installation

- Undermount
- Installation hardware and templates included

Recommended Products/Accessories

- K-35478 Three-piece workstation sink accessory set
- K-35480 Hardwood cutting board
- K-35489 Professional-style cutting board
- K-35484 Three-piece workstation sink prep bowl set
- K-35491 Marble serving tray
- K-35487 Three-piece ice bucket set
- K-35488 Ice bucket holder
- K-35492 Bar sink cover
- K-23730 Neoroc® cleaner
- K-37917-WAL Colander
- K-37918-WAL Soaking bin
- K-37922-WAL Three-piece salad bowl set
- K-37923-WAL Pot rack
- K-37914-WAL Three-piece workstation sink prep bowl set

Optional Products/Accessories

- K-23726 Drain treatment
- K-8799 Sink drain and strainer basket
- K-8801 Sink drain and strainer with tailpiece
- K-35482 Drain cover

Included Components

- K-33717 Sink rack



Codes/Standards







CSA B45.5/IAPMO Z124

KOHLER® Neoroc® Sinks Lifetime Limited Warranty

See website for detailed warranty information.

Available Colors/Finishes

Color tiles intended for reference only.

Color	Code	Description
	CM7	Matte Graphite
	CM6	Matte White
	CM4	Matte Grey
	CM2	Matte Brown
	CM1	Matte Black
	CM3	Matte Taupe

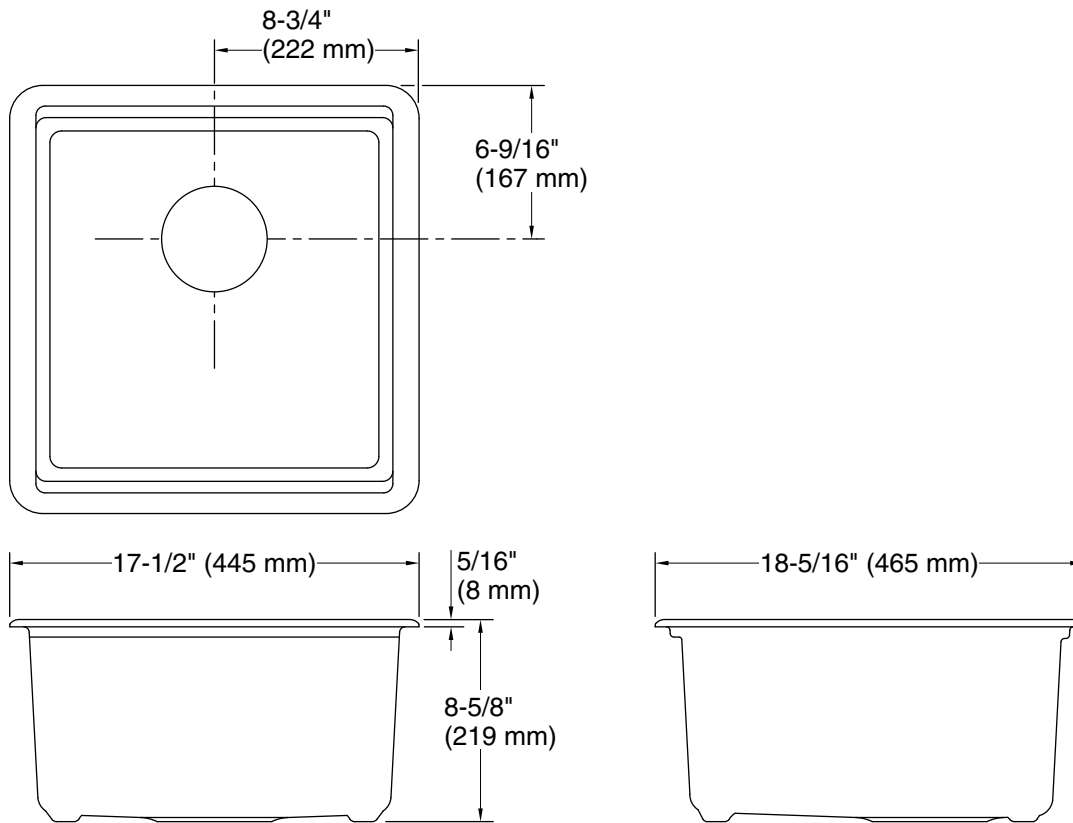

Technical Information

All product dimensions are nominal.

Basin configuration: Single Bowl
Min. base cabinet width: 21" (533 mm)

Bowl area (Basin #1):
Length: 15-1/4" (387 mm)
Width: 15-9/16" (395 mm)
Bowl depth: 8" (203 mm)
Water depth: 8" (203 mm)

With overflow: No

Drain hole: 3-7/8" (98 mm)

Template: Undermount, 1559205-7, required, included

Notes

Install this product according to the installation instructions.